



**I prezzi indicati nella brochure,
sono comprensivi di posa con
manodopera specializzata.
Trasporto entro 30km da Rimini,
oltre verrà applicata
un supplemento in base a km .**

è lieta di potervi presentare:

La nostra nuova gamma di articoli:

**PAVIMENTAZIONE IN SPC, PANNELLI ACUSTICI IN
MDF e DECKING IN COMPOSITO PER ESTERNI.**

Simile ad altre forme di pavimentazione vinilica di lusso, elegante e raffinata, la pavimentazione SPC è stratificata e riproduce l'esperienza autentica del legno o della ceramica in tutte le sue gradazioni cromatiche.

Il suddetto Nucleo centrale della pavimentazione garantisce una maggiore durata e funge da base solida per tutto il resto del pavimento.

**La pavimentazione SPC è senza dubbio una delle
soluzioni di pavimentazione più durevoli disponibili.**

I migliori pavimenti SPC hanno anche strati di usura premium con una maggiore resistenza ad ammaccature; di conseguenza, l'SPC è la scelta migliore per gli appartamenti, se si hanno animali domestici o bambini, per gli uffici locali commerciali o semplicemente se si è alla ricerca di un **design sofisticato moderno e dalla facile installazione.**

SPC Pavimentazione

Puoi massimizzare il comfort nei tuoi spazi abitativi con i vantaggi dell'utilizzo dei rivestimenti SPC STRATIFICATI.

Composito di Polimeri Polvere di Pietra con le sue opzioni, si distingue come la tecnologia più innovativa sul mercato.

Per le categorie con grado usura 0,55 è possibile realizzare pezzi speciali per gradini su richiesta.

TIPI DI MONTAGGIO

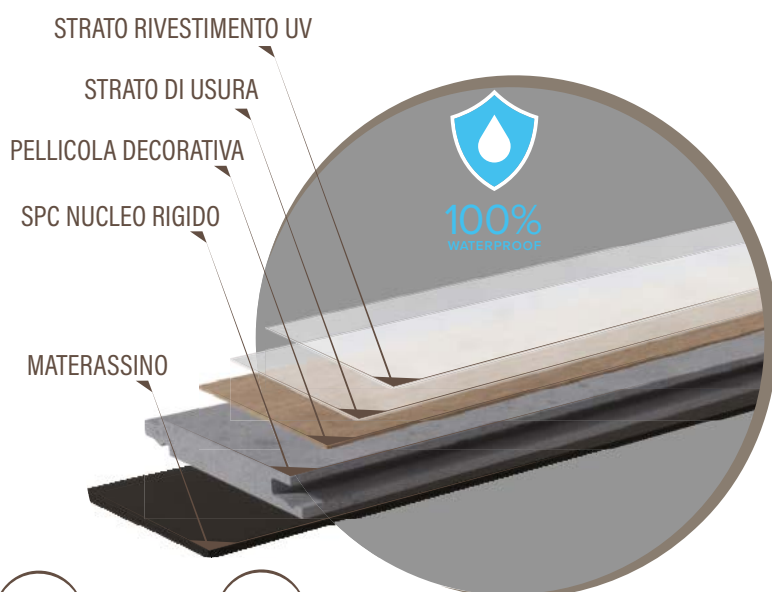
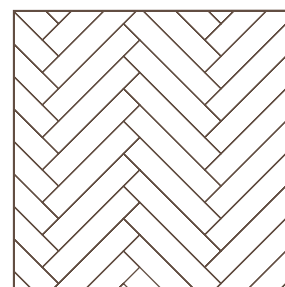
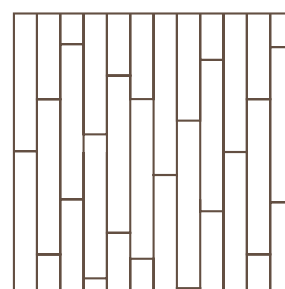



FRANCESCA

Origine Collection
SPC FLOORING



TAVOLA /



PLANK
228 X 1220 X 4+1 mm

CONFEZIONE

9 X 
=2.503 m²
=20.38 Kg

PEDANA

44 X 
=110.151 m²
=916.61 Kg

PREZZO

€ 44.20 MQ

GRADO DI USURA 0,30

codice

201-WD



codice

203-WD



codice

204-WD



codice

205-WD



codice

206-WD



codice

207-WD



codice

208-WD



codice

209-WD



codice

210-WD



Grado usura: 0,55



ERIKA

Origine Collection
SPC FLOORING



TAVOLA /





CONFEZIONE

PEDANA

PREZZO

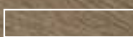
PLANK
228 X 1220 X 4+1 mm

9 X 
=2.503 m²
=20.38 Kg

44 X 
=110.151 m²
=916.61 Kg

€ 49.00 MQ

TAVOLA /



CONFEZIONE

PEDANA

PREZZO



SPINA DI PESCE
150 X 600 X 4+1 mm

16 X 
=1.440 m²

44 X 
=103.68 m²

€ 52.50 MQ

codice

101-0G *



**DISPONIBILI ANCHE NELLA VERSIONE 150X600 MM SP. 5MM CF. 1.440MQ PER POSA A SPINA DI PESCE*

codice

102-0G *



**DISPONIBILI ANCHE NELLA VERSIONE 150X600 MM SP. 5MM CF. 1.440MQ PER POSA A SPINA DI PESCE*

codice

104-0G *



**DISPONIBILI ANCHE NELLA VERSIONE 150X600 MM SP. 5MM CF. 1.440MQ PER POSA A SPINA DI PESCE*

codice
105-0G



codice
106-0G



codice
108-0G





JESSICA

Origine Collection
SPC FLOORING



TAVOLA /



CONFEZIONE

PEDANA

PREZZO

PLANK

228 X 1220 X 5+1mm

7 X 
=1.947 m²
=19.82 Kg

44 X 
=85.673 m²
=892.13 Kg

€ 54.40 MQ

Grado usura: 0,55

codice

111-301-DM

A close-up photograph of a light-colored wood surface, likely oak, showing a prominent grain pattern and several dark knots. The wood is oriented horizontally.

codice

111-302-DM

A close-up photograph of a light-colored wood surface, likely oak, showing a prominent grain pattern and several dark knots. The wood is oriented horizontally.

codice

111-303-DM

A close-up photograph of a light-colored wood surface, likely oak, showing a prominent grain pattern and several dark knots. The wood is oriented horizontally.

codice

111-304-DM



codice

111-305-DM



codice

111-306-DM



codice

111-308-DM



codice

111-310-DM





MICHELLE

Origine Collection
SPC FLOORING



TAVOLA /



PLANK
228 X 1220 X 5+1,5mm

CONFEZIONE

7 X 
=1.947 m²
=19.82 Kg

PEDANA

44 X 
=85.673 m²
=892.13 Kg

PREZZO

€ 58.00 MQ

Grado usura: 0,55

codice

501-AC

codice
502-AC



codice
503-AC



codice
504-AC



codice

505-AC



codice

506-AC



codice

507-AC



codice

507-AC-2



codice

508-AC



codice

510-AC





KRISTAL

Grado usura: 0,30

NOVITA' PAVIMENTAZIONE

305 x 600 x 4+1 mm

Grado di Usura 0.50

9 PZ = 1.647 Mq PED 108.712

€ 45.60 MQ

NOVITA' RIVESTIMENTO

305 x 600 x 4 mm



Grado di Usura 0.50

11 PZ = 2.013 Mq PED. 108.702 MQ

€ 45.60 MQ

SPC PAVIMENTAZIONE



EFFETTO MARMO E PIETRA

TAVOLA / 	PLANK 305 X 1220* X 4+1 mm
CONFEZIONE	6 X  =2.233 m ² =18.26 Kg
PEDANA	48 X  =107.165 m ² =896.52 Kg
PREZZO	€ 45.60 MQ

PAVIMENTAZIONE : CON MATERASSINO

SPC RIVESTIMENTO

EFFETTO MARMO E PIETRA

TAVOLA / 	PLANK 305 X 610 X 4 mm
CONFEZIONE	9 X  =2.047 m ² =13.70 Kg
PEDANA	66 X  =159.66 m ² =923.911 Kg
PREZZO	€ 45.60 MQ

RIVESTIMENTO : SENZA MATERASSINO

* Formato disp. fino ad esaurimento scorte

Codice Pavimentazione

801

Codice Rivestimento

801 R



Codice Pavimentazione

802

Codice Rivestimento

802 R



Codice Pavimentazione

803

Codice Rivestimento

803 R



Codice Pavimentazione

804

Codice Rivestimento

804 R



Codice Pavimentazione

805

Codice Rivestimento

805 R



Codice Pavimentazione

806

Codice Rivestimento

806 R



Codice Pavimentazione

808

Codice Rivestimento

808R



BATTISCOPA IN PVC ESPANSO

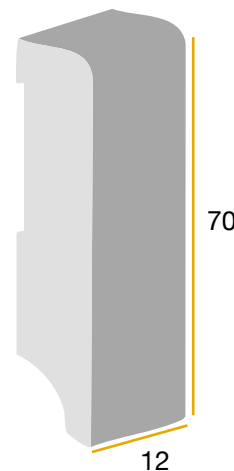
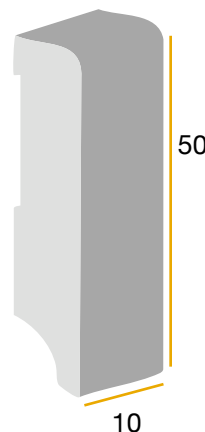
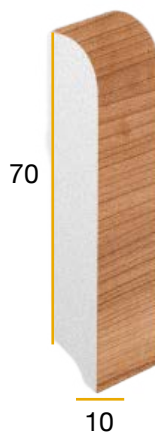

BATTISCOPA PVC ESPANSO

con carta digitale ad alta resistenza (AC4)

CODICE ARTICOLO: BTE-T

Altezza 70mm

Larghezza base 10mm

Confezione: 24ml

Barre da 2,40ml

PREZZO ML: 9,60 €

I colori del battiscopa BTE-T sono disponibili in tutti i colori delle collezioni di pavimentazione e rivestimento in SPC.

CODICE ARTICOLO: BTE-Q

Altezza 70mm

Larghezza base 12mm

Confezione: 24ml

Barre da 2,40ml

Colore: Bianco

PREZZO ML: 9,60 €

CODICE ARTICOLO: BTE-QP

Altezza 50mm

Larghezza base 10mm

Confezione: 24ml

Barre da 2,40ml

Colore: Bianco

PREZZO ML: 8,65 €



ECO Battiscopa PVC



Con i nostri battiscopa in PVC Riciclato potrai rifinire la tua casa e aggiungere facilmente bellezza ai tuoi spazi.
Disponibili in diversi colori e nella versione SQUARE O ROUND con rispettivi accessori.

TABELLA COLORI SQUARE E ROUND

1	2	3	4	5	6	7
						
bianco ral 9003	bianco ral 9010	rovere neve	ecrù	pigalle	cedar	cener
8	9	10	11	12	13	14
						
rovere crema	brush	rovere fumo	rovere cioccolato	noce nazionale	rovere curry	rovere albicocca
15	16	17				
						
argento	nero opaco	rovere ghiaccio				

BATTISCOPA QUADRO



BATTISCOPA SQUARE ECO

Battiscopa PVC riciclato 70

Altezza 70mm | Larghezza base 14mm

Spessore 2mm

Confezione: 25mt. | Barre da 2,5mt.

CODICE ARTICOLO: P1ECO

PREZZO ML: 7,20 €

è possibile realizzare angoli pre tagliati interni ed esterni effettuando tagli a 45°

BATTISCOPA TONDO



BATTISCOPA ROUND ECO

Battiscopa PVC riciclato 70

Altezza 70mm | Larghezza base 12mm

Spessore 2mm

Confezione: 25mt. | Barre da 2,5mt.

CODICE ARTICOLO: P2ECO

PREZZO ML: 7,20 €

è possibile realizzare angoli pre tagliati interni ed esterni effettuando tagli a 45°

GIUNTI DI DILATAZIONE E DELIMITAZIONE PER SPC

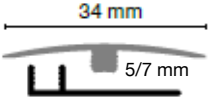
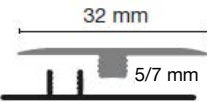
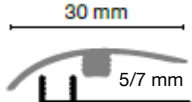
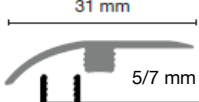
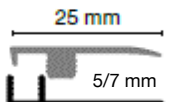
DESCRIZIONE PRODOTTO	FINITURA	LUNGH. MM.	CONF. ML	€ KIT/ML
Giunto di dilatazione diritto da 34 mm o da 32 mm in alluminio forma piana o curva + base PVC antiurto.	Anodizzato Satinato	2700	32,4 ml	€/ml 15,40
 Cod: GIU34C	*Rivestito carta digitale alta resistenza come collezioni pavimento e rivestimento.	2700	32,4 ml	€/ml 24,00
 Cod: GIU32P				
Kit profilo di dilatazione terminale da 30mm o 31mm in alluminio forma piana o curva + base PVC antiurto.	Anodizzato Satinato	2700	32,4 ml	€/ml 15,40
 Cod: TER30	*Rivestito carta digitale alta resistenza come collezioni pavimento e rivestimento.	2700	32,4 ml	€/ml 24,00
 Cod: TER31				
Kit profilo di dilatazione perimetrale da 25mm in alluminio + base pvc antiurto.	Anodizzato Satinato	2700	32,4 ml	€/ml 15,40
 Cod: PER25	*Rivestito carta digitale alta resistenza come collezioni pavimento e rivestimento.	2700	32,4 ml	€/ml 24,00

N.B.: I colori dei giunti di dilatazione sono disponibili in tutti i colori delle collezioni di pavimentazione e rivestimento in SPC.

* Quantità minima 12 barre.

PROFILI IN ALLUMINIO PER SCALE

PZA66A: PARAGRADINO ZIGRINATO 6X6X3000 MM
€/ml 20.70

PRA66A: PARAGRADINO PER LVT 6X6X2700 MM
€/ml 20.70

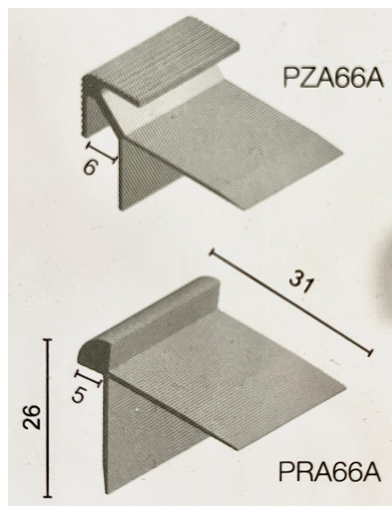



CONSIGLI PER LA POSA

Su superficie planare, in caso di posa su pavimento con fuga oltre i 2 mm è consigliata la rasatura delle fughe con articolo **LVT LEVELLER**, attendere che sia asciutto (2 ore circa), carteggiare e proseguire con la posa.

E' indispensabile lasciare sul perimetro 5/6 mm di tolleranza, in modo che il pavimento resti flottante.

In caso di infissi, utilizzare il profilo **KIT PROFILO DI DILATAZIONE PERIMETRALE PER25**, idoneo anche in caso non venga rimosso, il battiscopa esistente.

E' consigliabile utilizzare profili terminali curvi per delimitare il pavimento, tale profilo inoltre, funge anche da protezione.

Su ampie superfici, è consigliabile il giunto di dilatazione **GIU34 C**.

Dopo la posa, aspirare la polvere e lavare con detergente **EC56**.

Il pavimento è corredato del suo tappetino, direttamente pronto per la posa.

Le **PIASTRELLE IN SPC** offrono performance straordinarie in termini di resistenza, impermeabilità e durata. Estremamente silenzioso al calpestio, facile da installare con il suo sistema ad incastro perfetto.

L'SPC unisce performance e bellezza ai tuoi spazi.

Restituisce una perfetta corrispondenza tra sfera visiva e tattile.

Lo strato di usura funge da scudo per proteggere il pavimento da danni minimi (vale a dire, un pavimento resistente ad ammaccature e graffi).

PANNELLO DA PARETE ACUSTICO IN MDF

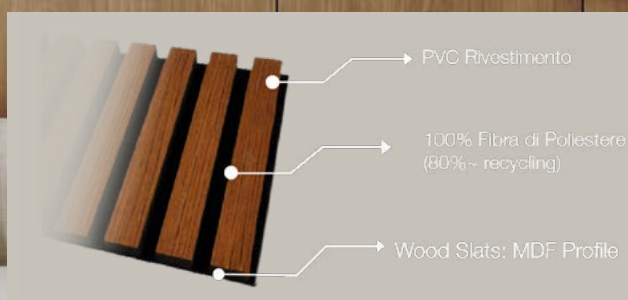

Con i pannelli murali acustici in MDF potrai godere di:
INSONORIZZAZIONE, CALORE, DESIGN ESTETICO DAL CARATTERE UNICO.

TECHNICAL DATA SHEET

:: 0.18mm x 1,430mm Textured Wood and Solid

:: Formula Contains:

- 1) PVC Resin Powder 79%
- 2) Stabilizer 2%
- 3) Lubricant 1%
- 4) Additives 6%
- 5) Pigments 4%
- 6) CaCo3 3%
- 7) DINP 5% (Plasticizer)



Main Ingredient: PVC

Appearance: Solid Sheet

PH: NA

Melting Point: NA

Boiling Point: NA

Relative Density: 1.30 - 1.50

Relative Density of Steam: NA

Saturated Vapor Pressure: NA

Heat of Combustion: ND

Critical Temperature: NA

Critical Pressure: NA

Flash Point: ND

Ignition Temperature: >780 C

NB: IL COSTO DEL TRASPORTO VIENE CALCOLATO IN FASE DI ORDINE

PANNELLO MDF SUPERIOR

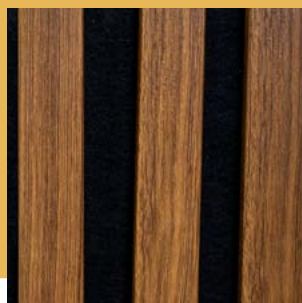
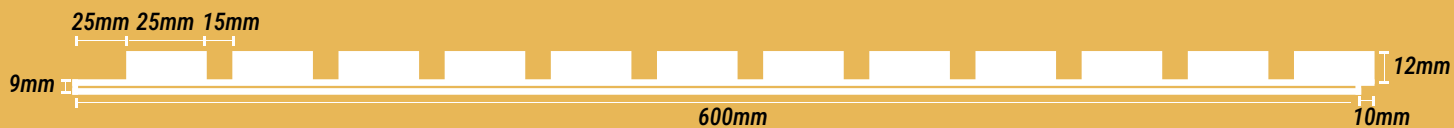

NATURALE - T



GRIGIO - G

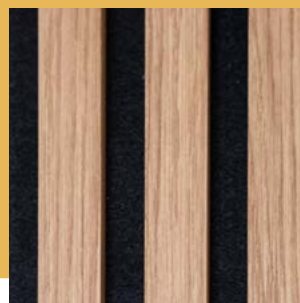

QUERCIA - N

LUNGHEZZA PANNELLO: 2800 mm | LARGHEZZA PANNELLO: 600 mm | PACK 5 PANNELLI |
PREZZO 192 €/PZ

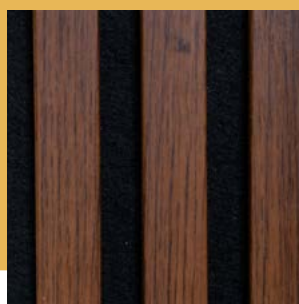

NOCE - A



FAGGIO

PANNELLO MDF SMART

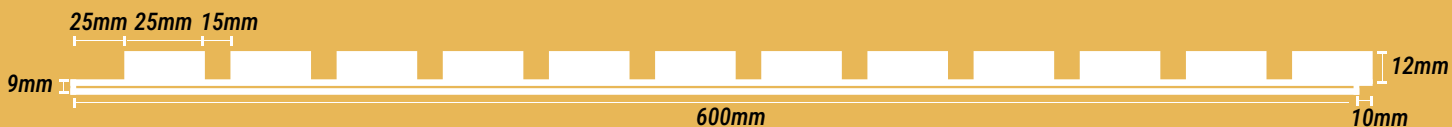

C - NATURALE



C - GRIGIO



C - QUERCIA

LUNGHEZZA PANNELLO: 2800 mm | LARGHEZZA PANNELLO: 600 mm | PACK 2 PANNELLI |
PREZZO 120 €/PZ

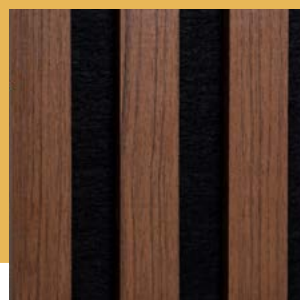

C - NOCE



C - FAGGIO

PANNELLO MDF SLIM

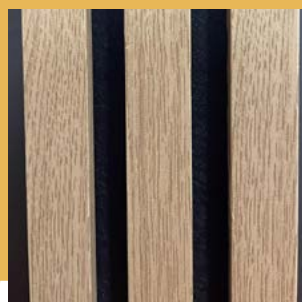
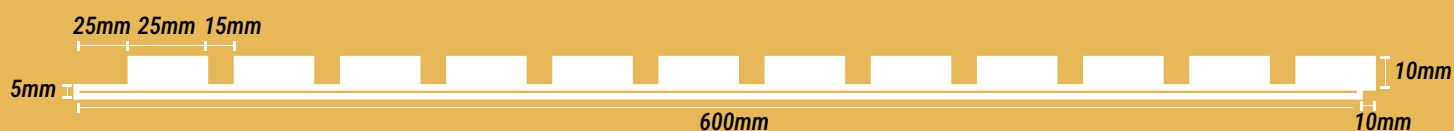

ROVERE

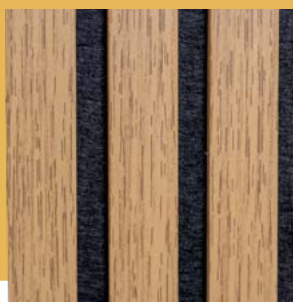

FRASSINO

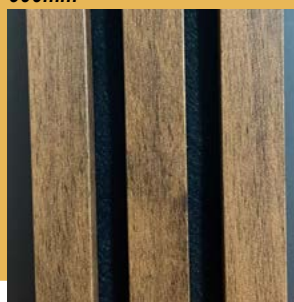

CASTAGNO

LUNGHEZZA PANNELLO: 2800 mm | LARGHEZZA PANNELLO: 600 mm | PACK 3 PANNELLI |
PREZZO 144 €/PZ

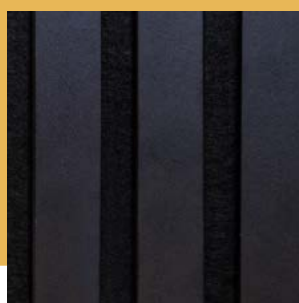

NERO



ABETE

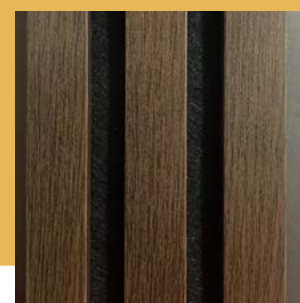

WENGÈ

PANNELLO MDF ARROTOLABILE

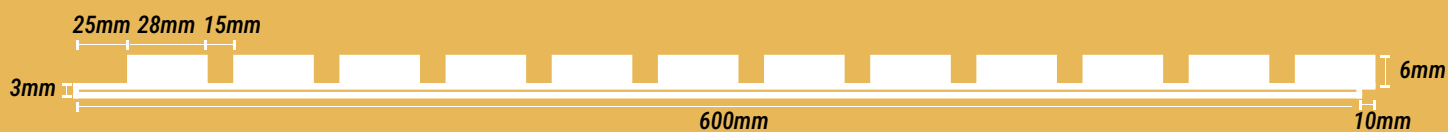

GRIGIO - A



PINO - A



ECRÙ - A

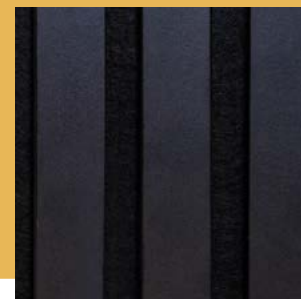

NERO - A

LUNGHEZZA PANNELLO: 2800 mm | LARGHEZZA PANNELLO: 600 mm | PACK 3 PANNELLI |
PREZZO 144 €/PZ



PAVIMENTAZIONE PER ESTERNI

DECKING LEGNO
COMPOSITO E NATURALE



Tabella Colori

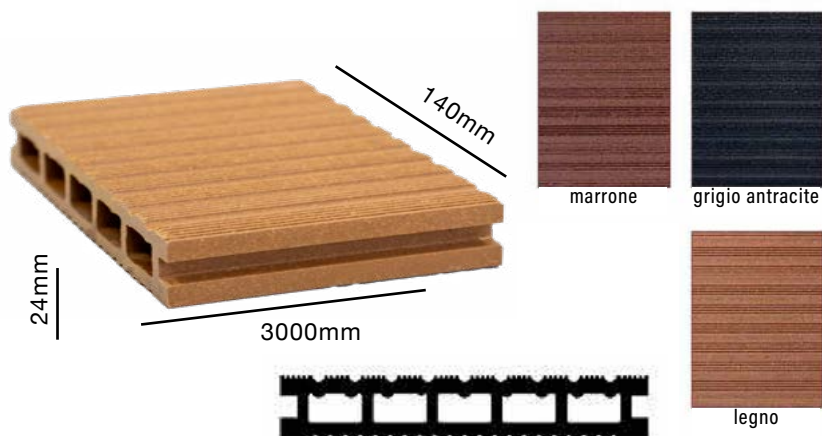

DECKING LEGNO COMPOSITO E NATURALE

Altezza 24mm | Larghezza 140mm

Lunghezza 3000mm

Mq 0.42

CODICE ARTICOLO: D02 ...

PREZZO PZ: 49,80 €

3m² sono composti da
7 decking da 300ml + 4 listelli da 300ml
+ 84 clips

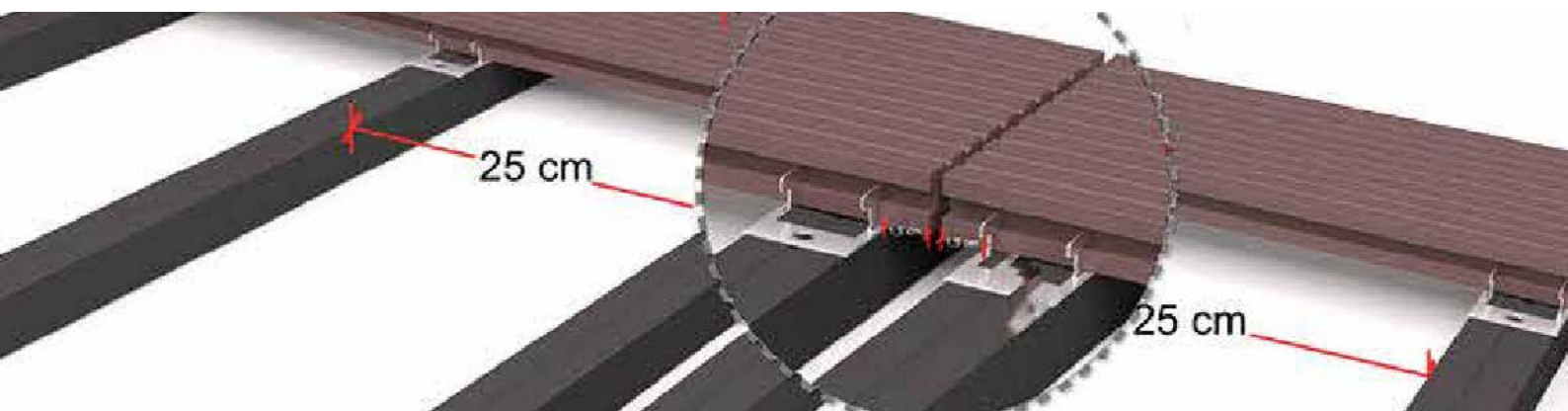

ANGOLARE PER GRADINO

COD: APG

Altezza 55,5mm

Larghezza 140mm

Lunghezza 3000mm

Spessore 24 mm

PREZZO ML: 19,20 €



LISTELLO DI SUPPORTO

COD: LDS-GA

Altezza 30mm

Larghezza 40mm

Lunghezza 3000mm

Mq barra: 1,33

PREZZO PZ: 18,00 €



ANGOLARE DI CHIUSURA

COD: ADC

Altezza 30mm

Larghezza 40mm

Lunghezza 3000mm

PREZZO ML: 5,10 €



CLIPS

COD: CLIPS-DECK

PREZZO PZ: 0,22 €

28 pezzi al MQ

DETERGENTI, PRIMER E COLLANTI



MYFLOOR CLEANER

LT. 1

CODICE ARTICOLO: DET-SPC

PREZZO: €/LT 23,00

DETERGENTE NEUTRO
PER PAVIMENTI

Ad elevato potere sgrassante, consente di ottenere ottimi risultati su tutti i tipi di sporco. Adatto a tutte le superfici, anche quelle molto trafficate.



MAKE-UP / MAKE-UP MATT

LT. 1

CODICE ARTICOLO: EC22 (LUC)

CODICE ARTICOLO: EC21(MATT)

PREZZO: €/LT 43,00

PROTETTIVO RIGENERANTE PER PAVIMENTI

Esalta il colore e la profondità del disegno sui pavimenti nuovi, ripristina l'aspetto originale dei pavimenti usurati. Forma un film protettivo idrorepellente resistente al calpestio e migliora la lavabilità della superficie. Disponibile opaco e lucido.



LVT WALL

KG. 5

CODICE ARTICOLO: BE16

PREZZO: €/PZ 150,00

ADESIVO SILANICO MONOCOMPONENTE
PER LVT A PARETE - MS POLIMERO

Adatto per l'installazione di LVT ed SPC a parete su superfici assorbenti e non assorbenti. Caratterizzato da un'elevata resistenza allo scorrimento, è perfetto per ambienti esposti all'acqua e al calore.



LVT LEVELLER

CODICE ARTICOLO: AA21

PREZZO KG. 5: IN FASE D'ORDINE

PREZZO KG. 15: IN FASE D'ORDINE

LISCIATURA PRONTA ALL'USO PER FUGHE

Da utilizzare per la rasatura a zero delle fughe prima della posa incollata o flottante di LVT su pavimentazioni preesistenti. Facile da carteggiare, consente di livellare fino a 2 mm. Aggrappa perfettamente e consente di posare dopo sole 2 ore.



IDROBLOK 2K

2 X LT. 5

CODICE ARTICOLO: AB36

PREZZO: IN FASE D'ORDINE

PRIMER EPOSSIDICO BICOMPONENTE
ALL'ACQUA CONSOLIDANTE E
IMPERMEABILIZZANTE | SENZA SOLVENTI

Consolida e impermeabilizza sottofondi con umidità residua elevata (U.R. max 5%). Inodore, senza solventi, diluibile con acqua. Adatto per isolare vecchi residui di colla. A+B tempo di apertura 60/90 minuti. Ideale anche per sovrapposizioni 5+5.