

Introduction

AH603 Linear Hall-effect sensor is small, versatile device that is operated by the magnetic field from a permanent magnet. The linear sourcing output voltage is set by the supply voltage and varies in proportion to the strength of the magnetic field. The integrated circuitry features low noise output, which makes it unnecessary to use external filtering. The sensor Interfaces with many electrical components without buffering. It includes thin film resistors to provide increased temperature stability and accuracy.

The linear Hall-effect sensor has an operating temperature range of -40 °C to 150°C, appropriate for consumer, industrial and medical environments. The sensor is available in 2 package styles, which are T092 and SOT23.

Features

- Miniature construction
- Low current consumption of 5 mA at 5 Vdc
- Voltage range of 3 Vdc to 12 Vdc
- Low noise output
- Temperature range of -40 °C to 150 °C
- Highest ESD performance up to ±4 kV
- React differently to the Antarctic and Arctic magnetic fields

Potential Applications

- Current sensing
- Motor control
- Position sensing
- Magnetic code reading
- Rotary encoder
- Ferrous metal detector
- Liquid level sensing
- Weight sensing

Package

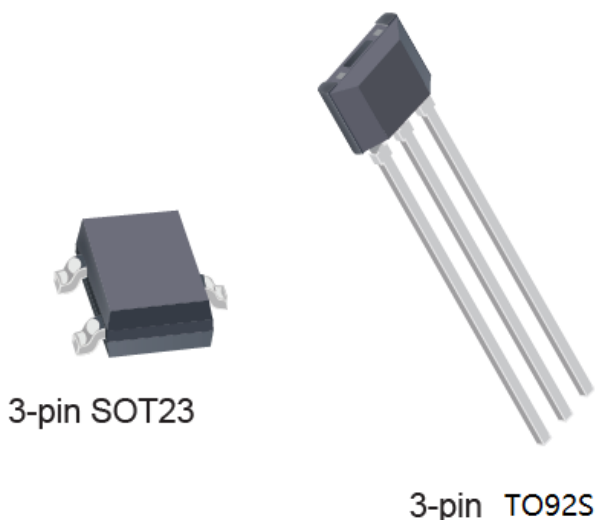

Ordering information

Part number	Package	Packing	Ambient, T _A
AH603UA	TO92	Bulk, 1000 pieces/bag	-40°C to 150°C
AH603SU	SOT23	Tape&Reel, 3000 pieces/reel	-40°C to 150°C

Pin assignment

Pin number	Name	Function
1	VDD	Power supply
2	GND	Ground
3	Vout	Output

Absolute Maximum Ratings

The absolute maximum value is the limiting value when the chip is applied, above which the chip can be damaged. Although the function of the chip is not necessarily damaged when the absolute maximum value is exceeded, the reliability of the chip may be affected if the absolute maximum value is exceeded for a certain time.

Parameter	Symbol	Value	Units
Supply voltage	VDD	15	V
Reverse voltage	VDD	-0.5	V
Output Current	I _{OUT}	5	mA
Operating temperature range	T _a	-40~150	°C
Storage temperature range	T _s	-40~165	°C

Electrical and magnetic characteristics (Ta=25°C, V_{DD} =5.0V)

Parameter	Symbol	Test Conditions	Min	Typ	Max	Units
Operating voltage	V _{DD}		3	5	12	V
Supply current	I _{DD}		3	5	8	mA
Output Current	I _{OUT}				1.5	mA
Response Time	T _{rs}			3		uS
Quiescent Output Voltage	V _O	B=0	2.25	2.5	2.75	V
Sensitivity	Sen		2.95	3.25	3.55	mV/G
Min Output Voltage	V _{min}	B= -460G		1		V
Max Output Voltage	V _{max}	B= 460G		4		V
Output load resistance	R _L	ΔV _{OUT} <15mV	200			KOhm

Function diagram

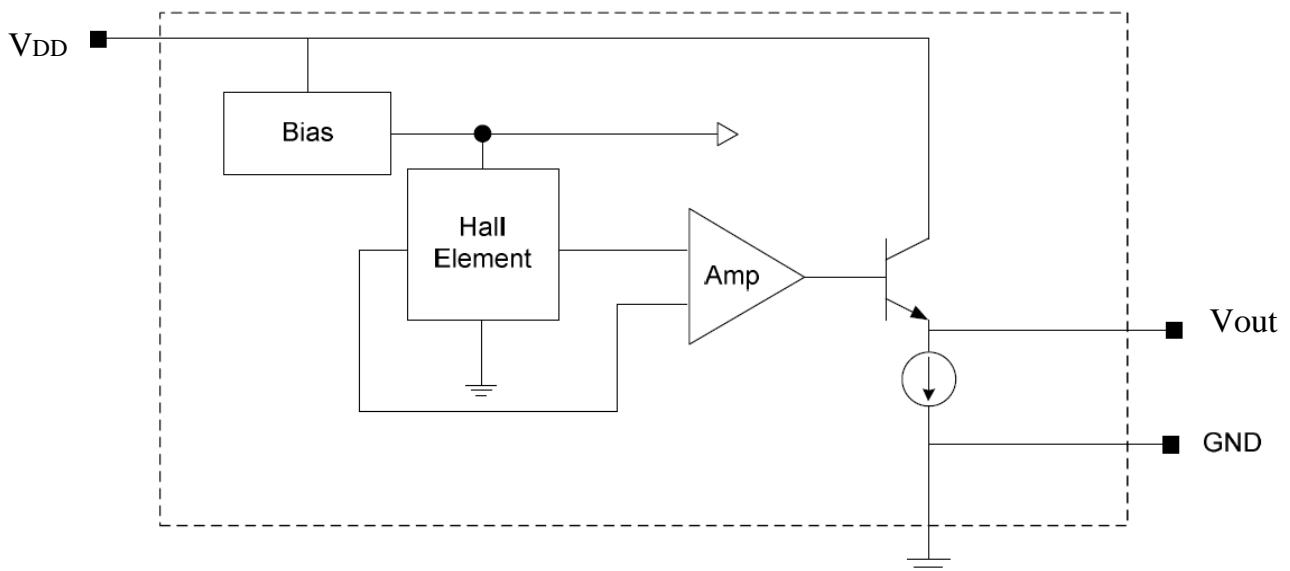

Transfer function

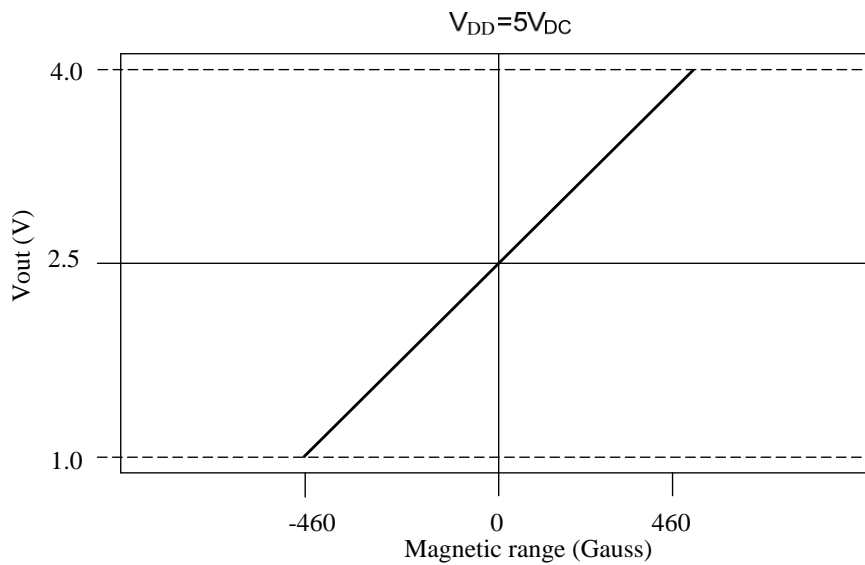

Application example: VDD =5V

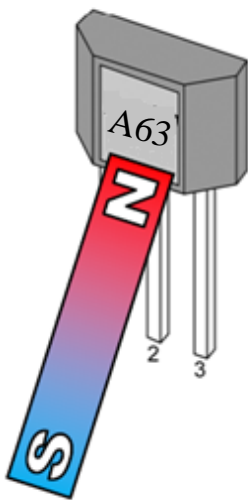

$V_{OUT} = 1.0 \text{ to } 2.5 \text{ V}$

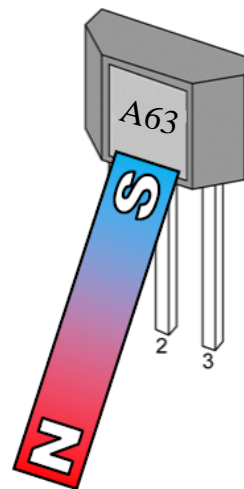

$V_{OUT} = 2.5 \text{ to } 4 \text{ V}$

TO92S (AH603UA)

TO92S Pin description

Name	Pin number	Description
VDD	1	Power supply
GND	2	Ground
Vout	3	Output

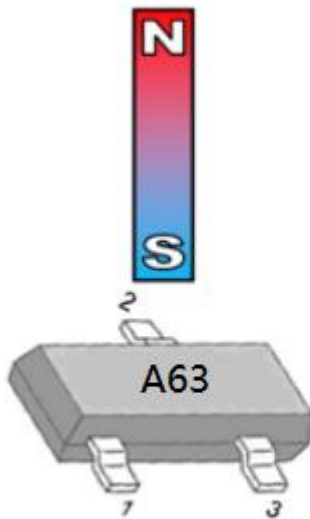

$V_{OUT} = 1.0 \text{ to } 2.5 \text{ V}$

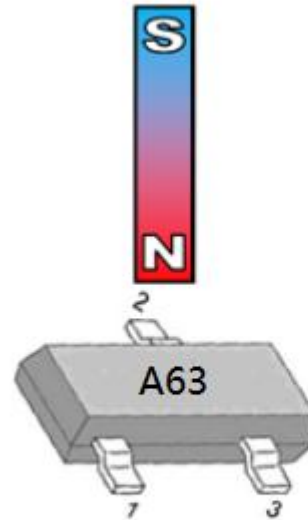

$V_{OUT} = 2.5 \text{ to } 4 \text{ V}$

SOT23 (AH603SU)

SOT23 Pin description

Name	Pin number	Description
VDD	1	Power supply
GND	2	Ground
Vout	3	Output

Typical characteristic data

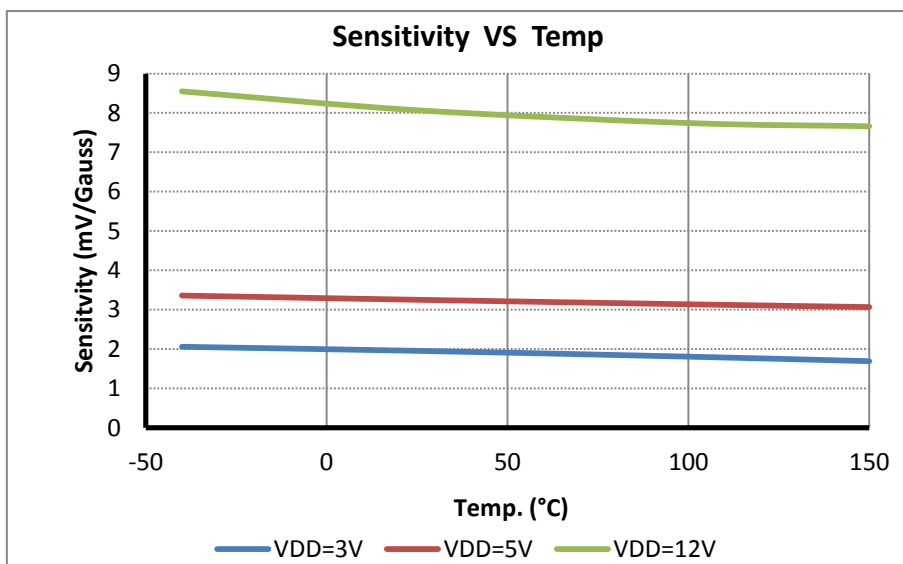
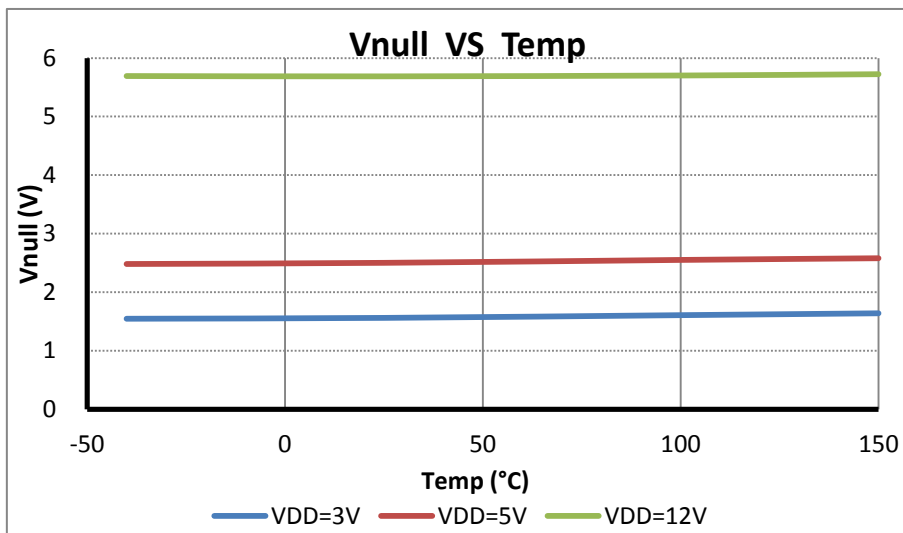
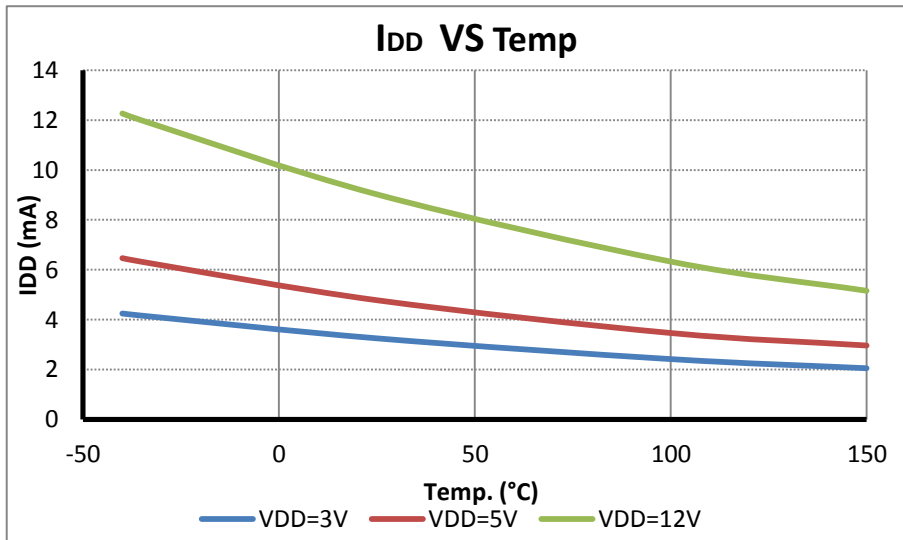

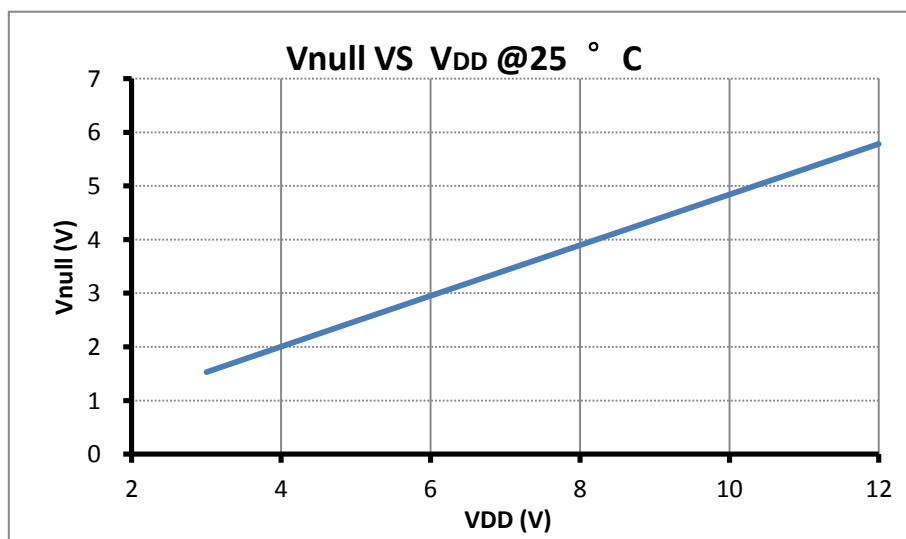
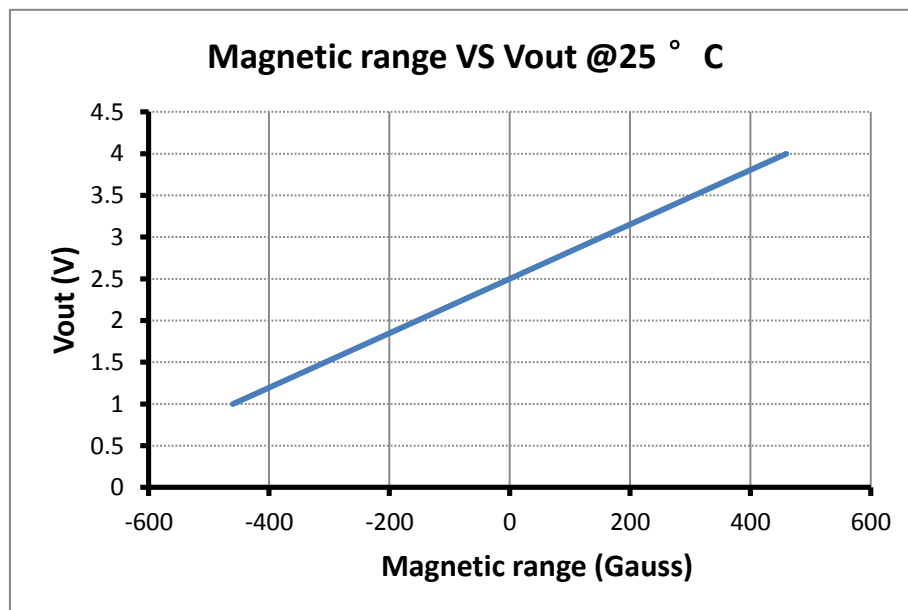
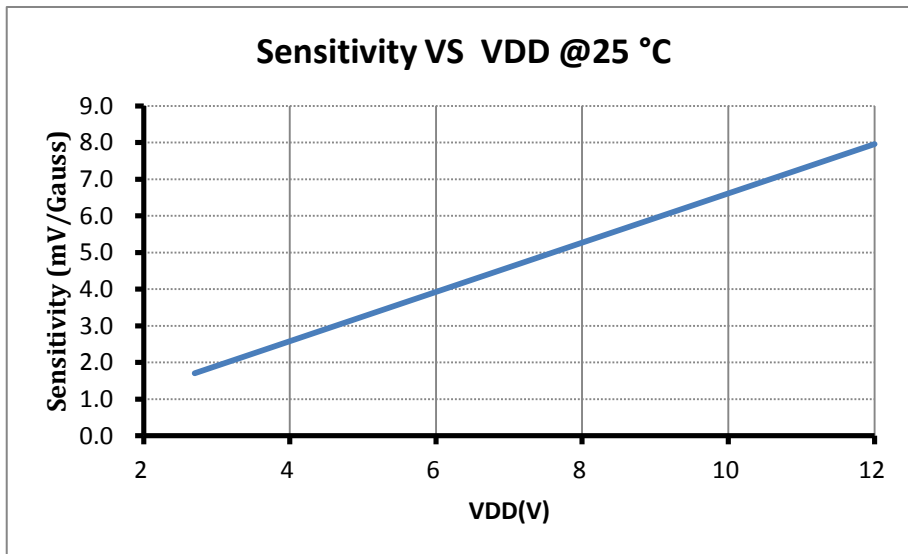

Package dimensions

T092S

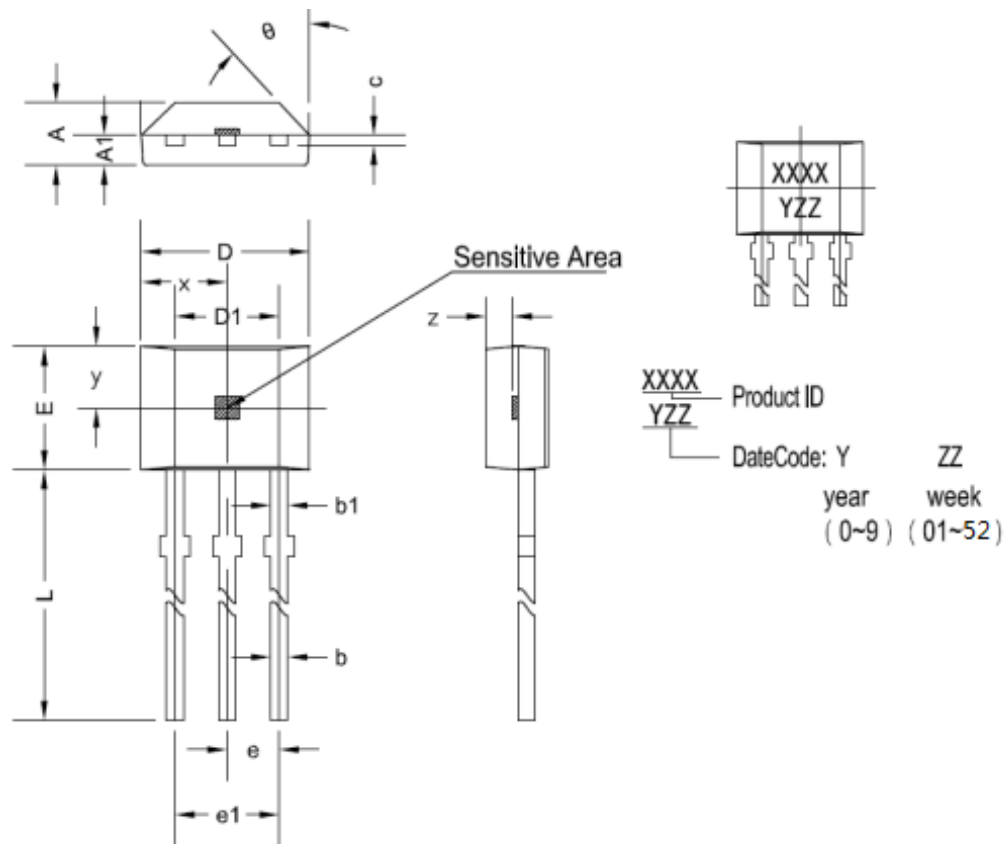

T092S dimensions

symbol	Size (mm)		Size (in inches)	
	minimum	maximum	minimum	maximum
A	1.42	1.67	0.056	0.066
A1	0.66	0.86	0.026	0.034
b	0.35	0.56	0.014	0.022
b1	0.4	0.55	0.016	0.022
C	0.36	0.51	0.014	0.02
D	3.9	4.2	0.154	0.165
D1	2.97	3.27	0.117	0.129
E	2.9	3.28	0.114	0.129
e	1.270 TYP		0.050 TYP	
e1	2.44	2.64	0.096	0.104
L	13.5	15.5	0.531	0.61
x	2.025TYP		0.080TYP	
y	1.545TYP		0.061TYP	
z	0.500TYP		0.020TYP	
θ	45°TYP		45°TYP	

SOT23

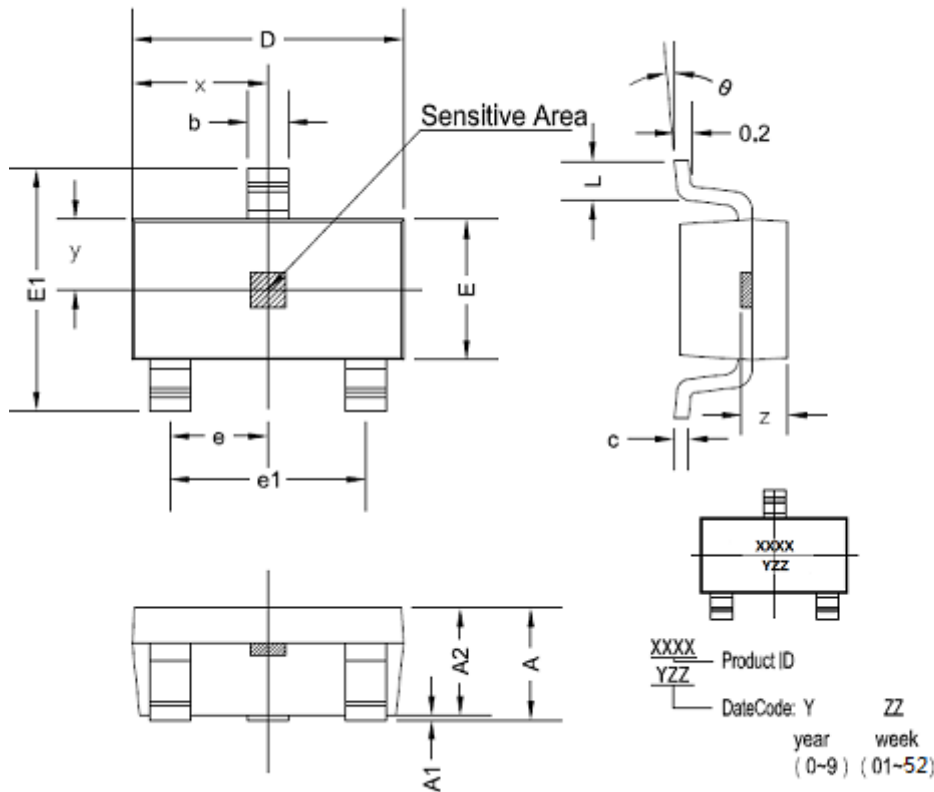

SOT23 dimensions

symbol	Size (mm)		Size (in inches)	
	minimum	maximum	minimum	maximum
A	1.05	1.25	0.041	0.049
A1	0	0.1	0	0.004
A2	1.05	1.15	0.041	0.045
b	0.3	0.5	0.012	0.02
c	0.100	0.2	0.004	0.008
D	2.82	3.02	0.111	0.119
E	1.5	1.7	0.059	0.067
E1	2.65	2.95	0.104	0.116
e	0.950 TYP		0.037 TYP	
e1	1.8	2	0.071	0.079
L	0.3	0.6	0.012	0.024
x	1.460TYP		0.057TYP	
y	0.800TYP		0.032TYP	
z	0.600TYP		0.024TYP	
θ	0°	8°	0°	8°

Typical application circuit

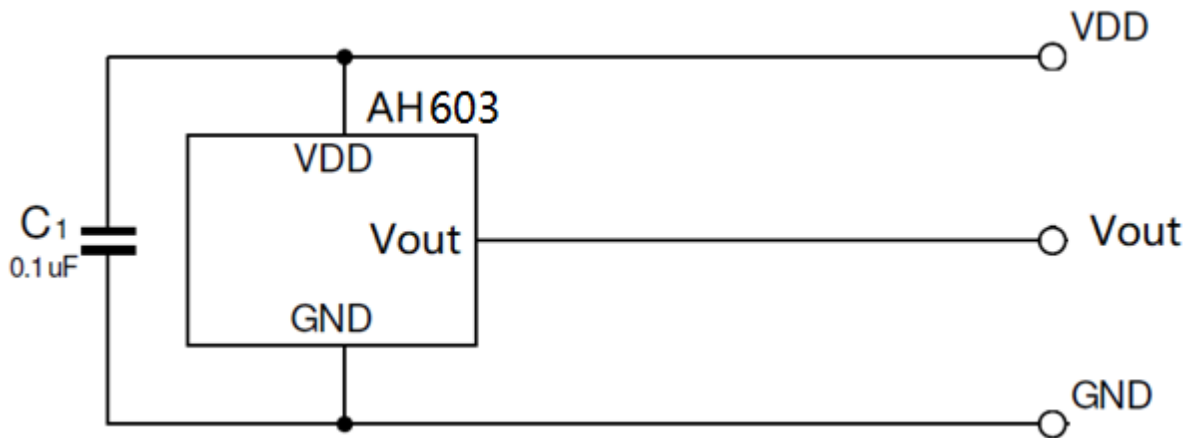

Copyright ©2018, Vinbelltech Limited

Vinbelltech Limited reserves the right to make, from time to time, such departures from the detail specifications as may be required to permit improvements in the performance, reliability, or manufacturability of its products. Before placing an order, the user is cautioned to verify that the information being relied upon is current.

Vinbelltech Limited products are not to be used in any devices or systems, including but not limited to life support devices or systems, in which a failure of Vinbelltech Limited product can reasonably be expected to cause bodily harm.

The information included herein is believed to be accurate and reliable. However, Vinbelltech Limited assumes no responsibility for its use; nor for any infringement of patents or other rights of third parties which may result from its use.