

### Introduction

The AH693, AH694, AH695 and AH696 are high performance linear Hall-Effect sensors and are operated by the magnetic field from a permanent magnet or an electromagnet. The ratiometric output voltage is set by the supply voltage and varies in proportion to the strength of the magnetic. The quiescent output voltage of the AH693, AH694, AH695, AH696 is 50% of the supply voltage, and the sensitivity is 3mV/Gauss, 3.75mV/ Gauss, 6mV/ Gauss and 12mV/ Gauss respectively.

Each sensor has a monolithic circuit which integrates a Hall element, improved temperature compensating circuitry to reduce the intrinsic sensitivity drift of the Hall element, a small-signal high-gain amplifier, and a rail-to-rail low-impedance output stage.

The features of these devices make them ideal for use in automotive and industrial applications requiring high accuracy, and are guaranteed through an extended temperature range, -40°C to 125°C.

These devices are available in a 3-pin T092S package and SOT89. Both packages are lead(Pb) free, with 100% matte tin leadframe plating.

The AH69X family provides a variety of packages to customers: flat T092S for through-hole mount and SOT89 for surface mount. All packages are RoHS compliant.

### Features

- Low-noise output with enhanced accuracy
- Ratiometric rail-to-rail output
- 4.5 to 10.5V supply voltage range
- High operation frequency
- Output voltage proportional to magnetic flux density
- Highest ESD performance up to ±4 kV
- -40°C to 125°C wide temperature range
- Fast power-on time
- Precise recoverability after temp. cycling
- 3-pin SIP and SOT89 package are available
- RoHS Compliant
- 2011/65/EU

### Applications

- Angular position
- Displacement sensing
- Over current detection
- BLDC motor current monitoring
- Weight and liquid level sensing

### Package



T092S

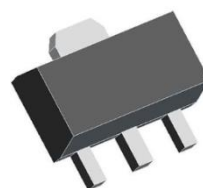

SOT89

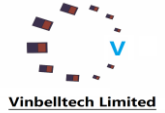

### Family Members

Part number	Package	Packing	Sensitivity
AH693	T092S/SOT89	Bag: 1k; Tape&reel: 3K	3.0 mV/Gauss
AH694	T092S/SOT89	Bag: 1k; Tape&reel: 3K	3.75 mV/Gauss
AH695	T092S/SOT89	Bag: 1k; Tape&reel: 3K	6.0 mV/Gauss
AH696	T092S/SOT89	Bag: 1k; Tape&reel: 3K	12 mV/Gauss

### Absolute Maximum Ratings

The absolute maximum value is the limiting value when the chip is applied, above which the chip can be damaged. Although the function of the chip is not necessarily damaged when the absolute maximum value is exceeded, the reliability of the chip may be affected if the absolute maximum value is exceeded for a certain time.

Parameters	Symbol	Value	Units
Supply voltage	VCC	11	V
Reverse voltage	VCC	-0.5	V
Output Sink Current	Isink	10	mA
Output Voltage	Vout	11	V
Operating temperature range	Ta	-40~125	°C
Storage temperature range	Ts	-40~165	°C

Electronic characteristic for the sensors (Vcc = 5.00V with 4.7 k output to minus, TA = -40°C to 125°C)

Symbol	Parameter	Test Condition	Min	Type	Max	Units
Icc	Supply Current	Ta=25°C	-	4.5	7	mA
Is	Output Current	Vcc>4.5V	1.0	1.5	-	mA
trs	Response time		-	3	-	µs
VOM	Output voltage swing VOM- VOM+	-B applied +B applied	0.4 Vcc-0.4	0.2 Vcc- 0.3	-	V
Vcc	Supply voltage	TA = -40°C to 125°C	4.5	5.0	10.5	V
Top	Operating temperature		-40		125	° c
Temp Sol	Soldering temperature and time	Wave soldering process : 250 ° c to 260° c for 3s max Infrared reflow process : 245 ° c for 10s max				

Magnetic characteristic for AH693 ( $V_{cc} = 5.00V$  with 4.7 kohms output to minus,  $T_A = -40^{\circ}C$  to  $125^{\circ}C$ )

Symbol	Parameter	Test Condition	Min	Type	Max	Units
Br	B limits for linear operation	-B max	-650	-700	-	Gauss
		+B max	650	700	-	
Lin	Linearity	B=-650 to +650	-1.5	0	1.5	% of Span
AH693A						
Sens	Sensitivity	$T_A = 25^{\circ}C$	2.88	3	3.12	mV/Gauss
VoutQ	Quiescent Voltage	$T_A = 25^{\circ}C$	2.425	2.5	2.575	V
Sens(T)	Sensitivity Drift	$T_A = -40$ to $25^{\circ}C$ ;	-0.06		0.02	%/ $^{\circ}C$
		$T_A = 25$ to $125^{\circ}C$ ;	-0.06		0.02	%/ $^{\circ}C$
VoutQ (T)	VoutQ drift	$T_A = -40$ to $25^{\circ}C$ ;	-0.04		0	%/ $^{\circ}C$
		$T_A = 25$ to $125^{\circ}C$ ;	-0.04		0	%/ $^{\circ}C$
AH693B						
Sens	Sensitivity	$T_A = 25^{\circ}C$	2.78	3	3.24	mV/Gauss
VoutQ	Quiescent Voltage	$T_A = 25^{\circ}C$	2.35	2.5	2.65	V
Sens(T)	Sensitivity Drift	$T_A = -40$ to $25^{\circ}C$ ;	-0.08		0.03	%/ $^{\circ}C$
		$T_A = 25$ to $150^{\circ}C$ ;	-0.08		0.03	%/ $^{\circ}C$
VoutQ (T)	VoutQ drift	$T_A = -40$ to $25^{\circ}C$ ;	-0.06		0	%/ $^{\circ}C$
		$T_A = 25$ to $125^{\circ}C$ ;	-0.06		0	%/ $^{\circ}C$

Magnetic characteristic for AH694 ( $V_{cc} = 5.00V$  with 4.7 kohms output to minus,  $T_A = -40^{\circ}C$  to  $125^{\circ}C$ )

Symbol	Parameter	Test Condition	Min	Type	Max	Units
Br	B limits for linear operation	-B max	-500	-560	-	Gauss
		+B max	500	560	-	

# AH69X series

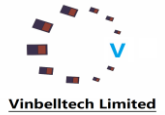

## High Voltage Hall Effect Switch Sensor Vinbelltech Limited

Lin	Linearity	B=-650 to +650	-1.5	0	1.5	% of Span
AH694A						
Sens	Sensitivity	TA=25°C	3.63	3.75	3.87	mV/Gauss
VoutQ	Quiescent Voltage	TA=25°C	2.425	2.5	2.575	V
Sens(T)	Sensitivity Drift	TA=-40 to 25°C;	-0.04		0.03	%/°C
		TA=25 to 125°C;	-0.05		0.04	%/°C
VoutQ (T)	VoutQ drift	TA=-40 to 25°C;	-0.02	-0.01	0	%/°C
		TA=25 to 125°C;	-0.04	-0.01	0	%/°C
AH694B						
Sens	Sensitivity	TA=25°C	3.5	3.75	4	mV/Gauss
VoutQ	Quiescent Voltage	TA=25°C	2.32	2.5	2.68	V
Sens(T)	Sensitivity Drift	TA=-40 to 25°C;	-0.07		0.04	%/°C
		TA=25 to 125°C;	-0.08		0.05	%/°C
VoutQ (T)	VoutQ drift	TA=-40 to 25°C;	-0.03		0.01	%/°C
		TA=25 to 125°C;	-0.05		0	%/°C

Magnetic characteristic for AH695 (Vcc= 5.00V with 4.7 kohms output to minus, TA = -40° C to 125° C)

Symbol	Parameter	Test Condition	Min	Type	Max	Units
Br	B limits for linear operation	-B max	-300	-320	-	Gauss
		+B max	300	320	-	
Lin	Linearity	B=-320 to +320	-1.5	0	1.5	% of Span
AH695A						
Sens	Sensitivity	TA=25°C	5.85	6	6.15	mV/Gauss
VoutQ	Quiescent Voltage	TA=25°C	2.425	2.5	2.575	V
Sens(T)	Sensitivity Drift	TA=-40 to 25°C;	-0.06		0.02	%/°C

		TA=25 to 125°C;	-0.06		0.02	%/°C
VoutQ (T)	VoutQ drift	TA=-40 to 25°C;	-0.04		0	%/°C
		TA=25 to 125°C;	-0.04		0	%/°C
<b>AH695B</b>						
Sens	Sensitivity	TA=25°C	5.7	6	6.3	mV/Gauss
VoutQ	Quiescent Voltage	TA=25°C	2.35	2.5	2.65	V
Sens(T)	Sensitivity Drift	TA=-40 to 25°C;	-0.09		0.03	%/°C
		TA=25 to 125°C;	-0.09		0.03	%/°C
VoutQ (T)	VoutQ drift	TA=-40 to 25°C;	-0.06		0	%/°C
		TA=25 to 125°C;	-0.06		0	%/°C

Magnetic characteristic for AH696 (Vcc= 5.00V with 4.7 k output to minus, TA = -40° C to 125° C)

Symbol	Parameter	Test Condition	Min	Type	Max	Units
Br	B limits for linear operation	-B max	-125	-175	-	Gauss
		+B max	125	175	-	
Lin	Linearity	B=-175 to +175	-1.5	0	1.5	% of Span
<b>AH696A</b>						
Sens	Sensitivity	TA=25°C	11.7	12	12.3	mV/Gauss
VoutQ	Quiescent Voltage	TA=25°C	2.4	2.5	2.6	V
Sens(T)	Sensitivity Drift	TA=-40 to 25°C;	-0.06		0.02	%/°C
		TA=25 to 125°C;	-0.06		0.02	%/°C
VoutQ (T)	VoutQ drift	TA=-40 to 25°C;	-0.04		0	%/°C
		TA=25 to 125°C;	-0.04		0	%/°C
<b>AH696B</b>						
Sens	Sensitivity	TA=25°C	11.4	12	12.6	mV/Gauss

VoutQ	Quiescent Voltage	TA=25°C	2.32	2.5	2.68	V
Sens(T)	Sensitivity Drift	TA=-40 to 25°C;	-0.09		0.03	%/°C
		TA=25 to 125°C;	-0.09		0.03	%/°C
VoutQ (T)	VoutQ drift	TA=-40 to 25°C;	-0.06		0	%/°C
		TA=25 to 125°C;	-0.06		0	%/°C

## Function diagram

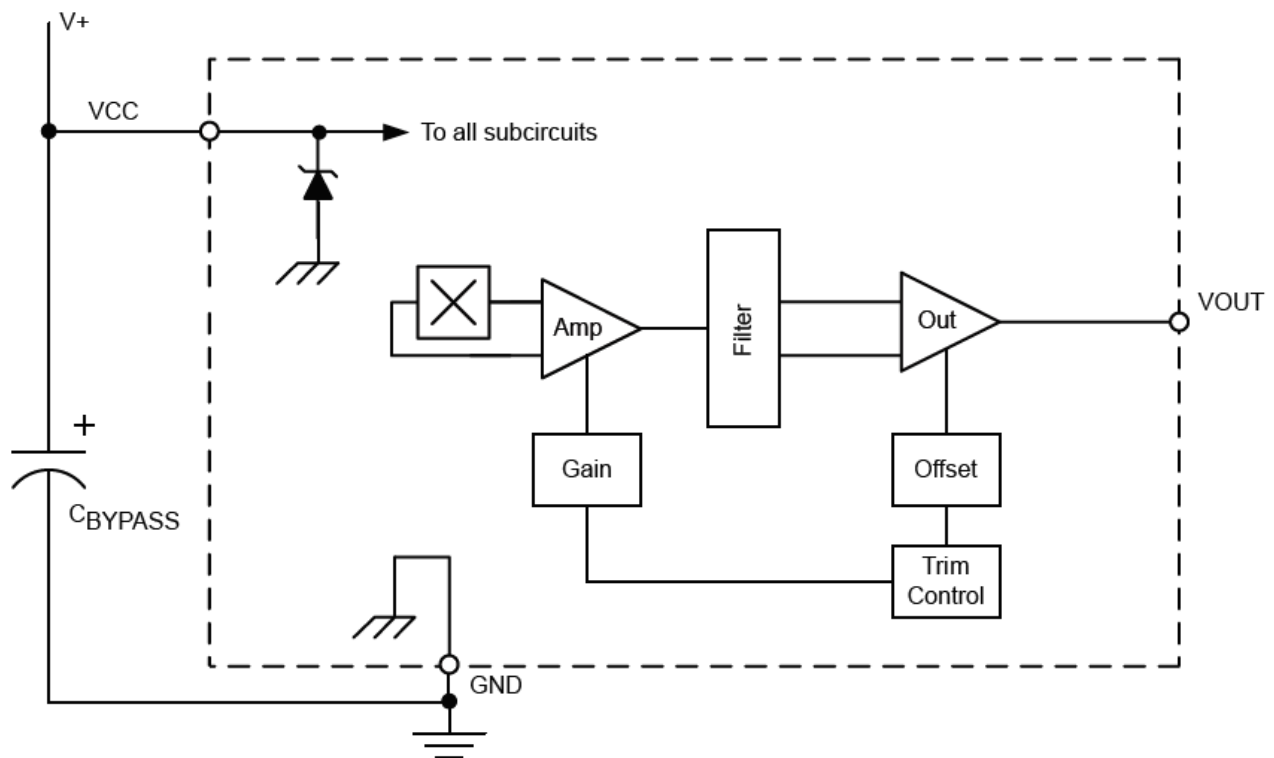

### Pin orientation

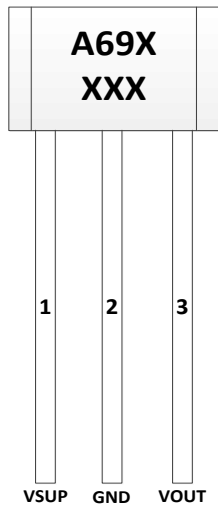

T092S

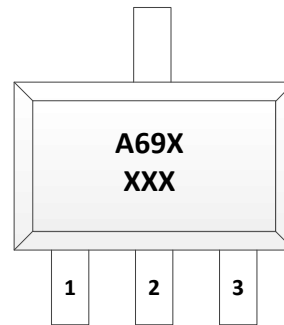

SOT89

### Pin description

Symbol	Number		Description
	Package SOT89	Package T092S	
VCC	1	1	Connects power supply to chip
Vout	2	3	Output from sensor
GND	3	2	Ground

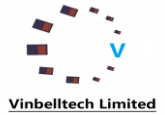

### CHARACTERISTIC DEFINITIONS

**Quiescent Voltage Output** In the quiescent state (that is, with no significant magnetic field:  $B = 0$ ), the output,  $V_{OUT}(Q)$ , equals a ratio of the supply voltage,  $V_{CC}$ , throughout the entire operating range of  $V_{CC}$  and the ambient temperature,  $T_A$ .

**Quiescent Voltage Output Drift Through Temperature** Due to internal component tolerances and thermal considerations, the quiescent voltage output,  $V_{OUTQ}$  may drift from its nominal value through the operating ambient temperature range  $T_A$ . For purposes of specification, the Quiescent Voltage Output Drift Through Temperature Range,  $V_{outQ}$  drift (T) is defined as:

$$V_{outQ} \text{ drift (T)} = (V_{OUTQ}(T) - V_{OUTQ}(25^\circ\text{C})) / V_{OUTQ}(25^\circ\text{C}) \times 1 / (T - 25^\circ\text{C}) \times 100\% \quad (1)$$

**Sensitivity** The presence of a south-polarity magnetic field perpendicular to the branded surface of the package increases the output voltage from its quiescent value toward the supply voltage rail. The amount of the output voltage increase is proportional to the magnitude of the magnetic field applied. Conversely, the application of a north polarity field will decrease the output from its quiescent value. This proportionality is specified as the magnetic sensitivity,  $Sens$  (mV/G), of the device and is defined as:

$$Sens = (V_{OUT}(B+) - V_{OUT}(B-)) / (B(+) - B(-)) \quad (2)$$

where  $B(+)$  and  $B(-)$  are two magnetic fields with opposite polarities.

**Sensitivity Drift Through Temperature** The device sensitivity changes with temperature, with respect to its sensitivity temperature coefficient. Sensitivity Drift (T) may drift from its nominal value through the operating ambient temperature range  $T_A$ . For purposes of specification, the Sensitivity Drift Through Temperature, Sensitivity Drift (T) is defined as:

$$Sensitivity \text{ Drift (T)} = (Sensitivity(T) - Sensitivity(25^\circ\text{C})) / Sensitivity(25^\circ\text{C}) \times 1 / (T - 25^\circ\text{C}) \times 100\% \quad (3)$$



### Typical Characteristics

Average output versus Magnetic flux

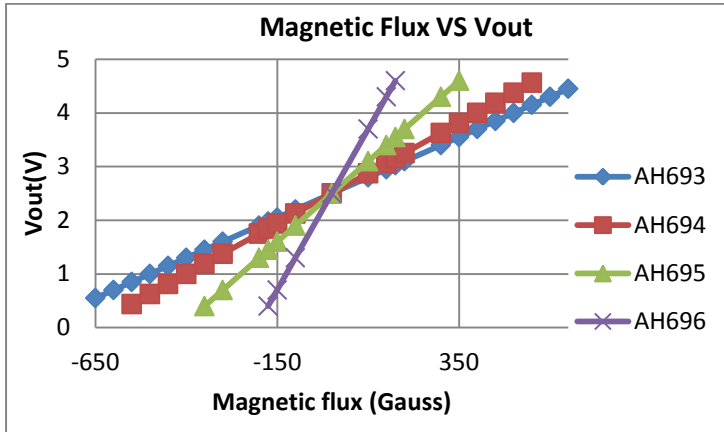

Average Supply Current versus Ambient Temperature

VCC = 5 V ( AH693/ AH694/ AH695/ AH696 )

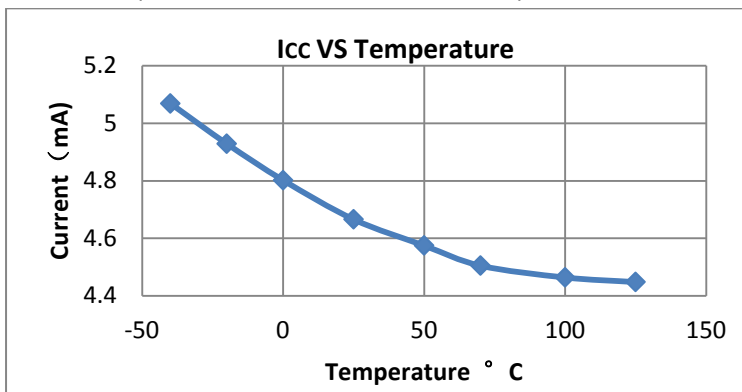

Average Absolute Quiescent Voltage Output versus Ambient Temperature

VCC = 5 V

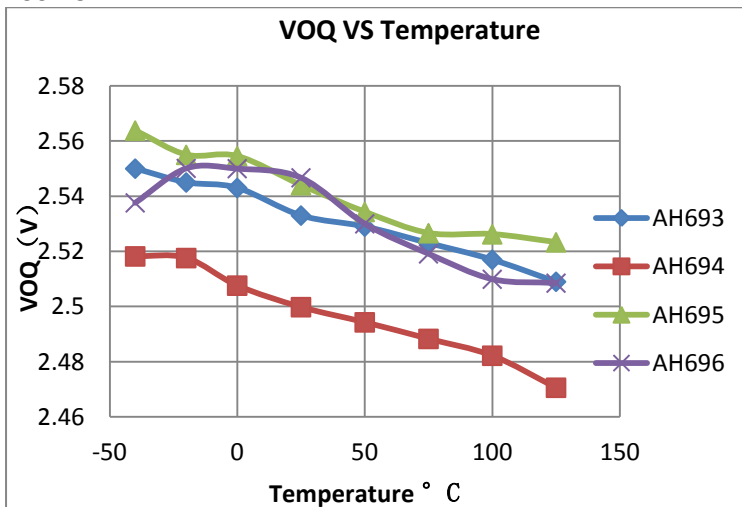

Average Sensitivity versus Ambient Temperature  
VCC = 5 V

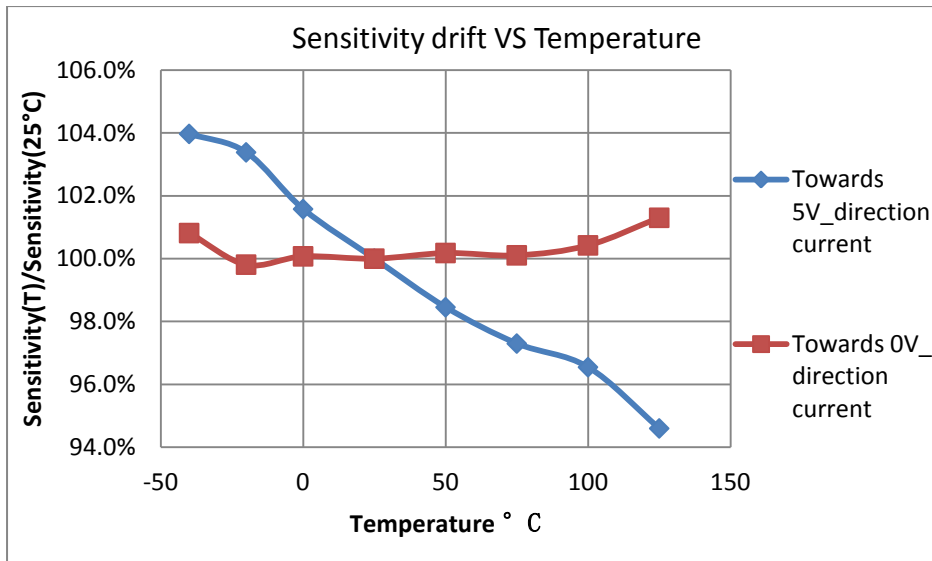

### Typical Application Circuit

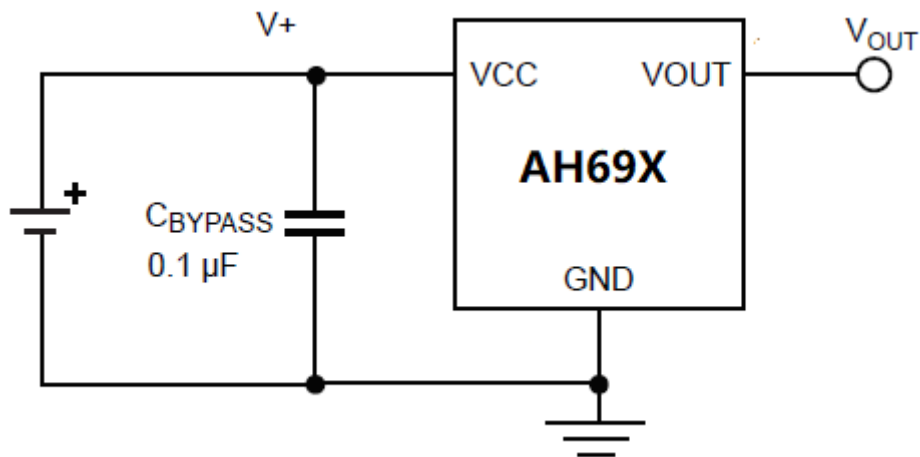

### Package dimensions

#### T092S

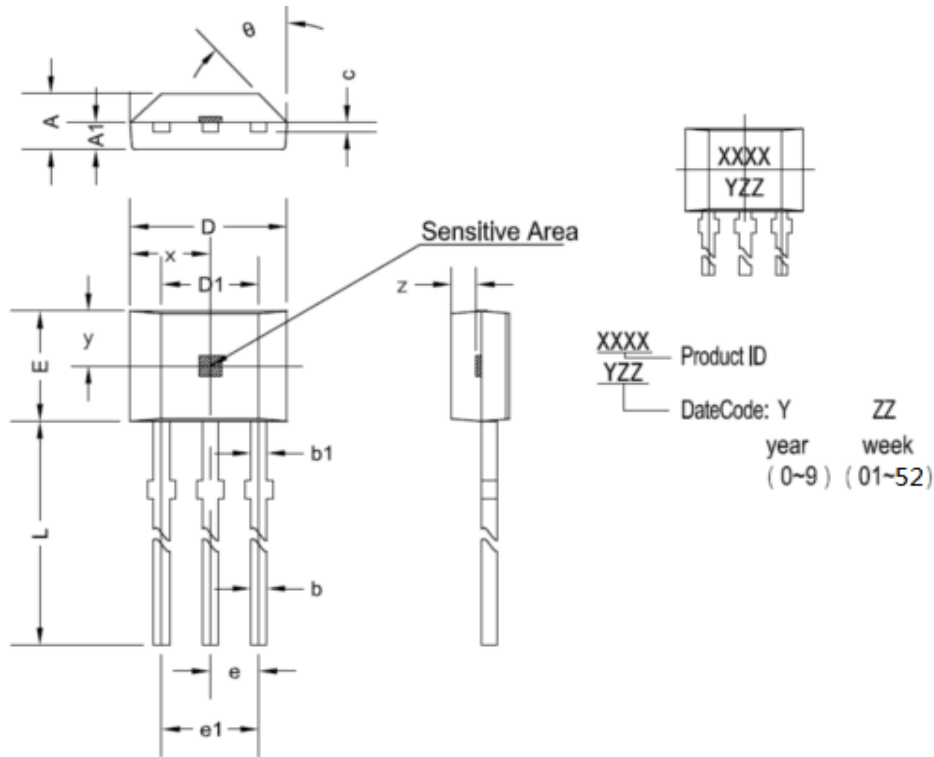

### T092S dimensions

symbol	Size (mm)		Size (in inches)	
	minimum	maximum	minimum	maximum
A	1.420	1.666	0.056	0.065
A1	0.660	0.860	0.026	0.034
b	0.350	0.560	0.014	0.022
b1	0.400	0.550	0.016	0.022
C	0.360	0.510	0.014	0.02
D	3.900	4.200	0.154	0.165
D1	2.970	3.270	0.117	0.129
E	2.900	3.280	0.114	0.129
e	1.270 TYP		0.050 TYP	
e1	2.44	2.64	0.096	0.104
L	13.5	15.5	0.531	0.61
x	2.025TYP		0.080TYP	
y	1.545TYP		0.061TYP	
z	0.500TYP		0.020TYP	
θ	45°TYP		45°TYP	

### SOT89

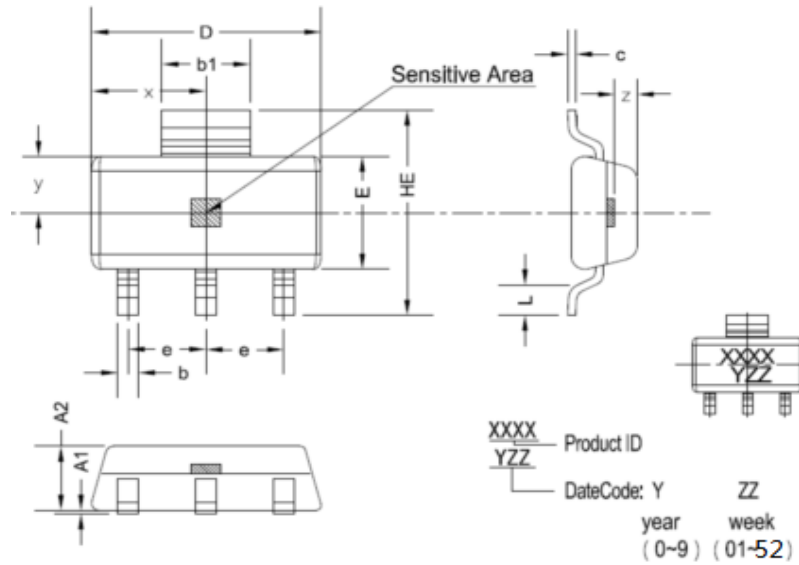

### SOT89 dimensions

符号	尺寸 (毫米)		尺寸 (英尺)	
	最小	最大	最小	最大
A	1.450	1.750	0.057	0.069
A1	0.100	0.250	0.004	0.010
A2	1.350	1.550	0.053	0.061
b	0.330	0.510	0.013	0.020
c	0.170	0.250	0.007	0.010
D	4.700	5.100	0.185	0.201
E	5.800	6.200	0.228	0.244
E1	3.800	4.000	0.150	0.157
e	1.270(BSC)		0.050(BSC)	
L	0.400	1.270	0.016	0.050
$\theta$	0°	8°	0°	8°

Copyright ©2018, Vinbelltech Limited

Vinbelltech Limited reserves the right to make, from time to time, such departures from the detail specifications as may be required to permit improvements in the performance, reliability, or manufacturability of its products. Before placing an order, the user is cautioned to verify that the information being relied upon is current.

Vinbelltech Limited products are not to be used in any devices or systems, including but not limited to life support devices or systems, in which a failure of Vinbelltech Limited product can reasonably be expected to cause bodily harm.

The information included herein is believed to be accurate and reliable. However, Vinbelltech Limited assumes no responsibility for its use; nor for any infringement of patents or other rights of third parties which may result from its use.