

Extra Wide for EV Vehicles & Special Applications.



Introducing our new wide jacking
beam ideal for electric vehicles



AC HYDRAULIC
NO COMPROMISE

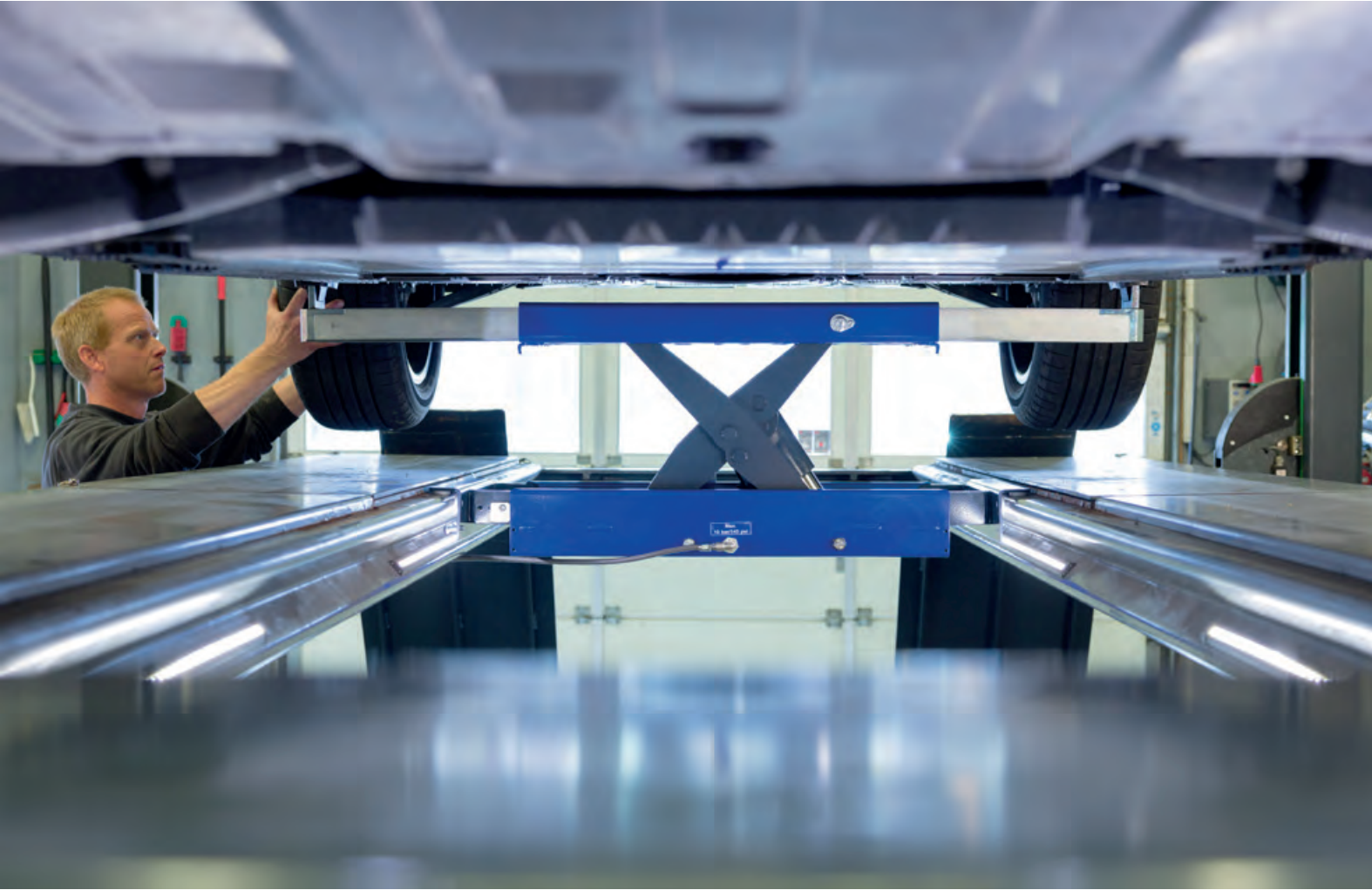

See all accessories at
www.achydraulic.com





RAISING THE STANDARD

The modern vehicle is getting wider and wider still, accommodating the user's demand for comfortability and space whilst driving. Meanwhile, electric cars are becoming more popular, and the presence of batteries is slowly changing the needs of the workshop.

As a response, we introduce the new SD26PHL wide edition jacking beam with a width of up to 1865mm. It easily reaches lifting points outside of any battery frame, ensuring that electric cars can be lifted without damaging the battery pack. Similarly, it meets the demand of modern, wide-based SUVs, stationcars and sedans.

KEY FEATURES

- Flexible top support beam can be extended up to 1865 mm
- Closed height of only 190mm optimal for vehicles with a low clearance
- Quick and reliable lifting due to the faster and more efficient pump
- Unique height adjustable mounting bracket system to fit any lift
- Two-hand lowering operation with dead man's release
- Supplied with 3 extension sets (10/40/85 mm) and rubber cushion

ONLY JACKING BEAM ON THE MARKET WITH 1865 MM WIDTH

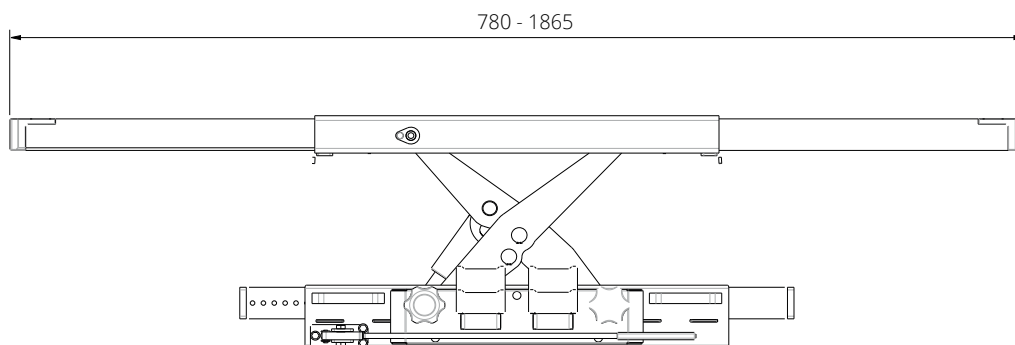

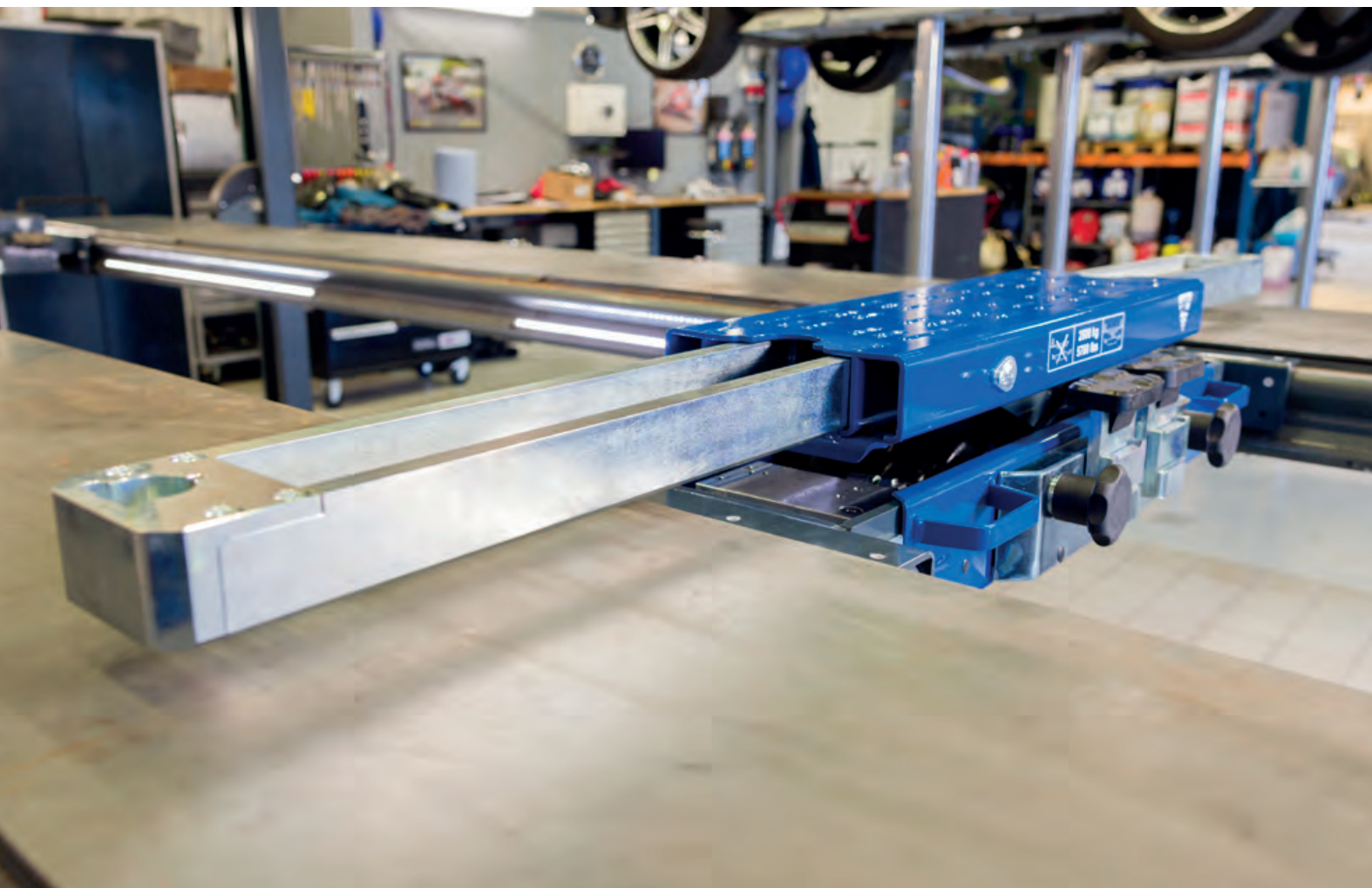

Packed in a neat steel casing, the new and radically improved pump ensures more efficiency and reliability

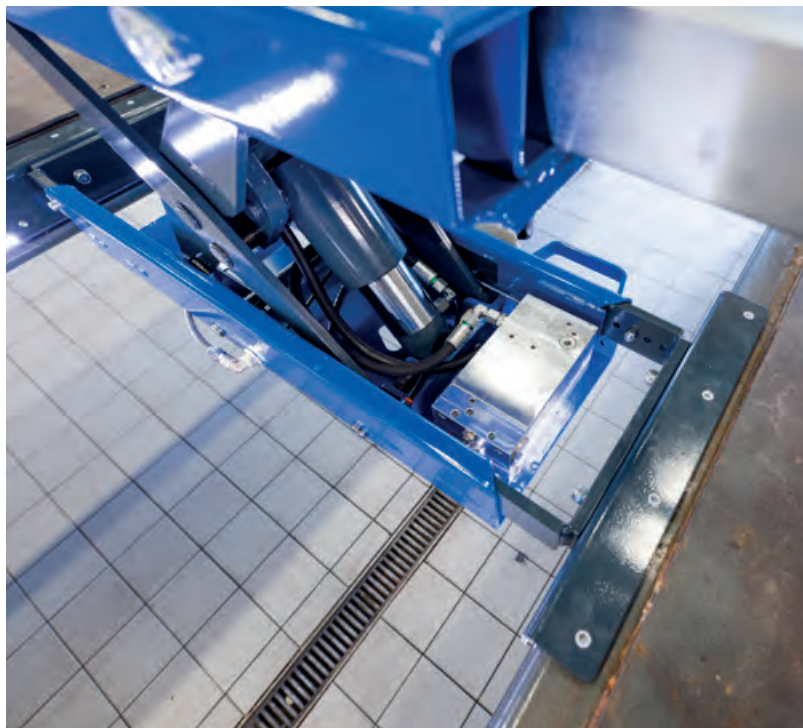



RELIABLE AS EVER

The new wide jacking beam of course comes with all the popular benefits of the AC Hydraulic jacking beam program. It features a closed height of only 190mm optimized for low clearance vehicles, automatic safety locking device, and overload valve for optimum safety. In addition, it comes with two-hand lowering operation with dead man's release, as well as quick and reliable lifting due to the faster and more efficient pump.

New pump

The wide edition features our new and improved pump, which ensures even more reliability, as well as over 50% faster lifting.

Flexible mounting bracket system

Like any AC Hydraulic jacking beam, the new wide edition features our unique height adjustable mounting bracket system, which ensures a perfect fit on any lift - no matter the manufacturer.



TECHNICAL DATA

Capacity	2600 kg
Stroke	250 mm
Min. Height	190 mm
Lifting arms	780 - 1865 mm
Width (without mounting brackets)	780 - 1180 mm
Lifting frame height	120 mm
Lifting frame depth	250 mm
Air supply	8 - 10 bar
Air consumption	400 - 700 l/min
Weight (without mounting brackets)	120 kg

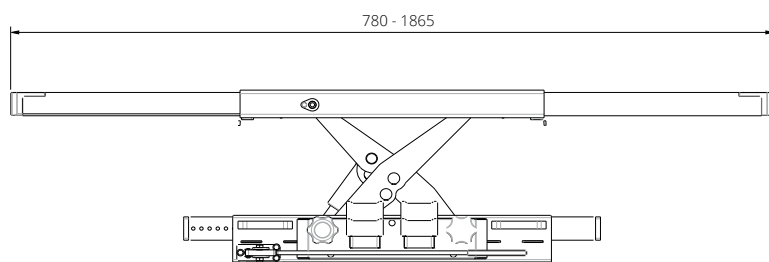
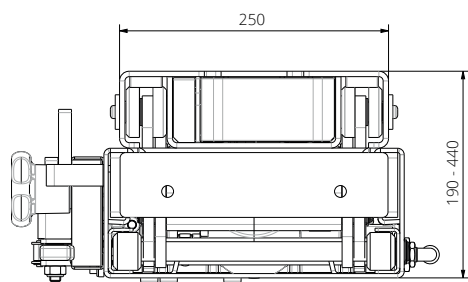

ACCESSORIES



GS1
Rubber cushion



HSD
Air-line connection

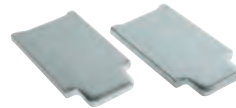

FSD1
Extension



FSD2
Rubber support



FSD3
Rubber support



FSD4
Extension



FSD5
Saddle with spindle



FSD6
Adjustable saddle



FSD7
Extension



GS2
Rubber cushion



10 YEAR
3 YEAR UNLIMITED
WARRANTY
MADE IN DENMARK 

**THE WORLD'S
LONGEST WARRANTY**

Just as our products offer high performance and quality, so does our warranty. All our products are covered by a 10 year warranty on frame, chassis, and steel structures as well as a 3 year warranty on the hydraulic system (pump and cylinder).

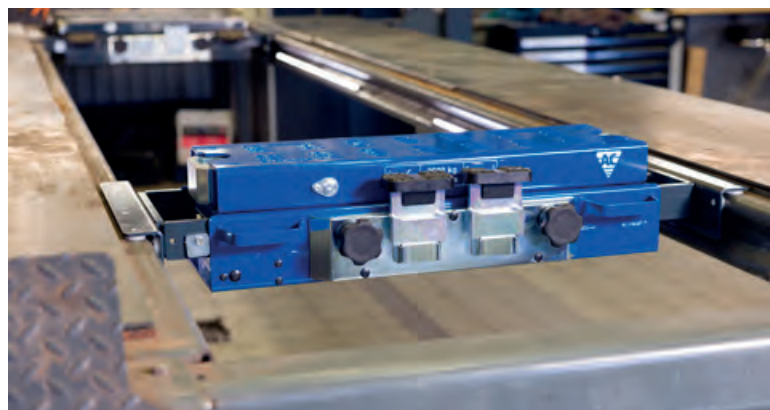

VISIT US ONLINE AT
WWW.ACHYDRAULIC.COM

Multitune GE Ltd
25 The Avenue
Wroxham
Norwich
NR12 8TR

Tel 01603 781999
www.multitune.net

AC Hydraulic A/S
Fanøvej 6 • DK-8800 Viborg • Denmark
Tel. +45 8662 2166

