

Lista de Recambios / Spare part list

Nº Ident / Ident-no 003500100

Nombre / term EGA Relax



Cliente / customer

Proyecto / project

Fecha / stand October 2013



1.- REALIZACIÓN DE UN PEDIDO/ PLACING AN ORDER

* A la hora de pedir una pieza de recambio, deberá tener en cuenta estos diferentes aspectos: /
When ordering spare parts, the following aspects should be born in mind:

1. Mano de la pieza: en el catálogo hay referencias que poseen mano (izquierda/ derecha) y para determinarla deberá sentarse en el asiento al cual va a ir destinado el recambio y ver la posición que ocupa (a la izquierda o a la derecha) respecto de Usted. Para aclararlo vea el siguiente croquis: / **Part side:** *in the catalogue some references have side indicated (left/ right), in order to determine which applies you should sit in the seat for which the part is intended and note which position it occupies (to the left or the right) with respect to yourself. The following drawing shows this:*

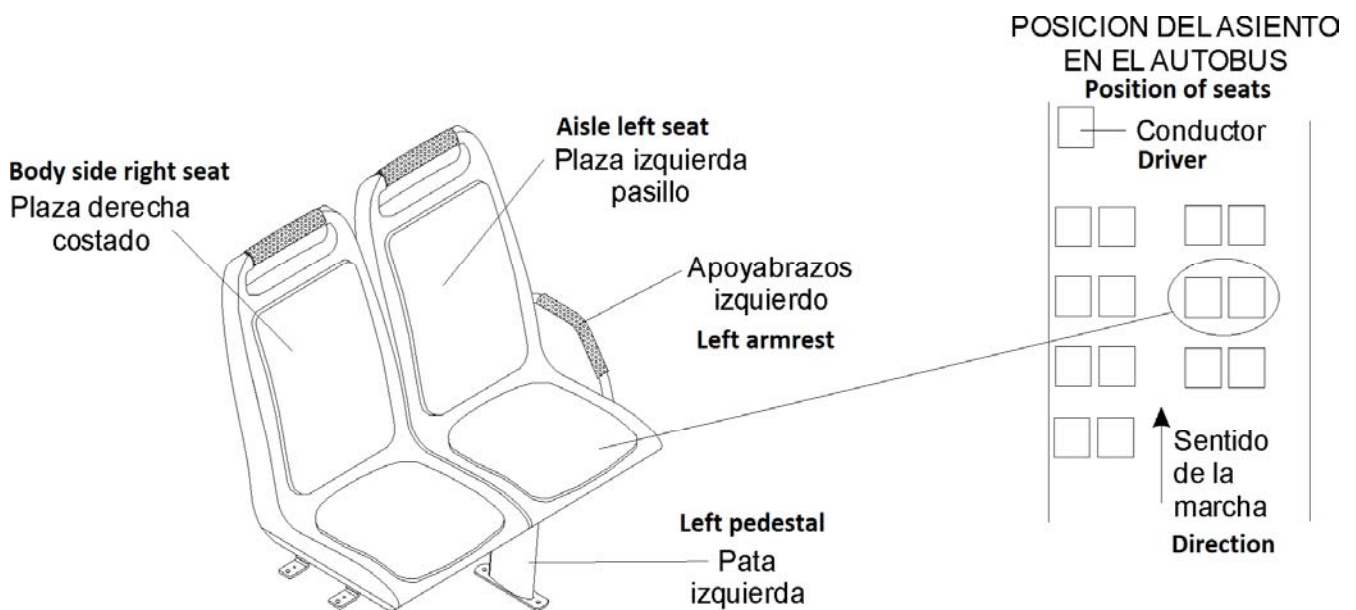

2. Color de la pieza: hay referencias que pueden tener más de un color. / *Part colour: some references may have more than one colour.*

3. Tipo de tejido: en todas aquellas piezas que tengan textil, deberá determinarlo exactamente para realizar el pedido e indicar el número de obra y la posición del asiento dentro del autocar. / *Textile type: for all parts which contain textiles, this should be exactly determined when ordering and the body number and the position of the seat within the coach indicated.*

4. Obra: si tiene cualquier duda a la hora de elegir la referencia deseada, indique el número de obra y la posición del asiento en el autocar. / *Work: if you have any doubts when choosing the desired reference, indicate the body number of the bus/coach and the position of the seat within the coach.*

Lista de Recambios / Spare part list

Nº Ident / Ident-no 003500100

Nombre / term EGA Relax









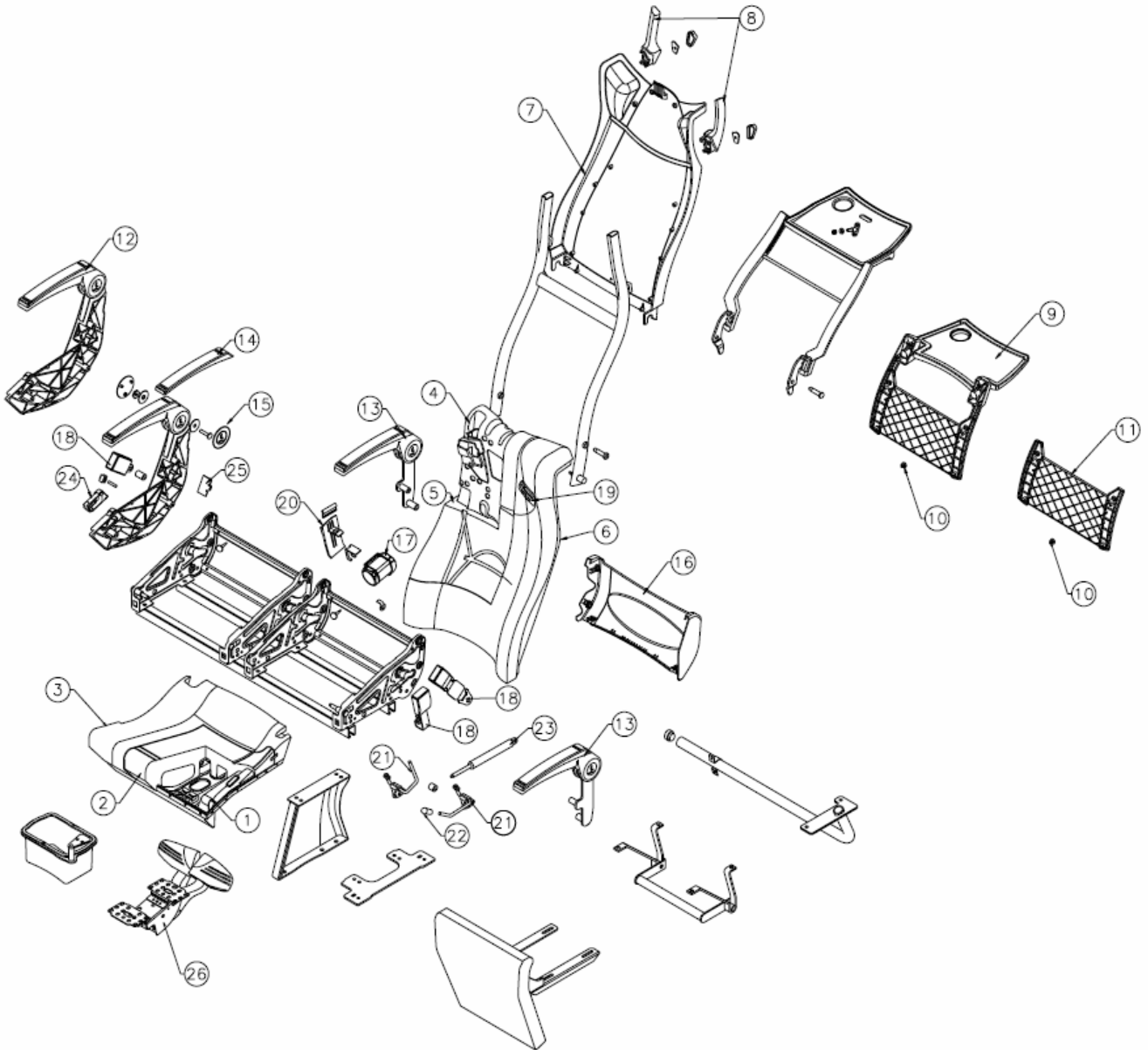





Cliente / customer











Proyecto / project











Fecha / stand October 2013















Nº	Referencia	Foto/Photo	Denominación	Description	Comentarios/Remarks
Nr	Part no.				
1	003540403-N50		Fondo cojin	Cushion pan	
2	003510401		Espuma cojin	Cushion foam	
3.1	003504400-CFG		Cojin tapizado pasillo	Aisle trimmed cushion	Facilitar nº obra y posicion / Body number and position is required
3.2	003504410-CFG		Cojin tapizado ventana	Window trimmed cushion	Facilitar nº obra y posicion / Body number and position is required
4.1	003540402-N50		Fondo respaldo	Backrest squab	
4.2	003543436-N50		Fondo respaldo asiento derecho "comfort belt"	Backrest squab for right seat "comfort belt"	Para asientos confort belt / For confort belt seat
4.3	003543437-N50		Fondo respaldo asiento izquierdo "comfort belt"	Backrest squab for left seat "comfort belt"	Para asientos confort belt / For confort belt seat
5.1	003510301		Espuma respaldo	Backrest Foam	
5.2	003511302		Espuma respaldo asiento derecho "comfort belt"	Backrest foam for right seat "comfort belt"	Para asientos confort belt / For confort belt seat
5.3	003511301		Espuma respaldo asiento izquierdo "comfort belt"	Backrest foam for left seat "comfort belt"	Para asientos confort belt / For confort belt seat
6.1	003504300-CFG		Respaldo tapizado pasillo	Aisle trimmed backrest	Facilitar nº obra y posicion / Body number and position is required
6.2	003504310-CFG		Respaldo tapizado ventana	Window trimmed backrest	Facilitar nº obra y posicion / Body number and position is required

Nº	Referencia	Foto/Photo	Denominación	Description	Comentarios/Remarks
Nr	Part no.				
7.1	003540410-G21		Carcasa de respaldo para asas sin accesorios	Backrest shell without accesories	
7.2	003507830-G21		Carcasa de respaldo para asas con revistero	Backrest shell with net magazine	
7.3	003507831-G21		Carcasa de respaldo para asas con revistero y mesita	Backrest shell with net magazine and table	
7.4	003507810-002		Carcasa de respaldo <u>portaobjetos</u> para asas sin accesorios	Storage tray backrest shell without accesories	
7.5	003507833-G21		Carcasa de respaldo <u>portaobjetos</u> para asas con revistero	Storage tray backrest shell with net magazine	
7.6	003507834-G21		Carcasa de respaldo <u>portaobjetos</u> para asas con revistero y mesita	Storage tray backrest shell with net magazine and table	
8.1	003540405G26-KIT		Asas de respaldo	Backrest handle	
8.2	003540407G26-KIT		Tapones asidero	Handle cover	El kit consta de 5 tapas izdas y 5 dchas/ Every kit has 5 left handle cover and 5 right handle cover
9	003507821-KIT		Mesita con revistero	Table and magazine net	
10	003540901-G26		Clip fijacion revistero	Magazine net clip	Lote mínimo/Minimun batch: 50 un.
11	003507301-KIT		Revistero	Magazine net	

Nº	Referencia	Foto/Photo	Denominación	Description	Comentarios/Remarks
Nr	Part no.				
12.1	003504200-CFG		Lateral izdo	Left lateral	Facilitar nº obra / Body number is required
12.2	003504200-CFG		Lateral dcho	Right lateral	Facilitar nº obra / Body number is required
13.1	003507220-CFG		Apoyabrazos costado o central izdo	Left bodyside complet armrest	Facilitar nº obra / Body number is required
13.2	003507220-CFG		Apoyabrazos costado o central dcho	Right bodyside complet armrest	Facilitar nº obra / Body number is required
14	003540201G21-KIT		Almohadilla con tapas	Armrest covers	
15	002546201-KIT		Kit giro apoyabrazos	Armrest turn mechanism	
16.1	003543403-G21		Rodapie izdo	Left kick plate	
16.2	003543404-G21		Rodapie dcho	Right kick plate	
16.3	003543405-G21		Rodapie 2 brazos	2 Armrest kick plate	
17.1	000699846		Carrete cinturon 2P asiento izquierdo	2P belt for left seat	Marca R en verde
17.2	000699847		Carrete cinturon 2P asiento dcho	2P belt for right seat	Marca L en naranja

Nº	Referencia	Foto/Photo	Denominación	Description	Comentarios/Remarks
Nr	Part no.				
17.3	000699848		Carrete cinturon 3P asiento derecho	3P belt for right seat	Marca gris
17.4	000699849		Carrete cinturon 3P asiento izdo	3P belt for left seat	Marca lila
17.5	000699860		Carrete cinturon 3P "comfort belt " asiento derecho	3P "comfort belt" for right seat	Para asientos confort belt / For confort belt seat
17.6	000699859		Carrete cinturon 3P "comfort belt " asiento izquierdo	3P "comfort belt" for left seat	Para asientos confort belt / For confort belt seat
18.1	000699926		Hebilla pasillo 2P & 3P	Aisle buckle 2P & 3P	
18.2	000699928		Hebilla ventana 2P & 3P	Window buckle 2P & 3P	
18.3	000699920		Hebilla butaca trasera	Rear seat buckle	
18.4	000699930		Hebilla pasillo "comfort belt"	Aisle buckle "comfort belt"	Para asientos confort belt / For confort belt seat
18.5	000699931		Hebilla ventana "comfort belt"	Window buckle "comfort buckle"	Para asientos confort belt / For confort belt seat
18.6	000699932		Hebilla butaca trasera "comfort belt"	Rear seat buckle "comfort belt"	Para asientos confort belt / For confort belt seat
19.1	002540723-KIT		Guia exterior cinta	Belt outside guide	

Nº	Referencia	Foto/Photo	Denominación	Description	Comentarios/Remarks
Nr	Part no.				
19.2	003540720-N50		Sonrisa asiento izquierdo "comfort belt"	Belt outside guide for left seat "comfort belt"	Para asientos confort belt / For confort belt seat
19.3	003540721-N50		Sonrisa asiento derecho "comfort belt"	Belt outside guide for right seat "comfort belt"	Para asientos confort belt / For confort belt seat
20	003540706N50-KIT		Guia cinta	Belt guide	
21.1	003502001		Montaje mecanismo inclinacion izda	Left side reclining lever	
21.2	003502002		Montaje mecanismo inclinacion dcha	Right side reclining lever	
21.3	003502003		Montaje mecanismo inclinacion traseras izda	Rear seats - left side reclining lever	
21.4	003502004		Montaje mecanismo inclinacion traseras dcha	Rear seats - right side reclining lever	
22	000040402		Pomo inclinacion costado	Side recline knob	Antes/Before October 2013: Reference : 008140415. Lote mínimo/Minimum batch: 25 un.
23	000699316		Resorte gas	Gas ram	
24.1	003540301R05-KIT		Pulsadores inclinacion	Reclining buttons	Antes Octubre 2013 pulsadores con serigrafia/ Before October 2013 buttons with arrows.
24.2	003566403R05-KIT		Pulsadores inclinacion con desplazable	Reclining and sliding buttons	
24.3	003540301G26-KIT		Pulsadores sin serigrafiar grises	Grey buttons not printed	

Nº	Referencia	Foto/Photo	Denominación	Description	Comentarios/Remarks
Nr	Part no.				
25	003520303G14-KIT		Tapa hueco hebilla	Buckle hole cover	
26.1	003502507-KIT		Apoyapies R 2 posiciones	2 position footrest	
26.2	003502508-KIT		Apoyapies R 4 posiciones	4 position footrest	
A	000699703-G20		Posavasos gris	Grey cup holder	
B	000699437		Percherito retráctil	Retractable hook	