

Lista de Recambios / Spare part list

Nº Ident / Ident-no 005800100

Nombre / term Guia I



Cliente / customer

Proyecto / project

Fecha / stand November 2015



Lista de Recambios / Spare part list

Nº Ident / Ident-no 005800100

Nombre / term Guia I









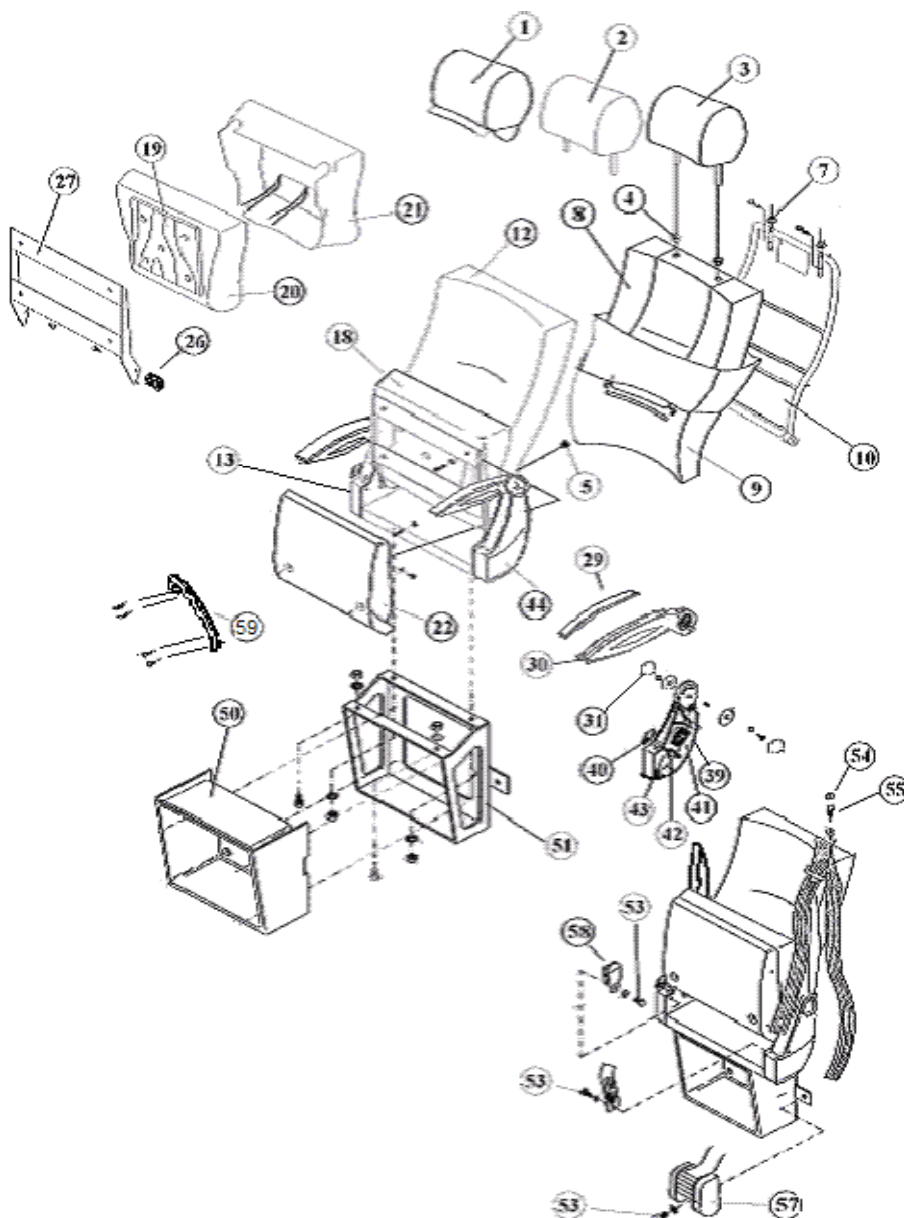

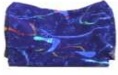















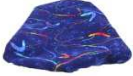

Cliente / customer













Proyecto / project







Fecha / stand November 2015



Nº	Referencia	Foto/Photo	Denominación	Description	Comentarios/Remarks
Nr	Part no.				
1	005803500-CFG		Funda Cabezal	Headrest cover	Facilitar nº obra y posicion / Body number and position is required
2.1	002110515		Cabezal vision sin tapizar	"Vision" headrest without upholstery	
2.2	002110517		Cabezal intermedio sin tapizar	"Intermedio" headrest without upholstery	
3.1	002104501		Cabezal vision tapizado	Trimmed "Vision" headrest	Facilitar nº obra y posicion / Body number and position is required
3.2	002104512		Cabezal intermedio tapizado	Trimmed "Intermedio" headrest	Facilitar nº obra y posicion / Body number and position is required
4	006140106-N50		Casquillo superior	Top cap	
5	009940015-N50		Clip de respaldo	Backrest clip	
7	006140107-N50		Casquillo inferior	Lower cap	
8	002810301		Espuma de respaldo	Backrest foam	
9.1	005803310-CFG		Funda de respaldo sin acolchar	Backrest cover without padding	Facilitar nº obra y posicion / Body number and position is required
9.2	005803330-CFG		Funda de respaldo acolchada	Backrest cover with padding	Facilitar nº obra y posicion / Body number and position is required
10	005801320N50-CFG		Armadura de respaldo	Backrest Frame	Facilitar nº obra y posicion / Body number and position is required
12	005804320-CFG		Respaldo tapizado	Trimmed backrest	Facilitar nº obra y posicion / Body number and position is required

Nº	Referencia	Foto/Photo	Denominación	Description	Comentarios/Remarks
Nr	Part no.				
13	005801103-G14		Plataforma giro cojin	Platform rotation cushion	
18	005804410-CFG		Cojin tapizado	Trimmed cushion	Facilitar nº obra y posicion / Body number and position is required
19.1	005803401		Madera del cojin standard	Standard cushion's wooden	
19.2	005803402		Madera del cojin corta	Short cushion's wooden	
20.1	002810409		Espuma de cojin F440	Cushion foam F440	
20.2	002810417		Espuma de cojin F425	Cushion foam F425	
20.3	002810415		Espuma de cojin F405	Cushion foam F405	
20.4	002810410		Espuma de cojin F370	Cushion foam F370	
21	005803400-CFG		Funda cojin	Cushin cover	Facilitar nº obra y posicion / Body number and position is required
22.1	005840402-N50		Carcasa de cojin fondo standard	Standard cushion shell	
22.2	005840404-N50		Carcasa de cojin fondo corto	Short cushion shell	
26.1	002809306		Muelle giro cojin derecho	Right spring cushion	
26.2	002809307		Muelle giro cojin izquierdo	Left spring cushion	

Nº	Referencia	Foto/Photo	Denominación	Description	Comentarios/Remarks
Nr	Part no.				
27	005801401-N50		Armadura de cojin	Cushion frame	
29	008540201-G21		Almohadilla apoyabrazos	Armrest pillow	Antes/before 2014: 008540201
30	005847201-G14		Cuerpo apoyabrazos	Armrest body	
31	008540414-G21		Tapa apoyabrazos	Armrest cover	Antes/before 2014: 008540414
39.1	005847202-G14		Carcasa lateral brazo derecha	Right lateral armrest shell	
39.2	005847203-G14		Carcasa lateral brazo izquierda	Left lateral armrest shell	
40	009540302-N50		Pomo inclinacion derecho	Right reclining knob	
41	008809301		Muelle espiral inclinacion	Reclining spiral spring	
42	008864101		Sector inclinacion	Reclining sector	
43	008809402		Resorte accionamiento derecho	Right drive spring	
44.1	005804210-CFG		Lateral pasillo	Aisle lateral	Facilitar nº obra y posicion / Body number and position is required
44.2	005804200-CFG		Lateral ventana	Window lateral	Facilitar nº obra y posicion / Body number and position is required
50	002840401		Carcasa soporte cojin	Cushion support shell	

Nº	Referencia	Foto/Photo	Denominación	Description	Comentarios/Remarks
Nr	Part no.				
51	002801701-N50		Soporte cojin standard	Standard cushion support	Facilitar nº obra y posicion / Body number and position is required
53	001208203		Tornillo fijacion hebilla	Buckle screw	
54	000699528		Caperuza tornillo cinturon	Hood for belt screw	
55	000600303		Tornillo fijacion cinturon	Belt screw	
57	000699804		Carrete 3 puntos	Belt	
58	000699907		Hebilla	Buckle	
59	000699409		Asa de cojin	Handle for cushion	