



Torcbrain® Cordless Portable Valve Actuator System



Torcbrain® - The smart choice

Torcbrain® Portable battery Valve Actuator Tools can be utilised in situations where Valve size, pressure rating, or environmental conditions typically necessitate a permanent, dedicated actuator or work crew



- +** Maintenance-free, brushless EC-Tec Motor
- +** Microprocessor controlled, clutchless torque shut-off and overload protection system
- +** Optional, bi-directional revolution counter
- +** Quality tool & Accessories Made in Germany
- +** 4-Speed Gearbox for selection of 44 torque settings
- +** Fingertip control for smooth on/off, forward and reverse operation
- +** Adjustable Precision Torque Control dial wheel
- +** Swivel-drive unit, perfect for hard to reach valves
- +** Maintenance-free Planetary Gearbox
- +** Quick-fit Torque arm support bars
- +** Unique quick-change system accessories adaptor for fast and easy tool change
- +** Powerful 18V 5.0Ah or optional 8.0Ah Li-Ion battery for long service periods



Torcbrain® - The complete, versatile system solution

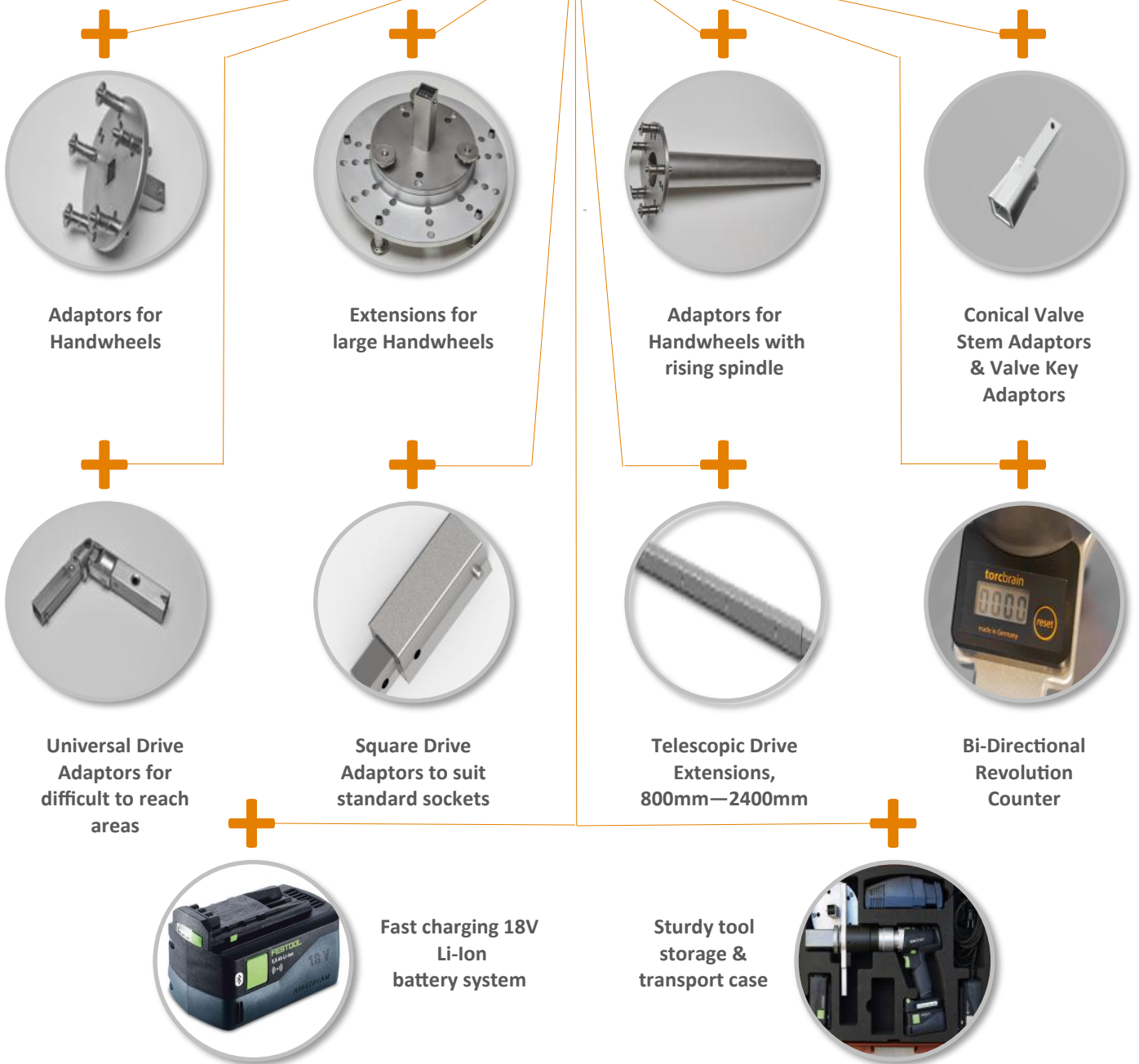



Safe - Time



- ⇒ Quick tool system set-up
- ⇒ Fast tool speed, fast operation
- ⇒ Does not rely on permanent power supply
- ⇒ Fingertip control for on/off, forward and reverse function
- ⇒ Quick change of system accessories using one hand only

Safe - Money



- ⇒ More cost-effective than dedicated actuators
- ⇒ Transforms tasks typically needing a work crew into a one-person operation
- ⇒ Compatible with most valve sizes and types using a variety of quick-change system accessories

Increase - Efficiencies



- ⇒ Easy one-person set-up and operation
- ⇒ Flexible and mobile due to the cordless battery drive system
- ⇒ Lightweight, fast, accurate
- ⇒ Excellent for moving tight or partially seized valves

Reduce - Injuries



- ⇒ Prevents operator fatigue and significantly lowers the risk of workplace injuries
- ⇒ Built-in electronic torque-overload protection and automatic shut-off system, once the chosen torque is achieved, the tool shuts off automatically
- ⇒ No clutch, no ratcheting, no vibrations
- ⇒ Comfortable operation with excellent ergonomics

Improve - Maintenance



- ⇒ Providing good feedback to the operator on the valve
- ⇒ Revolution counter allows for accurate exercising of valves
- ⇒ Maximum valve protection due to adjustable torque control (44 torque settings)

Reliable - Quality



- ⇒ Made in Germany, built to last
- ⇒ High quality, maintenance free 4 speed mechanical gearbox
- ⇒ Maintenance free, efficient brushless EC Motor
- ⇒ Proven technology
- ⇒ Global & Local Support



Portable Valve Actuator Tools



| Model | Torque Range | No. of Torque settings | Max. speed rpm | Length | Dia. | Height | Weight incl battery |
|------------------|---------------------------|------------------------|----------------|-------------------|---------------------|--------------------|----------------------|
| EIT-TB300 SDT | 10-400 Nm 7- 295 ft-lb | 44 | 120 rpm | 365mm 14-3/8" | 58 mm 2-9/32" | 250 mm 9-27/32" | 4.0 kg 8 lb 13 oz |
| EIT-TB300 SDT RC | 10-400 Nm 7- 295 ft-lb | 44 | 120 rpm | 365mm 14-3/8" | 58 mm 2-9/32" | 250 mm 9-27/32" | 4.0 kg 8 lb 13 oz |
| EIT-TB900 SDT | 10—950 Nm 7—700 ft-lb | 44 | 43 rpm | 401 mm 14-3/8" | 68 mm 2-9 11/16" | 250 mm 9-27/32" | 5.7 kg 12 lb 9 oz |
| EIT-TB900 SDT RC | 10—950 Nm 7—700 ft-lb | 44 | 43 rpm | 401 mm 14-3/8" | 68 mm 2-9 11/16" | 250 mm 9-27/32" | 5.7 kg 12 lb 9 oz |

Models with code RC include a factory fitted revolution counter as pictured on the left. All tools are supplied with 1 x charger, 2 x 5.0Ah Batteries, and complete with a sturdy transport- & storage box.

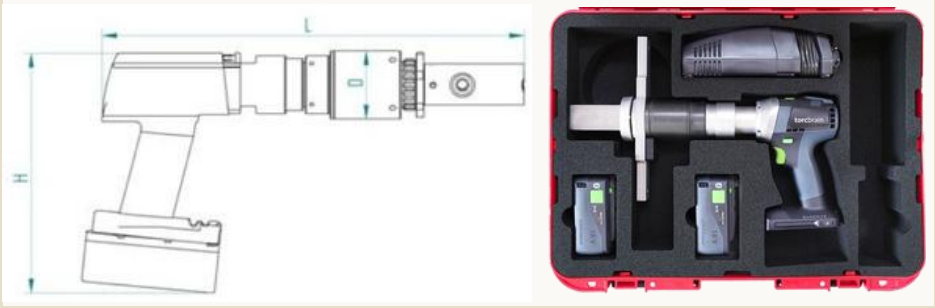

Speed and Torque Settings

The charts below show the no load speed as well as the max. torque of the tools in each gear:

Model TB300SDT

| Gear | Speed / Rpm |
|------|-------------|
| 1st | 0 - 17 |
| 2nd | 0 - 25 |
| 3rd | 0 - 80 |
| 4th | 0 - 120 |

| Gear | Max. Torque | |
|------|-------------|-------|
| | Nm | ft-lb |
| 1st | 400 | 295 |
| 2nd | 400 | 295 |
| 3rd | 140 | 103 |
| 4th | 90 | 66 |

Model TB900SDT

| Gear | Speed Rpm |
|------|-----------|
| 1st | 0 - 6 |
| 2nd | 0 - 9 |
| 3rd | 0 - 29 |
| 4th | 0 - 43 |

| Gear | Max. Torque | |
|------|-------------|-------|
| | Nm | ft-lb |
| 1st | 950 | 700 |
| 2nd | 950 | 700 |
| 3rd | 350 | 258 |
| 4th | 240 | 177 |

System Accessories / Revolution Counters / Telescopic Drive Extension

Revolution Counter

The optional revolution counter can easily be fitted to the standard Torcbrain Cordless Valve Actuators. They enable the monitoring and recording of clockwise and anti-clockwise revolutions of the handwheel or valve stems using a contactless module and easy to read digital display. The ideal solution for valves requiring a high number of revolutions or for precise valve exercising.



| Model | Description | To suit Tool | Operation | Material |
|---------|---------------------------|-----------------|---|---------------------------------|
| Z300up | Revolution Counter module | TB300 | Bi-Directional Touch Buttons | Cast housing, Sealed Electronic |
| Z900up | | TB900 | | |
| Model | Description | To suit Counter | Scope of supply | |
| Z300rep | Repair Kit | Z300up | Counter including battery and pcb holder, without housing | |
| Z900up | | Z900up | | |

Telescopic Drive Extensions

The Vario-Tele, made entirely of stainless steel, enables ergonomic height adjustment of the drive to match the operators position, making it ideal for operating valves in pits, overhead, or a distance away from the operator. The integrated quick-change system allows for height adjustment and swapping of handwheel- or conical drive adaptors with one hand, without needing any tools. Three different lengths of extensions are available. The length adjustments can be made in increments of 200mm.



| Model | Description | To suit Tool | Adjustable length mm | Material |
|-----------------|-----------------------------|--------------|----------------------|-----------------|
| Vario300Tele | Telescopic Drive Extensions | TB300 | 837 - 1437 | Stainless Steel |
| Vario300Tele120 | | | 1137 - 1937 | |
| Vario300Tele140 | | | 1437 - 2637 | |
| Vario900Tele | | TB900 | 847 - 1432 | |
| Vario900Tele220 | | | 1237 - 2212 | |
| Vario900Tele260 | | | 1432 - 2602 | |
| Vario900Tele300 | | | 1627 - 2992 | |



System Accessories / Torque Support Systems

Side Handle - Torque Reaction Arm

Torcbrain® torque reaction arms are attached to the tool to absorb the torque transferred from the tool to the valve. The side handles can be easily and quickly fitted to the tool when required and removed for tool storage. For the Tool type EIT-TB300 SDT, the torque reaction arm is constructed from lightweight Aluminium. One side handle is sufficient for torques up to 250 Nm, for higher torques of up to 400Nm we recommend using two handles fitted to the tool. For the model EIT-TB900 SDT, the torque reaction arms are made from stainless steel. Two arms are required to manage the significantly higher torque of this model. The optional Foam cover softens the pressure applied to the hips of the operator.



| Model | Description | Length mm | Material | Weight ea. kg |
|---------------|---|-----------|-----------------|---------------|
| Handle 300 | Torque Reaction arm - 1 pce | 800 | Aluminium | 0.3 |
| Handle 300-2 | Torque Reaction arm Telescopic, can be placed inside the tool storage box | 800 | Aluminium | 0.3 |
| Handle 900 | Torque Reaction arms - set of 2 | 800 | Stainless Steel | 1.4 |
| HandleProtect | Foam Cover to suit all types (1) | | | 0.3 |

Foot Support System

In applications where a side handle used as torque reaction arm is not practical or possible, the Foot Support System has been designed to be placed on the ground, allowing an ideal transfer of the torque to the ground without the need for a side handle to be held by the operator. Optional and removable spike inserts can provide further support when using the system on soft ground or on walkway grates. The tool is adjustable in height using a telescopic pipe (shown in yellow and red). The rectangular base frame (light blue) can be swiveled to adjust the position to uneven surfaces and can be used on its own or in conjunction with the floor grates for additional support.

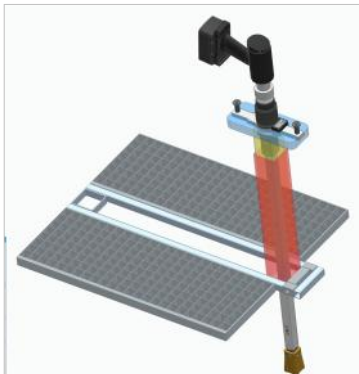

| Model | Description | To suit Tool | Max. Torque Nm | Material |
|-------------|---------------------|--------------|----------------|------------------|
| FSS-TB300 | Foot Support System | | | |
| FSS-TB300SI | Spike inserts | TB300 | 350 | Stainless Steel |
| FSS-FG300 | Floor Grates (2) | | | Galvanised steel |

Bi-Pod Support System

The Bi-Pod Support system is used where a torque reaction arm is not practical or comfortable. It can be fitted directly to the torque arm plate on the tool using a quick change locking system. The arm can be rotated in several positions to the required angle. The height can be adjusted using the telescopic arm which is fitted to a swivel base pad to ensure a firm placement on the ground. Ideal for one-person operation of the tool even at higher torques. Can be used to close or open valves by rotating the Bi-Pod.



| Model | Description | To suit Tool | Max. Torque Nm | Material |
|----------------|-----------------------|--------------|----------------|-----------------|
| FSS-TBBPSys300 | Bi-Pod Torque Support | TB300 | 400 | Stainless Steel |

System Accessories / Operation of Handwheels

Handwheel Adaptor for Valves with Non-Rising Spindles

For the operation of valves with handwheels. The quick-change driving pins Dia 10mm can be adjusted with 1 hand, without requiring any tools. Hara300/900sys to suit handwheels with 3 and 5 spokes, hara300sys-4 to suit handwheels with 4 spokes



| Model | Description | To suit Tool | Dia mm | Material | Weight ea. kg |
|--------------|---|--------------|--------|-----------------|---------------|
| Hara300sys | Adaptor for 3/5 spokes | TB300 | 150 | Stainless Steel | 1.5 |
| Hara300sys-4 | Adaptor for 4 spokes | TB300 | 150 | | 1.5 |
| Hara900sys | Adaptor for 3/5 spokes | TB900 | 150 | | 1.6 |
| Hara900sysSP | Adaptor for 3/5 spokes with 52mm long bolts | TB900 | 150 | | 1.8 |

Adaptors plate for Large Handwheels

The extension plate increases the diameter of the standard handwheel adaptor from 150 to 250mm. It is secured using three knurled screws onto the standard handwheel adaptors type Hara. The quick-change pins can be adjusted to accommodate 3/4/5 and 7 spoked handwheels without requiring any tools



| Model | Description | To suit adaptor | Dia mm | Material | Weight ea. kg |
|-----------|--------------------------------|----------------------------|--------|-----------------|---------------|
| Hara250 | Extension plate - 3/4/5 spokes | Hara300sys Hara900sys | 250 | Stainless Steel | 1.8 |
| Hara250-7 | Extension plate - 7 spokes | Hara300sysL Hara900sysL | | | |

Large Handwheel Adaptor for Valves with Non-Rising Spindles

For the operation of valves with larger handwheels with 3, 4 or 5 spokes. The hub is raised by 30mm to allow for protruding handwheel centre nuts.

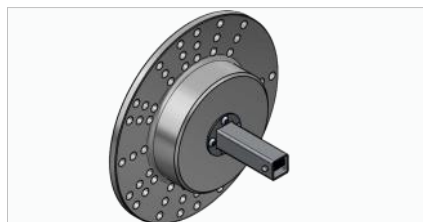

| Model | Description | To suit Tool | Dia mm | Material | Weight ea. kg |
|----------------|--------------------------|--------------|--------|-----------|---------------|
| Hara250-300sys | Adaptor for 3/4/5 spokes | TB300 | 250 | Stainless | 2.0 |
| Hara250-900sys | | TB900 | 250 | Steel | 2.0 |

Handwheel Adaptor for Valves with Rising spindles

Enables the operation of handwheels with rising spindles. The standard length is 650mm and custom lengths are also offered. The quick-change driving pins Dia 10mm can be adjusted single-handedly and without tools, to accommodate 3 or 5 spoked handwheels. The Inner diameter of the tube extension is 56mm and is suitable for spindles up to 50mm in Dia.



| Model | Description | To suit | Dia | Length | Material |
|-----------------|-------------------|---------|-----|-----------|-----------------|
| Hara300sysL650 | Handwheel Adaptor | TB300 | 150 | 650 | Stainless Steel |
| Hara300sysL xxx | Handwheel Adaptor | TB300 | 150 | 50 - 1000 | |
| Hara900sysL650 | Handwheel Adaptor | TB900 | 150 | 650 | |
| Hara900sysL xxx | Handwheel Adaptor | TB900 | 150 | 50 - 1000 | |

System Accessories / Operation of Handwheels & Other System Adaptors

Handwheel Adaptor for larger rising spindles, with slotted tube for spindle position inspection

The same features as the above shown product, but to suit valve spindles with larger diameters. The ID of the tube extension is 84mm and the tube is slotted to provide visibility of the position of the rising spindle.



| Model | Description | To suit Tool | Dia mm | Length mm | Material |
|--------------------|-------------------|--------------|--------|-----------|-----------------|
| Hara300sysL650-84 | Handwheel Adaptor | TB300 | 150 | 650 | Stainless Steel |
| Hara300sysL xxx-84 | Handwheel Adaptor | TB300 | 150 | 50 - 1000 | |
| Hara900sysL650-84 | Handwheel Adaptor | TB900 | 150 | 650 | |
| Hara900sysL xxx-84 | Handwheel Adaptor | TB900 | 150 | 50 - 1000 | |

Handwheel Adaptor for handwheels with 6 spokes and Rising spindle

This adaptor can be used on handwheels with 6 spokes and rising spindle, specifically for handwheels with spokes around 30mm in diameter. The adaptor's recess measures 350mm in diameter and 40mm in depth.

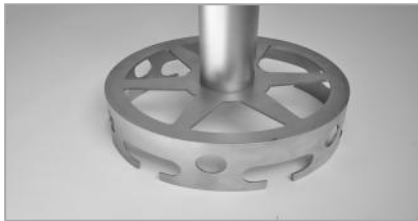

| Model | Description | To suit Tool | Dia mm | Length mm | Material |
|------------|-------------------|--------------|--------|-----------|-----------------|
| Hara350sys | Handwheel Adaptor | TB300 | 350 | 425 | Stainless Steel |

Replacement Pins for Handwheel adaptors

Quick-change spring loaded driving pins. Can be adjusted with one hand, without requiring any tools.



| Model | Description | To suit Adaptor |
|---------|------------------------------------|------------------------------------|
| KSB1015 | Connector Pin Dia 10mm, 15mm long | Hara300Sys, Hara300SysL |
| KSB1025 | Connector Pin Dia. 10mm, 25mm long | Hara900Sys, Hara900SysL Hara250 |
| KSB1250 | Connector Pin Dia. 12mm, 52mm long | Hara900sysSP |

Universal Joint Adaptors

Universal Joint Adaptors are designed to allow easier access to hard to reach valves. They fit between the tool and the system adaptors or onto the end of the telescopic drive extension and the system adaptors.



| Model | Description | To suit Tool | Material |
|-----------|-------------------------|--------------|-----------------|
| Kardan300 | Universal Joint Adaptor | TB300 | Stainless Steel |
| Kardan900 | | TB900 | |

Up- and Downsize Adaptors

Adaptors to use accessories for the smaller model EIT-TB300 on the larger model EIT-TB900 and vice versa.



| Model | Description | To suit Tool | To use Adaptors from Tool | Material |
|-------------|-------------|--------------|---------------------------|-----------------|
| RZ300-900* | Adaptor | TB300 | TB900 | Stainless Steel |
| RZ900-300** | | TB900 | TB300 | |

*Please note that max. torque using the adaptor RZ900-300 is 400Nm, higher torque settings on the TB900 tool will damage the accessories of the smaller tools type TB300.

System Accessories / Operation of Valves with Valve Stem or Keyway Spindle

Conical Adaptors

Designed to operate the valve directly via the valve stem.



| Model | Description | To suit Tool | To suit stem dia. mm | Material |
|--------------|-----------------|--------------|----------------------|-----------------|
| KOS17/19-300 | Conical Adaptor | TB300 | 17-19 | Stainless Steel |
| KOS19/22-300 | | | 19-22 | |
| KOS24/27-300 | | | 24-27 | |
| KOS27/32-300 | | | 27-32 | |
| KOS32/36-300 | | | 32-36 | |
| KOS40/50-300 | | | 40-50 | |
| KOS48/54-300 | | | 48-54 | |
| KOS27/32-900 | | TB900 | 27-32 | |
| KOS32/36-900 | | | 32-36 | |
| KOS36/42-900 | | | 36-42 | |
| KOS40/50-900 | | | 48-54 | |
| KOS48/54-900 | | | 40-50 | |

Valve Spindle Keyway Adaptors

Valve Spindle Keyway System Adaptors are used to connect the tool directly to the valve keyway spindle. They are made to order according to your requirements and fit directly to the system adaptor of the tool and/or the drive extensions



| Model | Information required | To suit Tool | Material |
|---------------|-------------------------------------|--------------|-----------------|
| Made to order | Dia. Of valve key Size of keyway | TB300 | Stainless Steel |
| Made to order | | TB900 | |

Square Drive Adaptors

Square Drive Adaptors with a 3/4" male square drive, enabling the use of standard sockets or existing tooling.



| Model | Description | To suit Tool | Material |
|------------|-----------------------------------|--------------|-----------------|
| Sys300-34M | Square Drive Adaptor 3/4" Male | TB300 | Stainless Steel |
| Sys900-34M | | TB900 | |

Specialty Adaptors

We can manufacture custom adaptors to suit your individual requirements. Please contact us

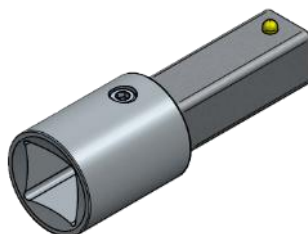
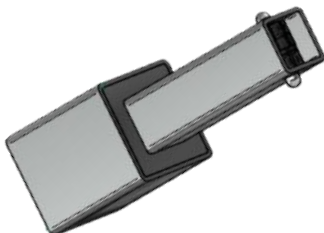

System Accessories / Batteries and Chargers

Li-Ion Battery Packs

The standard 18V, 5.0 Ah Torcbrain Battery packs, compatible across our entire range of tools and applications, are designed to meet the demands of professional uses. This robust power source, in conjunction with our high-efficiency EC-TEC brushless Tool motors, delivers exceptional performance, maximizing both power output and run time per charge.

Our AIRSTREAM technology further enhances efficiency by actively cooling the battery pack during the charging process, both before and during charging, ensuring minimal downtime and rapid return to service at peak power.

For applications requiring extended run times, optional 8.0 Ah battery packs are available, providing a 60% increase in operational time compared to the standard 5.0 Ah pack.



| Model | Description | To suit Tool | Power | Battery type | Weight kg |
|----------|--------------|--------------|-----------|--------------|-----------|
| BP1850Li | Battery Pack | TB300 | 18V 5.0Ah | Li-Ion | 0.7 |
| BP1880Li | | TB900 | 18V 8.0Ah | | 1.0 |

Battery Chargers

The Torcbrain rapid charger can charge all battery packs from the 18V 5.0 Ah and 8.0Ah sizes. It demonstrates its full ability when used in conjunction with the 8.0 Ah Li High-Power battery pack after heavy-duty applications which heat up the battery pack considerably. With its active, intelligent air cooling before and during the charging procedure, the charger ensures that Airstream battery packs are ready for use again extremely quickly – for example, the 8.0 Ah Li-High Power battery pack is ready for use again in just 27 minutes. The LED display provides a complete overview, indicating the charging progress and remaining charge time at any time.



| Model | Description | To suit Tool | Voltage | Charging Power | Weight kg |
|-------------|------------------------|----------------|-------------|----------------|-----------|
| TBLG6-SCA16 | Battery Pack Airstream | TB300 TB900 | 220V - 240V | 16 A | 1.1 |
| TBLG6- | Battery Pack | TB300 | 110V—120V | 16 A | 1.1 |

On its two spaces, the DUO rapid charger charges two battery packs at the same time. Particularly practical: You no longer need to look for another socket for a second charger – making work easy and saving time on construction sites, in workshops and in vehicles. Suitable for all 18V battery packs. The separate LED indicators for charging progress on the two charging spaces indicate the current charge status of each battery pack at any time.



| Model | Description | To suit Tool | Voltage | Charging Power | Weight kg |
|-----------|-------------------------|----------------|-------------|----------------|-----------|
| TBLG6-Duo | Charger for 2 Batteries | TB300 TB900 | 220V - 240V | 16 A | 1.5 |

