

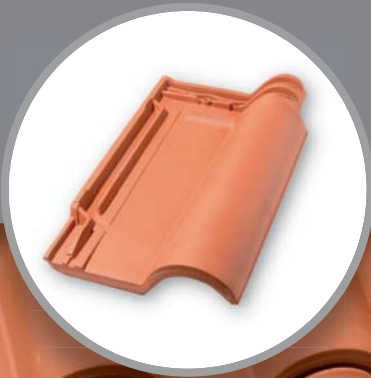

The importance of choosing well



clay roof tile
lógica lusa



Colour: RED

The logic of the leader

Perfect fittings

Weatherproof and perfect fitting

Its deep interlock ensures resistance to weather lightness and easy fixing, making of the Logica an easy and safe tile.



Subject to specific conditions (see next page)

Sharp ribs

Colour: RED



Easy setting up

Low water absorption and great resistance to transit

As it is made with state-of-the-art technology, using individual H-cassette supports, plaster moulds and selected clays to support the highest kiln temperatures.



N AENOR EN 1304



CERTIF



CE EN 1304



APCER ISO-9001



IQNET ISO-9001

Regulation:	UNE EN 1304
Installation regulation:	UNE 136020
Impermeability test:	1 UNE EN 539-1 Method 2
Fire resistance:	Class A1 UNE EN 13501-1
Frost resistance:	150 cycles UNE EN 539-2 Method E
Transverse breaking strength:	≥ 1200 N UNE EN 538

Colour: AZAMOR



colours



RED



CANELA



AZAMOR



GRAFITE



BLUE COBALTO



STRAW



MAGMA



SAHARA



ZIMBRO



EBANO



COBRE



JADE



CAMEL

Clay roof tiles are natural products therefore small variations in colour might occur as a result of the production process. The printing process of this catalogue does not guarantee that printed colours will accurately match to actual roof tile colours.

Dimensions in cm.

1 cm = 0.3937 inches - 1 square metre = 10.764 square feet - 1 kg = 2.2046 lbs.

Universal ridge

Weight per unit (kg): **3.80**
Un./lm: **2.4**

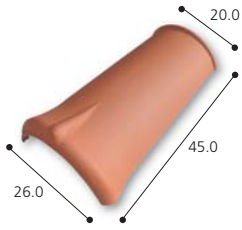

Universal hip end

Weight per unit (kg): **3.90**

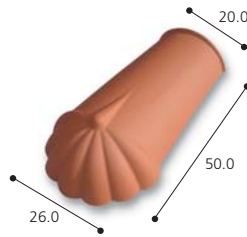

Right verge

Weight per unit (kg): **2.90**
Un./lm: **2.6**

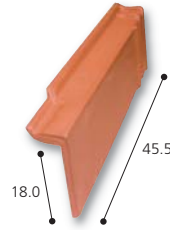

Left verge

Weight per unit (kg): **2.90**
Un./lm: **2.6**

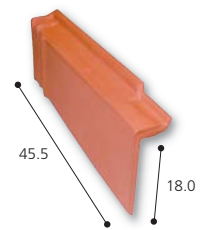

Universal verge

Weight per unit (kg): **3.00**

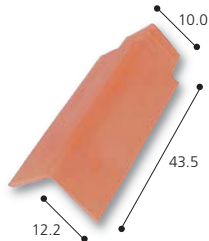

3 ridge junction

Weight per unit (kg): **5.00**

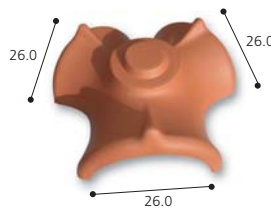

3 ridge junction

Weight per unit (kg): **5.30**

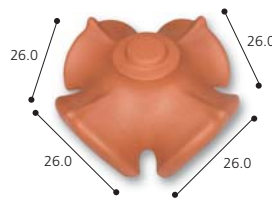

Universal ridge end cap

Weight per unit (kg): **3.90**

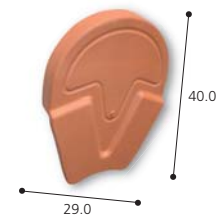

Wedge

Weight per unit (kg): **0.90**

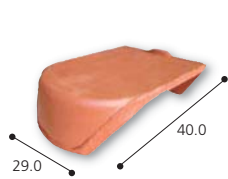

Half tile

Weight per unit (kg): **2.30**

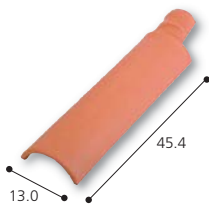

Double tile

Weight per unit (kg): **5.40**



Ventilation tile

Weight per unit (kg): **4.20**

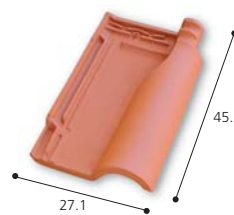

Bird stop

Weight per unit (kg): **0.55**

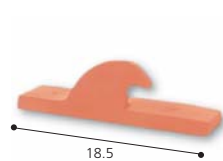

The dimensions and weights are provided as a guideline. Tejas Cobert recommends on-site control and verification for all its products.

Roofing components recommended for dry installation

Easyform

Fully waterproof band, suitable for sealing between surfaces, chimneys, pillars, etc., with tiles. It is highly flexible thanks to its corrugated aluminium structure, which allows it to extend an additional 60% of its length. The material adapts easily to the contours of the various roof tile profiles and is particularly effective in corners. The back part with butyl adhesive makes it very resistant and does not suffer any kind of lifting with wind, water, sun or other bad weather.



Material: **Aluminium-lined crepped with complete back finish using butyl self-adhesive.**

Dimensions: **0.3 x 5 m.**

Weight: **2.3 kg.**

Colours: **Grey – brown - red.**

Figaroll Plus

An optimal rollable hip and ridge solution using an innovative channel system that offers perfect roof ventilation and high protection against intrusion of driving rain or snow.

Quick, easy and clean to install. Suitable for all type of tiles.



Material: **Lateral laps made from mouldable aluminium and deformable up to 50%, containing water-repellent polypropylene in its central area and a double ventilation channel with a system of geometric openings for optimized ventilation (150 cm²/ml) while providing total protection against outdoor elements.**

Dimensions: **0.34 x 5 m.**

Weight: **1.5 kg. approx.**

Colours: **Red, anthracite grey and brown.**

Eaves batten

It allows lifting the first row of tiles in eaves and hips to provide proper micro-ventilation to the roof, preventing birds going under the roof. It can be used with any type of roof tiles.



Material: **Polipropylene.**

Dimensions: **10.5 cm x 1 m.**

Weight: **0.17 kg.**

Colours: **Grey.**

Cobert Film 270 gr.

Polypropylene multi-layer sheet. It waterproofs the space under roof tiles, protecting the support structure from dust and penetration of snow. It prevents condensation due to its high level of breathability.



Material: **4 layers of waterproof and breathable fabric with two butyl strips on the back and fibre mesh layer for reinforcement.**

Dimensions: **1.5 x 30 m.**

Weight: **270 gr/m².**

Colours: **Grey.**

The complete range of components can be found on www.tejascobert.com

technical specifications

Type:	Double lap, double interlocking
Laid:	Straight bond
Dimensions overall (cm):	45.2 x 27.1 (Red, Magma) 44.9 x 26.9 (Canela, Azamor, Grafite, Blue Cobalto, Straw, Magma, Sahara, Zimbro, Ebano, Cobre, Jade, Camel)
Weight per unit (kg):	3.6 (Red, Magma, Canela, Azamor, Grafite, Blue Cobalto, Magma, Sahara, Zimbro, Ebano, Cobre, Jade, Camel) 3.4 (Straw)
Tiles /sqm:	12
Weight /sqm:	45.6
Gauge (cm):	38.0 (Red, Magma) 37.5 (Canela, Azamor, Grafite, Blue Cobalto, Straw, Magma, Sahara, Zimbro, Ebano, Cobre, Jade, Camel)
Cover width (cm):	21.7
Battens (m /sqm):	2.7
Tiles per pallet:	280 (Other configurations available)
Weight per pallet (kg):	1042

The figures in this document are nominal and comply with regulatory tolerances.
1 mm = 0.03937 inches - 1 square metre = 10.764 square feet - 1 kg = 2.2046 lbs.

Tejas Cobert reserves the right to change the dimensions, weights and units per pallet of its products without prior notice. For further information, check the updated technical features in www.tejascobert.com or contact Customer Support Service.



ICE RESISTANCE



VERY LOW ABSORPTION



MAXIMUM IMPERMEABILITY

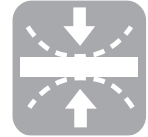

HIGHEST BREAKING STRENGTH



H-CASSETTE PRODUCTION (INDIVIDUAL SUPPORTS)



PLASTER MOULDS



Commercial Guarantee

Our tiles are guaranteed for a period, starting from the manufacture date, against breakages, cracks, or flaking caused exclusively by frost, as long as this is solely due to manufacturing defects. The granted guarantee is limited to the replacement of the defective tiles, which are supplied free ex works, and therefore will not cover the cost of removing the defective tiles or transporting and laying the replacement tiles, or of any other indirect damage that may have occurred.

It is understood that this guarantee will only apply if the supplied tiles were installed in accordance with our Tile Laying Manuals and the regulations in force in the place of installation and, in particular, the roof

where the tiles are laid are sufficiently ventilated, and said roof is correctly sloped. The guarantee will only apply after full payment for the supplied tiles and following due inspection of the alleged defects by our personnel. Furthermore, in order for the guarantee to be valid, the client must be in possession of the corresponding commercial guarantee certificate duly stamped by the Company.

The granted guarantee is a commercial guarantee and therefore separate and unrelated to the guarantees granted by the legal regulations in force.



Areas of application

Taking into account the altitude, the force of the prevailing winds, rainfall rates and frequency of storms, three basic climatic zones can be considered:

- Zone 1: interior areas with levels lower than 200 m altitude.
- Zone 2: interior areas with levels up to 500 m altitude and sea bordering areas.
- Zone 3: mountain and high mountain areas, as well as ocean-bordering areas.

Besides these three areas, it should be considered the climatological effects which may result from the local situation of each one, with three types of different situations in each area.

- **Protected Situation:** hollow surrounded by hills that protect from dominant or stronger winds.
- **Standard Situation:** plain or plateau with minor drops.
- **Exposed Situation:** strongly windswept areas, littoral up to 5 km off the shore, islands or narrow peninsulas, estuaries or steep-banked bays, narrow valleys, isolated mountains and mountain passes.

However, in each country the current legislation for installation and tile roofing building must be complied.

Installation pitches

The minimum pitch varies depending on the area and location of the roof, which shall never be less than specified in the following table.

AREA	LOCATION	MINIMUM PITCH		
		Gable length up to 6.5m	Gable length from 6.5m up to 9.5m	Gable length from 9.5m up to 12m
AREA 1	Protected	25% - 14°	26% - 15°	27% - 15.5°
	Normal	25% - 14°	28% - 16°	32% - 18°
	Exposed	33% - 18.5°	35% - 19.5°	42% - 23°
AREA 2	Protected	25% - 14°	28% - 16°	30% - 17°
	Normal	27% - 15.5°	32% - 18°	35% - 19.5°
	Exposed	37% - 20.5°	39% - 21.5°	45% - 24.5°
AREA 3	Protected	27% - 15.5°	30% - 17°	35% - 19.5°
	Normal	30% - 17°	36% - 20°	40% - 22°
	Exposed	40% - 22°	43% - 23.5°	50% - 26.5°

Roof ventilation

In the case of non ventilated roofs, microventilation must be provided under the tiles to prevent condensation, improving the hygrothermal behaviour of the roof, as well as the conservation of tile supports and securing materials. The following must be provided in order to obtain effective microventilation:

• Air flow entry:

To be provided from the lowest part of the roof, through the roof eaves. The eave combs and ventilation tiles are indicated for this purpose. A ventilation tile shall be placed every 10m² of roof, with a minimum of two per gable, placed symmetrically in the upper third of the gable. If it were not possible to provide ventilation through the roof eaves, the same number of ventilation tiles shall be placed in the lower third of the gable.

• Inner circulation:

It is not advisable to extend it beyond 12m. It shall be executed in upward direction, from the entry to the ridge. The greater difference in height between the entry and exit of air will provide better circulation.

• Air flow exit:

It shall be executed along the ridge using a perforated steel profile that supports the ridge accessories, or near the ridge through chimneys or ventilation tiles. An air exit shall be placed at least every 10m², with a minimum of two per gable. When placing tiles above steam barriers or impermeable layers, ensure a space is provided under the tiles with battens to provide microventilation and water evacuation.



Pitch and tile fixing per m²

Fixing levels: all tiles and accessories shall be secured in eaves, sides, ridges, hips, valleys and other singular points.

- **Level A:** Tiles shall be supported simply on battens or fixed with mortar; in this case the tile heels on the lower face shall be embedded in it. Cobert recommends dry installation for its tiles.
- **Level B:** Tiles shall be supported on battens, which shall prevent sliding due to the heels in their lower face.
- **Level C:** Tiles shall be fixed, at a minimum proportion of one in five, at regular intervals on battens with nails, screws, hooks, etc. as per the following table:

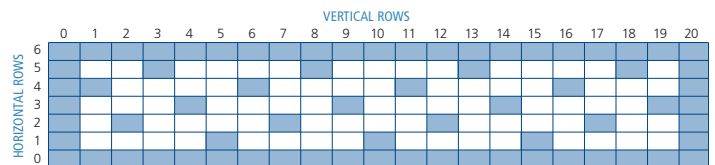
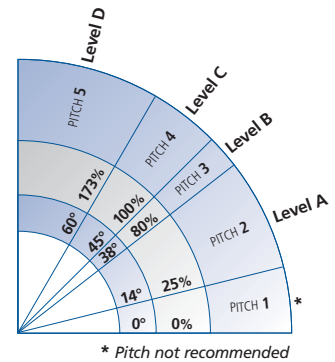

- **Level D:** For roofs with pitch exceeding 173% or 60°, or in areas with strong winds, exposed locations, or basic seismic acceleration >0.12g, all tiles shall be fixed on battens with nails, screws, hooks, etc.

Longitudinal and transversal sections

Cobert recommends practical measurement on site layout.

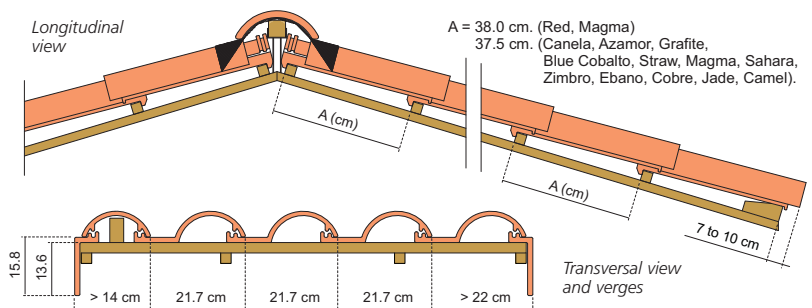

DISTRIBUTOR:



rooflescobert@uralita.com • Fax: +34 967 31 81 79
Customer Attention Service: +34 967 31 88 10

www.tejascobert.com