

# OWNER'S MANUAL

**GECKO® EXODUS ATOM MXR 1208A**



[www.geckomusicgroup.com](http://www.geckomusicgroup.com)



# SAFETY INSTRUCTIONS & SYMBOLS GUIDE

For your own safety and to avoid invalidation of the warranty, all text marked with these symbols should be read carefully.

## SYMBOLS:

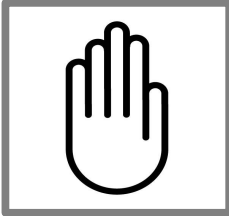

### NOTES

Contain important information and useful tips on the operation of your equipment.



### WARNING

The lightning flash with arrowhead symbol within an equilateral triangle, is intended to alert the user to the presence of uninsulated dangerous voltage within the product's enclosure that may be of sufficient magnitude to constitute a risk of electric shock.



### CAUTIONS

The exclamation point within an equilateral triangle is intended to alert the user to the presence of important operating and maintenance (servicing) instructions in the literature accompanying the appliance. Please read the manual carefully.



### HEADPHONES SAFETY WARNING

Contain important information and useful tips for headphones outputs and monitoring levels.



## SAFETY INSTRUCTIONS:

- To reduce the risk of electrical shock, do not remove covers. No user-serviceable parts inside. Please refer servicing to qualified personnel.
- To reduce the risk of electrical shock or fire, do not expose the equipment to rain or moisture.
- Do not impose unnecessary stress on your equipment (i.e. placing heavy objects on it, over screwing its mounting, etc).
- Read and keep the instruction manuals in a safe place for future references.
- Do not attempt to clean the equipment with chemical solvents as this may damage the finish. Clean only with a dry cloth.
- Do not block any ventilation openings.
- Do not install near any heat sources such as radiators, heat registers, stoves, or other apparatus that produce heat.
- Do not defeat the purpose of the polarized or grounding-type plug. A polarized plug has two blades with one wider than the other. A grounding type plug has two blades and a third grounding prong. The wide blade or the grounding prong is provided for your safety. If the provided plug does not fit into your outlet, consult an electrician for the replacement of the obsolete outlet.
- Protect the power cord from being walked on or pinched particularly at plugs, convenience receptacles, and the point where they exit from the apparatus.
- Unplug the apparatus during lightning storms or when it is not in use for a long period of time.

- Use only attachments/accessories specified by the manufacturer.
- Always shut down power supply when not in use to save energy and for a prolonged lifespan.
- Exposure to extremely high noise levels may cause permanent hearing loss. Individuals vary considerably in susceptibility to noise-induced hearing loss, but nearly everyone will lose some hearing if exposed to sufficiently intense noise for a period of time. The U.S. Government's Occupational Safety and Health Administration (OSHA) and the Singapore Workplace Safety and Health Council (WSHC) has specified the permissible noise level exposures shown in the following chart. According to OSHA and WSHC, any exposure in excess of these permissible limits could result in some hearing loss. To ensure against potentially dangerous exposure to high sound pressure levels, it is recommended that all persons exposed to equipment capable of producing high sound pressure levels use hearing protectors while the equipment is in operation. Earplugs or protectors in the ear canals or over the ears must be worn when operating the equipment in order to prevent permanent hearing loss if exposure is in excess of the limits set forth here:

Duration/Day (Hours)	dB, Sound Pressure Level (SPL)	Descriptions
	Below 90dB	Safe zone
8.00	90	Hearing damage
6.00	92	
4.00	95	
3.00	97	
2.00	100	Serious hearing damage
1.50	102	
1.00	105	
0.50	110	
0.25 or less	115	Human pain threshold

**GECKO MUSIC GROUP**

Singapore | Malaysia | Taiwan | Philippines | Canada

Email: [info@geckomusicgroup.com](mailto:info@geckomusicgroup.com) • Website: [www.geckomusicgroup.com](http://www.geckomusicgroup.com)

# FOREWORD

Dear Friends,

Thank you very much for purchasing quality products by **GECKO MUSIC GROUP**. I am very grateful that we have journeyed this far, since 2002! We have set new audio standards in the industry and we have touched and changed lives along the way! I believe our journey will not stop but continue to pursue more breakthrough findings and improvements that will change our lives for the better.

At **GECKO MUSIC GROUP** we focus on developing nothing but the best professional audio equipment and premium grade audiophile products you ever need! Our engineering team is constantly doing R&D to meet this goal. I thank God that by His grace, we have succeeded in developing the revolutionary C.R.I.S.T.A.L.® technology that has changed and is changing the way how audio is captured, encoded, reproduced and managed!

On behalf of **GECKO MUSIC GROUP**, I would like to pledge our continuing commitment to uphold our traditions in serving the music and audio communities around the world with more value-added premium quality GECKO® professional audio equipment and premium grade audiophile products!

Once again, thank you very much for your support. We trust you will love what you hear!

Yours truly,

A handwritten signature in black ink, consisting of a large, stylized 'D' followed by a series of loops and a final horizontal stroke.

Daniel Foo  
Founder/Director (R&D)  
**GECKO MUSIC GROUP**

# TABLE OF CONTENTS

<b>INTRODUCTION</b>	<b>6</b>
<b>PACKAGE CONTENTS</b>	<b>6</b>
<b>MIXING CONSOLE LAYOUT</b>	<b>7</b>
<b>CHANNEL INPUT SECTION</b> (Mic/Line Combo Inputs, Gain Control)	<b>8</b>
<b>MIC/LINE EQ SECTION</b> (Channel EQ)	<b>9</b>
<b>CHANNEL ROUTING</b> (Aux, FX, Peak LED, Pan)	<b>9</b>
<b>CHANNEL FADERS</b> (Mute, Mute LED, Channel Fader, PFL)	<b>10</b>
<b>MASTER OUTPUT SECTION</b> (Aux Send, Aux Return, FX Send, Headphones Out, Stereo - Left & Right Outputs)	<b>10</b>
<b>DSP EFFECTS ENGINE</b> (FX Program (Push), LED Numerical Display, FX Send Master)	<b>11</b>
<b>MASTER ROUTING SECTION</b> (Aux Send Master, Aux Return Master, Phones)	<b>12</b>
<b>MEDIA PLAYER/RECORDER (MPR)</b> (Bluetooth Pairing & Connections, MPR Program (Push), USB Port Playback & Recording, Mode, Rec, MPR Display)	<b>12</b>
<b>GRAPHIC EQUALIZER</b> (7-Band Graphic Equalizer)	<b>14</b>
<b>MAIN L-R MIX METERS</b> (Main L-R Mix Meters, Phantom, +48V LED, Power LED)	<b>15</b>
<b>MASTER FADERS SECTION</b> (Main Left & Right Master Faders, FX Master Fader, MPR Master Fader)	<b>16</b>
<b>REAR PANEL</b> (Power Switch, Voltage Selector, Speaker Outputs, Power Connection, Fan)	<b>16</b>
<b>CONNECTIONS</b>	<b>18</b>
<b>SPECIFICATION</b>	<b>20</b>
<b>WARRANTY</b>	<b>22</b>

## INTRODUCTION

Developed as a replacement to the highly popular EXODUS ATOM MXR 808A, the all-new GECKO® EXODUS ATOM MXR 1208A 12-channel active C.R.I.S.T.A.L.® Audiophile mixing console is a real performer in a compact package.

Many pro-users never failed to be amazed by its smooth-sounding C.R.I.S.T.A.L.® Audiophile PreAmps and the newly enhanced 24-Bit/96kHz UTOPIA DSP multi-effects processor, apart from its high-fidelity digital audio playback and C.R.I.S.T.A.L.® enhanced Bluetooth audio streaming capabilities.

With 2 x 380W of 4-tier C.R.I.S.T.A.L.® Audiophile Class-H output power onboard, the MXR 1208A packs enough power to offer a comprehensive live and installed sound solution for small-to-midsize venues with unrivaled sound quality, performance, features, and reliability.

## PACKAGE CONTENTS

- **GECKO® EXODUS ATOM MXR 1208A** 12-channel active C.R.I.S.T.A.L.® Audiophile mixing console
- IEC Power Cord



# MIXING CONSOLE LAYOUT

The **GECKO® EXODUS ATOM MXR 1208A** has comprehensive input and output sections which can be split further into various stages of processing and routing. The **EXODUS ATOM MXR 1208A** is equipped with C.R.I.S.T.A.L.® Audiophile PreAmps architecture for the most pristine quality audio capturing and reproduction. The input stages are repeated across each channel of the console, which simplifies operation and enables quick and easy location of various controls. The following pages of this manual are divided up into these stages to explain the details and function of each control.



# CHANNEL INPUT SECTION

## 1. MIC/LINE COMBO INPUTS

Your mixing console is equipped with the exceptionally transparent and high headroom C.R.I.S.T.A.L.® Audiophile PreAmps. You can connect almost all types of microphones, instruments, and audio playback devices into these combo inputs using either XLR male, ¼" (6.35mm) TRS stereo, and ¼" (6.35mm) TS mono connectors in both balanced and unbalanced configurations.

### MICROPHONES

Connect balanced microphones into these combo input sockets. *Unbalanced* microphones can be connected provided the +48V PHANTOM (31.) power is not used. Your microphones should be wired as follows:

*Balanced: Pin 1 = Ground ; Pin 2 = Signal + (Hot) ; Pin 3 = Signal - (Cold)*

*Unbalanced: Pin 1 = Ground ; Pin 2 = Signal + (Hot) ; Pin 3 = Ground*

### INSTRUMENTS

Connect balanced/unbalanced instruments or line level signals using either ¼" (6.35mm) TRS or ¼" (6.35mm) TS plugs into these combo input sockets, wired as follows:

*Balanced: Tip = Signal + (Hot) ; Ring = Signal - (Cold) ; Sleeve = Ground*

*Unbalanced: Tip = Signal + (Hot) ; Sleeve = Ground*

For more information on how you should solder your connectors, see **CONNECTIONS** on page 18.

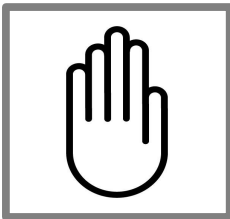

**NOTES:** We recommend the use of GECKO® TRUTH T3AL audiophile-grade signal cables and OLYMPIAN or AUDIOPHILE series audiophile-grade connectors for transparent sound transmission of your performance.

## 2. GAIN CONTROL

This control adjusts the sensitivity of both MIC and LINE inputs to the optimum level for the channel strip. Both the MIC and LINE inputs are electronically balanced. The gain is varied from +20db ~ +64dB for XLR signals and -6dB ~ 38dB for ¼" TRS/TS line level signals. Ideally, the GAIN rotary control should be adjusted so that the loudest passages of the input signal will just momentarily trigger the PEAK LED (6.). Anything longer than a momentary flicker of the PEAK LED (6.) means that the GAIN should be reduced. Using the PFL (11.) switch further down the channel strip gives a more detailed view of the channel level on the main L-R MIX level meter (30.).

The **EXODUS ATOM MXR 1208A** employs the revolutionary GECKO® C.R.I.S.T.A.L.® Audiophile PreAmps technology for pristine sound reproduction.

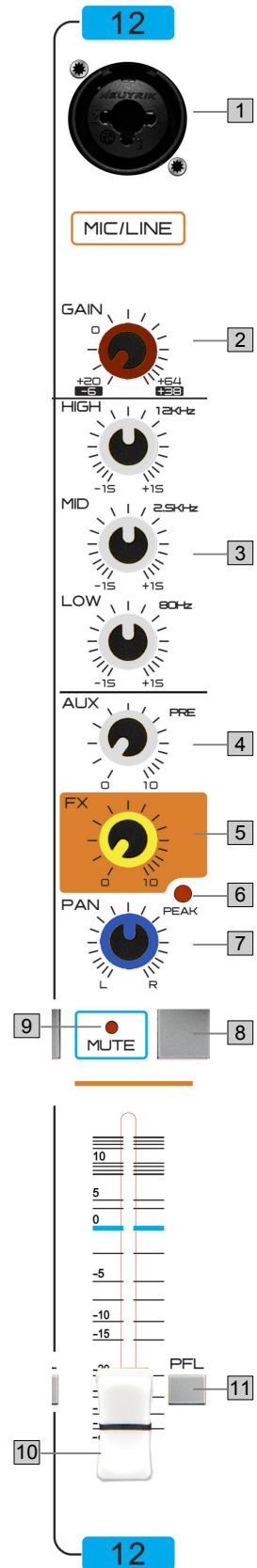



## MIC/LINE EQ SECTION

### 3. CHANNEL EQ

This three-band equalizer adjusts the channel's high, mid, and low frequency bands. Setting the knob to the 12 o'clock (center detent 0dB) position produces a flat response in the corresponding band. Turning the knob to the right boosts the corresponding frequency band, while turning to the left attenuates the band.

The following table shows the EQ type, frequency, and cut/boost range for each of the three bands.

Band	Type	Frequency	Cut/Boost Range
HIGH	Shelving	12kHz	±15dB
MID	Peaking	2.5kHz	
LOW	Shelving	80Hz	

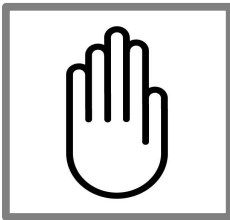

**NOTES:** Always start off with CHANNEL EQ flattened/bypassed (knobs set to center detent 0dB position). If need be, apply EQ subtly. If you find yourself repeatedly using a lot of EQ boost or cut, consider altering the sound source such as placing the microphone differently, trying a different kind of microphone, changing the strings of instruments, trying a better quality playback source, etc.

## CHANNEL ROUTING

### 4. AUX

This knob adjusts the channel's signal level sent to AUX bus. The signal sent to the AUX bus is taken after the channel equalizer and after the channel fader (post-fader). You can use this AUX to set up stage monitoring, additional effects processing, recording, broadcasting, and a separate mix to an external equipment. This AUX control has 10dB gain when turned fully clockwise. Please note the PRE indicates the AUX bus draws audio signals enhanced by the GECKO® C.R.I.S.T.A.L.® Audiophile PreAmps, and not to be confused with "pre-fader".

### 5. FX

This controls the level of signal that is sent to the effects bus and FX output from the channel. The signal is post-fader which means it is affected by the channel fader (so it stays in proportion to the signal going to main LEFT and RIGHT buses (34.)). This FX control has 10dB gain when turned fully clockwise.

### 6. PEAK LED

The PEAK LED indicator lights up red when the input signal level is 3dB below clipping.

### 7. PAN

The PAN control knob determines the stereo positioning of each mono channel signal in the main stereo LEFT and RIGHT buses (34.). For example, rotating the knob toward L moves the sound to the left (depending on the location of the knob).

# CHANNEL FADERS

## 8. MUTE

The MUTE switch when pressed in, cuts the signal sent to the main stereo LEFT and RIGHT outputs and to the effects bus. By default, the AUX bus is muted by muting the channel.

## 9. MUTE LED

The MUTE LED indicator lights up red when the channel is muted.

## 10. CHANNEL FADER

Adjusts the level of the channel signal. Use these faders to adjust the balance between the various channels.

## 11. PFL

PFL when engaged, sends the channel signal direct to monitoring. This means that the channel signal is shown on the main L-R MIX level meter (30.). Also, the signal is routed directly to the headphones output (15.). This allows the particular channel signal to be checked. If many PFLs are selected, all are routed to monitoring.

# MASTER OUTPUT SECTION

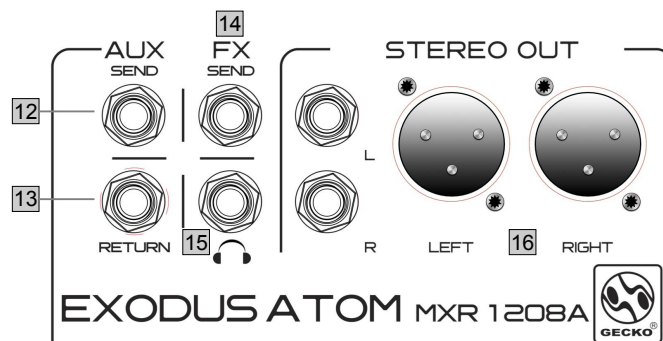

## 12. AUX SEND

This is an impedance-balanced ¼" TRS output connector operating at +4dBu line level. The AUX SEND is typically used to connect to an external effects unit or to a cue box or other such monitoring system, and for special mix requirements.

## 13. AUX RETURN

This is impedance-balanced ¼" TRS input connector. The signal received by this input connector is sent to the main stereo LEFT and RIGHT buses (34.). This input connector is typically used to receive a return signal from an external effects unit (i.e. reverb, delay, etc.).

## 14. FX SEND

If a jack is connected to the FX SEND ¼" TRS connector, this will work as an extra AUX output in post-fader (i.e. the signal routed to FX SEND is affected by the channel fader level). No wet signal is sent to this output.

### 15.

1/4" TRS stereo headphones output. 30Ω ~ 600Ω impedance headphones recommended.

### 16. STEREO OUT – LEFT (L) & RIGHT (R)

These fully-balanced XLR male and 1/4" TRS connectors output the mixed-signal whose level is adjusted by the main stereo LEFT and RIGHT faders (34.). You can use these connectors to connect to an additional power amplifier driving your additional pair of main loudspeakers or to a pair of powered loudspeakers, to cascade to another unit of **MXR 1208A**, and or to connect to an external recording device. Both outputs can be used simultaneously.

## DSP EFFECTS ENGINE

The **GECKO® EXODUS ATOM MXR 1208A** has a newly-enhanced internal 24-Bit/96kHz UTOPIA DSP processor with 99 presets. These high-quality audio effects programs are tabulated below.

24-BIT UTOPIA MULTI-FX PROCESSOR				
00 SMALL HALL	19 CHAPEL	48 STADIUM	71 PITCH SHIFT	91 DELAY & REVERSE
03 MID HALL	20 PLATE	49 AMBIENCE FX	80 CHORUS & REVERB	92 DELAY & CHORUS
06 BIG HALL	27 SPRING	50 DELAY	82 FLANGER & REVERB	94 DELAY & FLANGER
09 CHURCH	30 GATED REV	59 ECHO	84 PHASER & REVERB	96 DELAY & PHASER
10 SMALL ROOM	36 REVERSE	60 CHORUS	86 PITCH & REVERB	98 DELAY & PITCH
13 MID ROOM	40 EARLY REFL	66 FLANGER	88 DELAY & REVERB	
16 BIG ROOM	44 AMBIENCE	70 PHASER	90 DELAY & GATED	

### 17. FX PROGRAM (PUSH)

Turn this rotary encoder to select a program. The LED NUMERICAL DISPLAY (18.) will flash the selected program number.

Push the encoder to confirm the selection and the display will stop flashing and the selected program will be active.

### 18. LED NUMERICAL DISPLAY

Indicates selected program.

### 19. FX SEND MASTER

Controls the overall amount of signals (combined signals from channels FX buses) going into the internal effects processor and to the 1/4" TRS FX SEND output (14.). No wet signal will be sent to the 1/4" TRS FX SEND output (14.). This control has 10dB gain when turned fully clockwise.

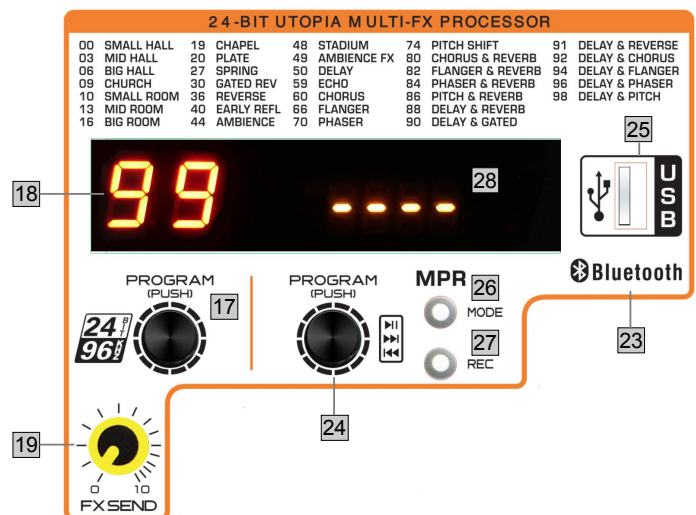

## MASTER ROUTING SECTION



### 20. AUX SEND MASTER

Controls the overall level of signals routed to the ¼" TRS AUX SEND output (12.). This control has 10dB gain when turned fully clockwise.

### 21. AUX RETURN MASTER

Controls the level of signals coming in at the ¼" TRS AUX RETURN connector (13.) into the main stereo LEFT and RIGHT buses (34.). This control has 10dB gain when turned fully clockwise.

### 22. PHONES

Controls the level of the signals output to the headphones out  connector (15.). This control has 10dB gain when turned fully clockwise.

## MEDIA PLAYER/RECORDER (MPR)

One of the great features of the **GECKO® EXODUS ATOM MXR 1208A** is its C.R.I.S.T.A.L.® Audiophile enhanced MEDIA PLAYER/RECORDER (MPR), designed for pristine quality audio playback through either the USB port or wireless Bluetooth streaming.

### 23. BLUETOOTH PAIRING & CONNECTIONS

(i). Make sure your device's Bluetooth is enabled and press the MODE button (26.) to enter Bluetooth mode. The red Bluetooth symbol above the word "BLUE" flashes, indicating Bluetooth is searching for a device to be paired.

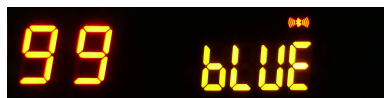

(ii). The 'MXR 1208A' will appear on your device's list of Bluetooth devices. Next, connect to pair your device. You will hear a "ding" when your device is successfully paired (red Bluetooth symbol stops flashing and a disc symbol appears) to the **GECKO® EXODUS ATOM MXR 1208A**. The "ding" is audible only if the MPR fader (36.) level is turned up. Your device's playlist is PAUSED on every new successful pairing made.

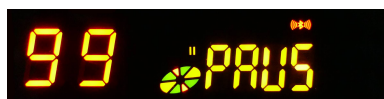

(iii). You are now ready to stream music to the **GECKO® EXODUS ATOM MXR 1208A** from the paired device. If your device is aptX™ compatible and contains high-resolution audio files, then these will be streamed in the original high-quality bit rate through the **GECKO® EXODUS ATOM MXR 1208A** 12-channel active C.R.I.S.T.A.L.® Audiophile mixing console. A spinning disc symbol, a PLAY symbol, and a green stereo streaming meter appear.



(iv). To disconnect, simply disconnect 'MXR 1208A' from your device's Bluetooth connection. You will hear a "ding" on the successful disconnection.

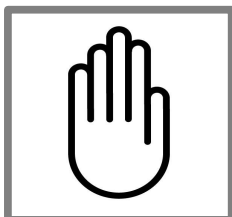

**NOTES:** In Bluetooth mode, the MPR PROGRAM (PUSH) rotary encoder's (24.) track selection (NEXT/PRE), PLAY, and PAUSE functions are used to control your device's playlist. You may also control your playlist natively on your device. Always turn up your device volume to the maximum in this mode and use the MPR fader (36.) to control the playback volume on the **GECKO® EXODUS ATOM MXR 1208A**.

#### 24. MPR PROGRAM (PUSH) ROTARY ENCODER

This rotary encoder controls the PLAY, PAUSE, NEXT, PRE functions for both USB and Bluetooth playback.



Push to play or pause track. Push to start recording/stop recording in recording mode.

Turn clockwise for next track.

Turn counterclockwise for previous track.

#### 25. USB PORT

##### PLAYBACK

Insert USB storage device (up to 64GB) with audio files here. Supported formats are MP3, WMA, WAV (16-Bit, 44.1kHz), FLAC (16-Bit, Level 5). The USB bus goes through the C.R.I.S.T.A.L.® Audiophile PreAmps for pristine quality digital audio performance. Use the MPR PROGRAM (PUSH) rotary encoder (24.) to control the playlist status.



## RECORDING

You can also record your session onto a USB storage device via this port. The recording format is in MP3 and stored in 'JL REC' folder on your USB storage device.

(i) Press REC button (27.) to enter recording standby.



(ii) Push MPR PROGRAM (PUSH) rotary encoder (24.) to start recording. Push again to stop recording. To continue recording as a separate track while in recording mode, push the MPR PROGRAM (PUSH) rotary encoder (24.) again to start recording.



## 26. MODE BUTTON

Press this button to go into Bluetooth mode (see BLUETOOTH PAIRING & CONNECTIONS (23.)) and USB playback (see USB PORT (25.) - PLAYBACK).

## 27. REC BUTTON

Press this button to go into recording mode (see USB PORT (25.) - RECORDING).

## 28. MPR DISPLAY

Digital display with mode, track, and play status information.

## GRAPHIC EQUALIZER

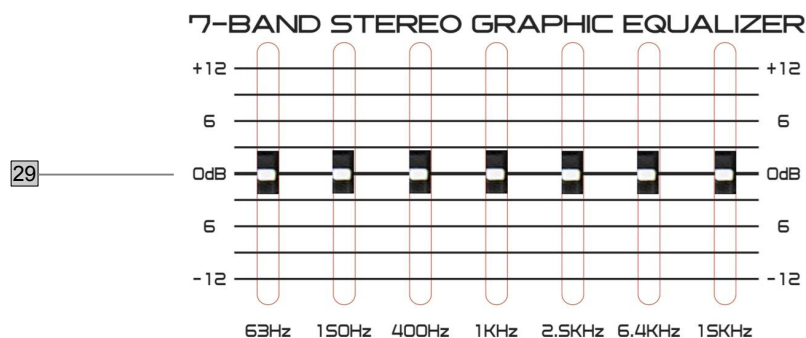

## 29. 7-BAND STEREO GRAPHIC EQUALIZER

Each slider controls a boost or a cut of up to 12dB. Setting the sliders in the center position (0dB) bypasses the stereo EQ. The graphic equalizer offers refined audio spectrum shaping and feedback control for live sound situations. In a normal application, we recommend setting the sliders to 0dB, center position (EQ bypassed).

# MAIN L-R MIX METERS

## 30. MAIN L-R MIX METERS

The main output level meters comprise a pair of 10-segment LED meters. These meters normally display the main stereo LEFT and RIGHT (34.) output levels unless PFL active.

When one or more PFL buttons (11.) are pressed in, these meters will show the output of that particular channel (or those channels) directly, allowing a more detailed analysis of the specific signal levels.

When monitoring any signal levels, it is important to prevent the red LEDs from lighting for anything longer than a brief flicker. Persistent lighting of the red LEDs indicates clipping or distortion.

## 31. +48V PHANTOM POWER SWITCH

Switches +48V DC to the channel input XLR for powering condenser microphones or DI boxes that need phantom power. When pressed, the +48V orange LED indicator (32.) lights up, indicating the +48V is active.

## 32. +48V PHANTOM POWER LED

This +48V orange LED indicator (32.) lights up, indicating the +48V DC phantom power is active - PHANTOM switch (31.) is pressed.



**CAUTIONS:** Do not connect unbalanced sources or cables to the XLR input when +48V DC is active - PHANTOM power switch (31.) is pressed. To avoid loud thumps, always turn the channel off by pressing MUTE (8.) when switching PHANTOM power switch (31.) on or off, and when plugging or unplugging microphones.

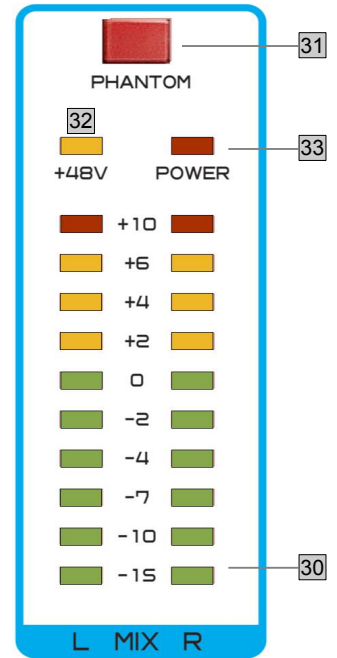

## 33. POWER LED

The red POWER LED when lit, indicates that the main power is on - POWER switch (37.) is engaged.

# MASTER FADERS SECTION

Controls output level for main stereo LEFT and RIGHT outputs (16.), the amount of effects (FX), and the level of MPR into the main LEFT and RIGHT buses.

## 34. MAIN LEFT & RIGHT MASTER FADERS

60mm smooth travel faders for main stereo LEFT and RIGHT buses with protective dust cover. The fader provides +10dB maximum boost above its normal unity gain 0dB position.

## 35. FX MASTER FADER

60mm smooth travel fader with a protective dust cover to control the level of FX going into the main stereo LEFT and RIGHT buses.

## 36. MPR MASTER FADER

60mm smooth travel fader with a protective dust cover to control the levels of MEDIA PLAYER/RECORDER (see page 12.) going into the main stereo LEFT and RIGHT buses.

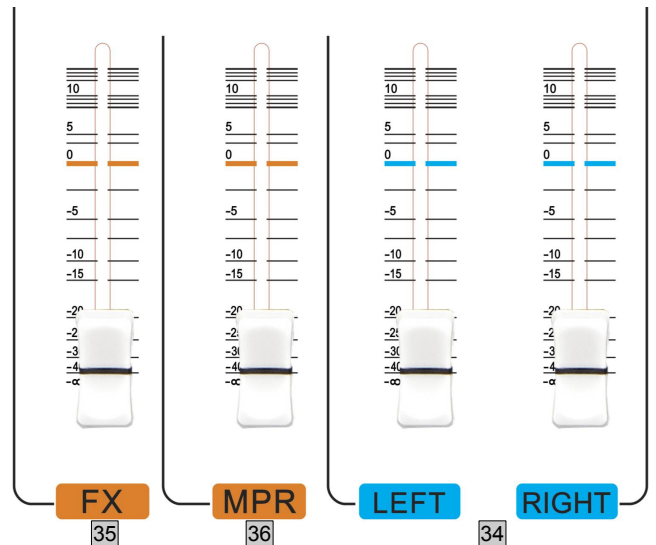

# REAR PANEL

EXODUS ATOM MXR 1208A 12-CHANNEL ACTIVE C.R.I.S.T.A.L.® AUDIOPHILE MIXING CONSOLE

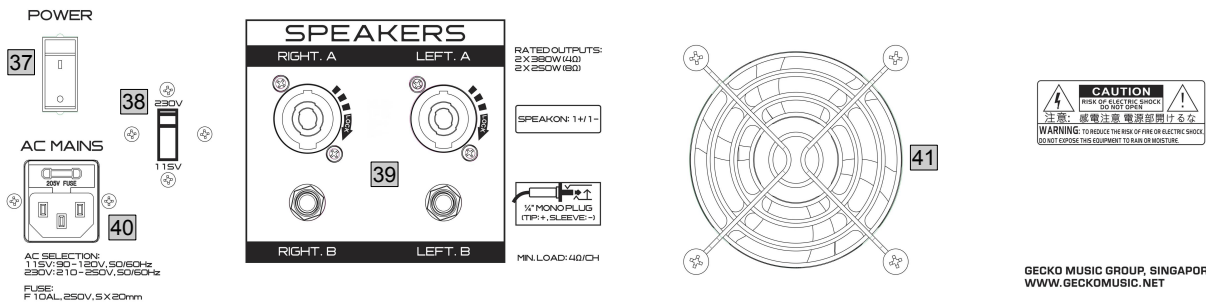

## 37. POWER SWITCH

Use this switch to power the mixing console ON [I] or OFF [O].

## 38. VOLTAGE SELECTOR

The MXR 1208A is designed for global use. It comes with a voltage selector switch.

AC selection:

115V: 90 - 120V, 50/60Hz

230V: 210 - 250V, 50/60Hz





**WARNING:** Always ensure you have the appropriate voltage rating selected on your **EXODUS ATOM MXR 1208A** before plugging into an AC outlet. Connection to an inappropriate power source may result in fire or electric shock, and extensive damage which is not covered by the warranty.

### 39. SPEAKER-LEVEL OUTPUTS

These output connections provide speaker-level output power from the internal 2 x 380W of 4-tier C.R.I.S.T.A.L.® Audiophile Class-H amplifiers in 4Ω (or 2 x 250W in 8Ω), to your passive loudspeakers.

Two professional types of connections are provided for your convenience - the SPEAKON and ¼" TS (also known as mono) connections.

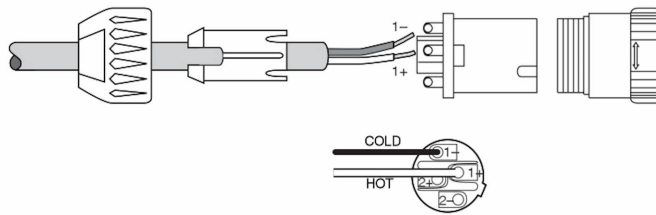

The SPEAKON outputs are wired as the following:

Pin1+ = positive (hot)

Pin1- = negative (cold)

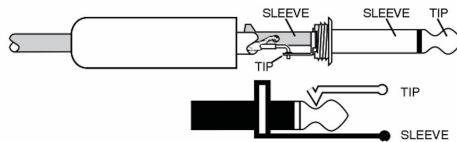

The ¼" TS (mono) outputs are wired as the following:

Tip = positive (hot)

Sleeve = negative (cold)



**CAUTIONS:** These two types of outputs are wired in *parallel*. It is possible to use both outputs at the same time. The minimum impedance that the **MXR 1208A** can handle is 4Ω per channel. If you are using both outputs per channel, make sure each loudspeaker connected is 8Ω or greater!

### 40. POWER CONNECTION

The AC inlet is an integrated IEC fused mains inlet. Connect IEC inlet to AC mains using the supplied power cord. Replace fuse only with type indicated. Use the POWER switch (**37.**) to power up or shut down the unit.

### 41. FAN

This fan provides continuous airflow for ultra-quiet air cooling. Do not block the air vents on the **MXR 1208A!**

# CONNECTIONS

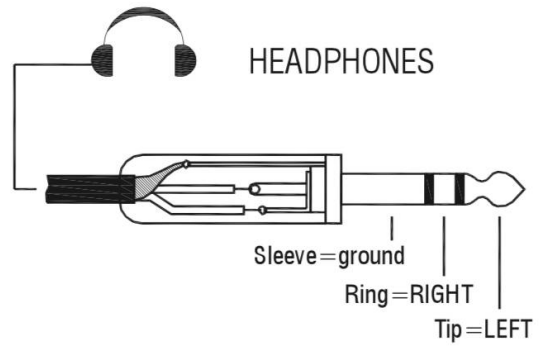
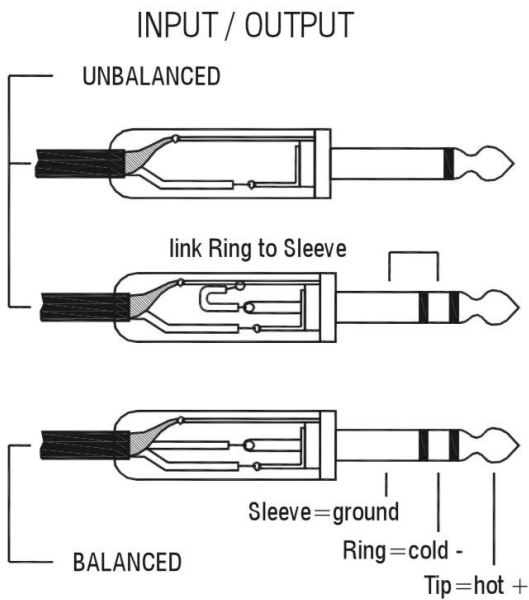
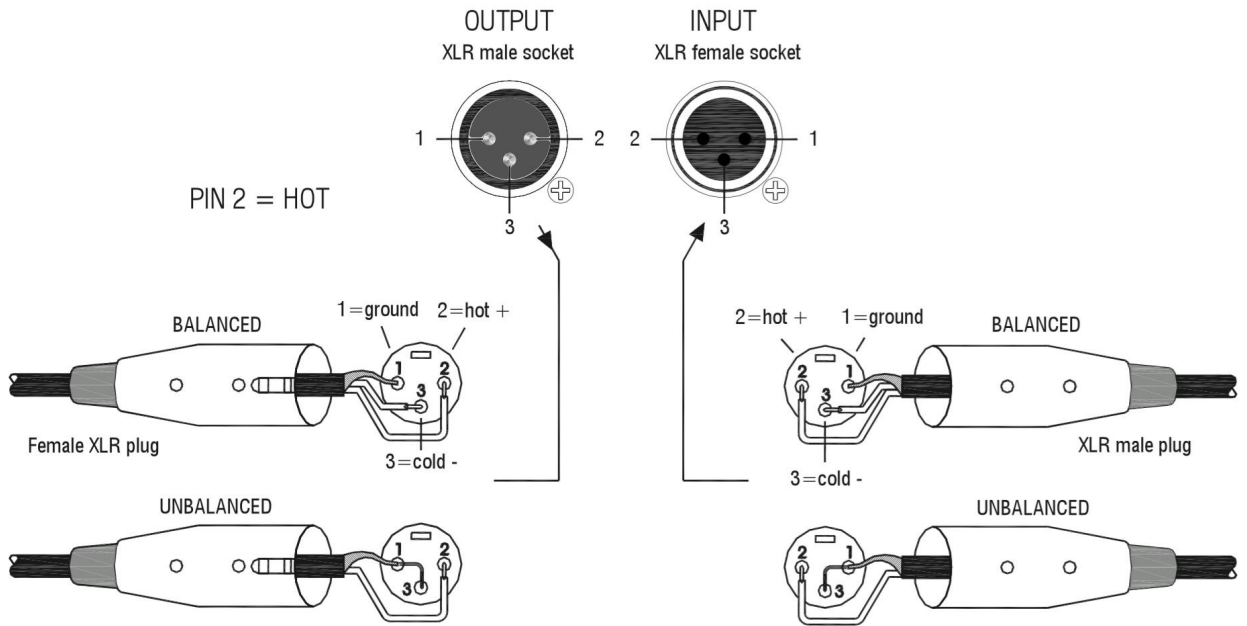

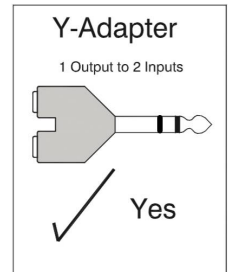
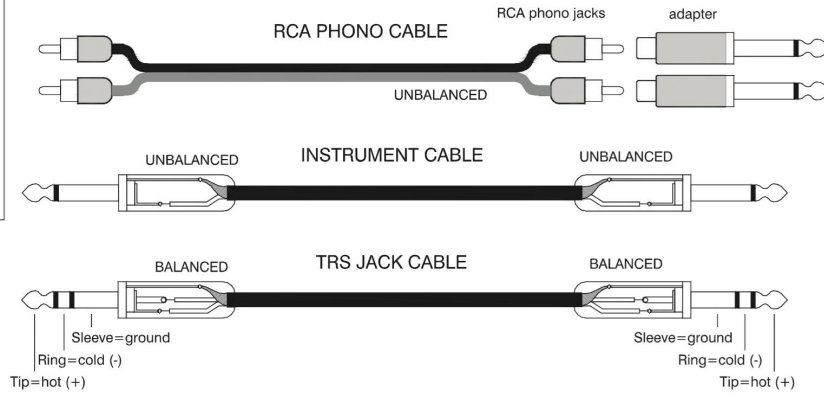
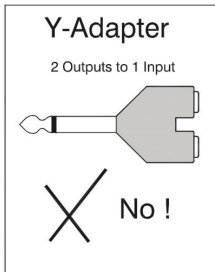

TO INPUT

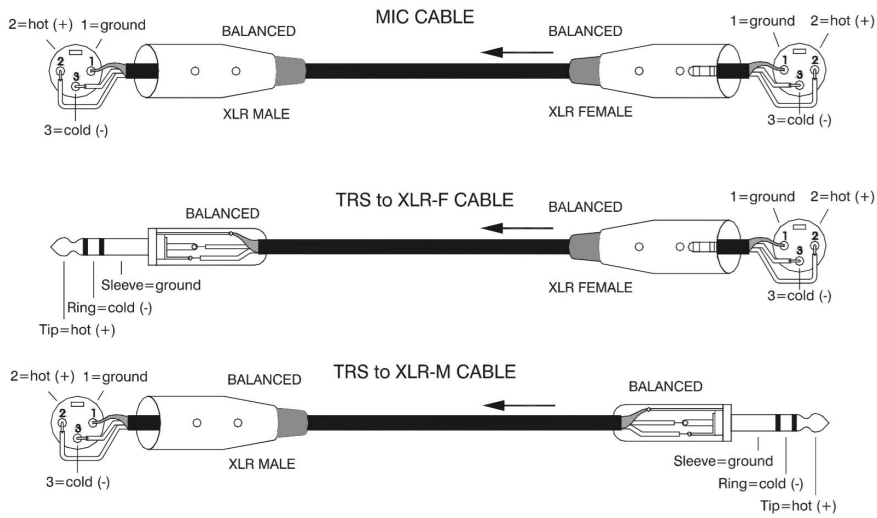

FROM OUTPUT

# SPECIFICATION

## Amplifiers:

GECKO® 4-Tier C.R.I.S.T.A.L.® Audiophile Class-H

## Rated Outputs:

2 x 250W RMS @ 8Ω

2 x 380W RMS @ 4Ω

## Pre-Amplifiers:

GECKO® C.R.I.S.T.A.L.® Audiophile PreAmps

## Frequency Response

18Hz ~ 25kHz , +/- 0.5dB

## Channels Inputs:

12 Channels Combo:

Balanced, sensitivity -60dBu ~ +14dBu

Max. Input Level: +24dBu

## Channel EQ:

High: Shelving +/-15dB, 12kHz

Mid: Peaking +/-15dB, 2.5kHz

Low: Shelving +/-15dB, 80Hz

## Stereo Out- Left & Right Outputs:

XLR Male: Balanced, <75Ω, +4dBu, +22dBu max.

¼" TRS Balanced/Unbalanced, <75Ω, +4dBu, +22dBu max.

## FX Send/Aux Send Outputs:

¼" TRS: Balanced/Unbalanced, <75Ω, -2dBu, +24dBu max.

## Aux Return Input:

¼" TRS: Balanced/Unbalanced, <10Ω, -8dBu, +24dBu max.

## Headphones:

¼" TRS Balanced: 30Ω ~ 600Ω impedance headphones recommended

## Effects:

DSP: 24-Bit/96kHz UTOPIA, 99-Presets

## 7-Band Stereo Graphic Equalizer:

Routes: Stereo Left & Right; 63Hz, 150Hz, 400Hz, 1kHz, 2.5kHz, 6.4kHz, 15kHz; +/-12dB

## Media Player/Recorder (MPR):

Reader: USB (Up to 64GB)

Playback: C.R.I.S.T.A.L.® Audiophile Enhanced MP3, WMA, WAV (16-Bit, 44.1kHz), FLAC (16-Bit, Level 5)

Recording: USB (MP3)

Bluetooth: C.R.I.S.T.A.L.® Audiophile Enhanced (up to 10m line of sight effective distance)

## Faders:

60mm Dustproof: Channel 1-12; Main - Left & Right; FX; MPR

## Loudspeakers Output Impedance:

Min. 4Ω per Channel

**Meters & LED Indicators:**

Channel: Mute (Red), Peak (Red)

L-R Mix: 10-segment (Green, Orange, Red): -15dB ~ +10dB / Channel

Master: +48V (Orange), Power (Red)

**Power Supply:**

Built-In Selectable Power Supply (IEC inputs)

Supported Voltages: 90V ~ 250V, 50/60Hz

**Physical Properties:**

Enclosure: Steel

Side Panels: ABS

Color: Metallic Grey/Black/Silver

Hardware: Non-Slip Rubber Feet (4)

Net Weight: 11.5kg

Dimension: (H) 165mm x (W) 560mm x (D) 370mm

Specifications subject to change without prior notice. Manufactured under ISO9000 certified management system.

# WARRANTY

GECKO MUSIC GROUP warrants its GECKO® products for a period of one (1) year from the original date of purchase, in accordance to the warranty regulations described below.

## What is Covered:

During the applicable warranty period, GECKO MUSIC GROUP warrants the product against defects in materials and workmanship and against malfunctions. GECKO MUSIC GROUP will remedy all such defects and malfunctions without charge for parts or labour if the warranty applies. In the case that other parts are used which constitutes an improvement, GECKO MUSIC GROUP may, at its discretion, charge the customer for the additional cost of these parts. Final determination of warranty coverage lies solely with GECKO MUSIC GROUP.

## What is Not Covered:

1. If the product needs to be modified or adapted in order to comply with applicable technical or safety standards on a national or local level, in any country which is not the country where the product was originally developed and manufactured, this modification/adaptation shall not be considered a defect in material or workmanship;
2. Normal wear and tear, in particular, of faders, crossfaders, potentiometers, keys/buttons, valves, guitar/bass strings, machine heads, pick-up covers, PVC/PU/leather covers, illuminants, and similar parts are not covered by this warranty;
3. Improper handling, neglect or failure to operate the unit in compliance with the instructions given in the user or service manuals;
4. Connection or operation of the unit in any way that does not comply with the technical or safety regulations applicable in the country where the product is used;
5. Damages/defects caused by force of nature or any other condition that is beyond the control of GECKO MUSIC GROUP;
6. Any repair or opening of the unit carried out by unauthorized personnel (user included) will void the warranty;
7. Modification or removal of serial numbers.

## Obtaining Warranty Service:

To return a GECKO® product for warranty service, first fill out the [Online Technical Report](#) on this website and submit for an authorization/service number. Write the authorization/service number so that it is prominently displayed on the outside of the shipping carton. Any products received without an authorization/service number that is clearly visible upon arrival at the factory will be refused. Enclose proof of the original delivery date or a copy of the original sales receipt/invoice. Enclose a description of the suspected defect or malfunction and the condition, if any, which caused the problem. Return the product to either GECKO MUSIC GROUP or the GECKO® Store where the purchase was made. Note: Before sending back to GECKO MUSIC GROUP, you can first check with your local GECKO® Store or authorized reseller where you buy from for support.

## Warranty Shipping:

You are responsible for prepaying shipping costs F.O.B. GECKO MUSIC GROUP, Singapore. Shipped product(s) must be properly packaged. Use original shipping cartons and packing materials where possible. GECKO MUSIC GROUP is not responsible for damages resulting from inadequate and or improper packing.

Products received with damages due to improper packaging will be deemed out of warranty.

Products which do not meet the terms of this warranty will be repaired exclusively at the buyer's expense. GECKO MUSIC GROUP will inform the buyer of such circumstance. If the buyer fails to submit a written repair order within six (6) weeks after notification, GECKO MUSIC GROUP will return the unit C.O.D. with a separate invoice for freight and packing. Such costs will also be invoiced separately when the buyer has sent in a written repair order.

#### Warranty Rights:

This warranty is exclusive and extended to the original buyer and is not transferable to anyone who may subsequently purchase this product. No other person (apart from authorized GECKO® Stores) shall be entitled to give any warranty promise on behalf of GECKO MUSIC GROUP.