

25 Years of Manufacturing Excellence



# Premier EX Pro

Combined Fire & Extinguishing  
Control Panel

# Premier EX Pro

## Combined Fire & Extinguishing Control Panel



### EX-OER (37-097)

The EX-OER output expansion relay board can be mounted inside the EX Pro to provide voltage-free changeover relay contacts for reset, mode, discharged, abort and additional 1st stage, 2nd stage output and extract fan output. One unit can be used.

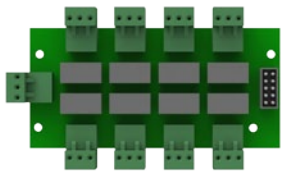

### EX-RSI (37-098)

EX-RSI is a remote status indicator connected to the EX-PRO panel via RS485 output providing the following: auto/manual mode selection, manual release, first/second stage alarm, gas discharged and abort.



The EX Pro is the latest modern designed extinguishing panel from Zeta Alarm Systems, fully complying with EN54 parts 2 & 4, and EN 12094 part 1.

Featuring a blue 4 x 20 LCD display with a list of extra features such as memory log of fire, fault and system events, adjustable flood times and countdown of extinguishing sequence.

The panel is assembled in a very modernised enclosure and construction for ease of termination.

### Features

- ✓ Integral PSU (2.0 Amp)
- ✓ 4 x 20 LCD Display
- ✓ Countdown
- ✓ Extinguishing Delay Timer (0-60 seconds)
- ✓ Flooding Time Programming
- ✓ 1.0A Bottle Output
- ✓ Optional 8 Way Relay
- ✓ Aux (Fan Output)
- ✓ Alarm/Fault log (100 Events)
- ✓ RS485 Output
- ✓ Optional 8 Way Relay Output

Indications	
Power	✓
Fault	✓
1st Stage Alarm	✓
2nd Stage Alarm	✓
Gas Fired	✓
Bottle Monitoring	✓
Manual Release	✓
Abort	✓
Auto Mode	✓
Manual Mode	✓
Control	
Double Action Manual Release	✓

# Premier EX Pro

## Combined Fire & Extinguishing Control Panel

### Technical Information

<b>Model</b>	<b>EX-PRO</b>
Part Number	37-096
Supply Voltage	230 AC +/- 10%
System Voltage	24 VDC (Nominal)
<b>Detection Zones</b>	
Zone Voltage	
Zone Capacity	32 Devices
No. of Detection Zones	2 - EOL (4.7k)
Line Monitoring for Open & Short Circuit	Yes
Max Cable Length per Zone	250m
Zone Quiescent Current	2mA max - EOL
<b>Sounder Outputs</b>	
No. of Sounder Circuits	3 (S1A, S1B for 1st Stage, S2 for 2nd Stage)
Sounder Output Rating	21-28 VDC, fused at 150mA per circuit
Max Cable Length	60m
<b>Auxilliary Outputs</b>	
No. of Auxilliary Outputs	5 (fault, 1st stage fire, 2nd stage fire, extract fan, gas fired output)
Relay Rating	(30V - 1 Amp)
<b>Extinguishant Release Outputs</b>	
Bottle Output	1.0 Amp - EOL 18K
5 Monitored Inputs	Manual release, low pressure, gas fired, auto input & abort
E.O.L Value	18K
<b>General</b>	
Battery Space	Up to 2 x 7.0 AH, 12V DC SLA batteries
IP Rating	IP32
Operating Temperature	-10 to 50°C
Box Dimensions (mm)	(W) 370 x (H) 311 x (D) 113

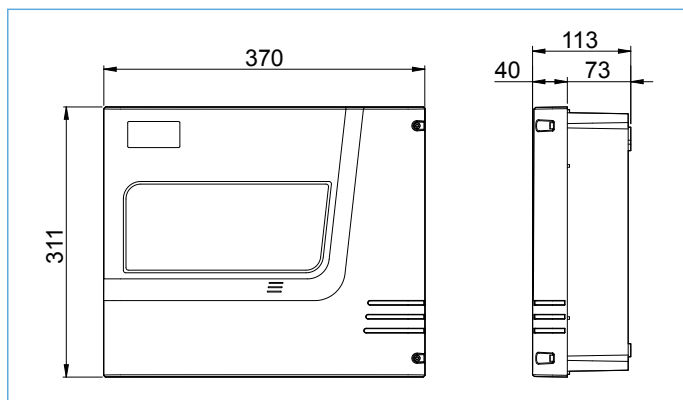







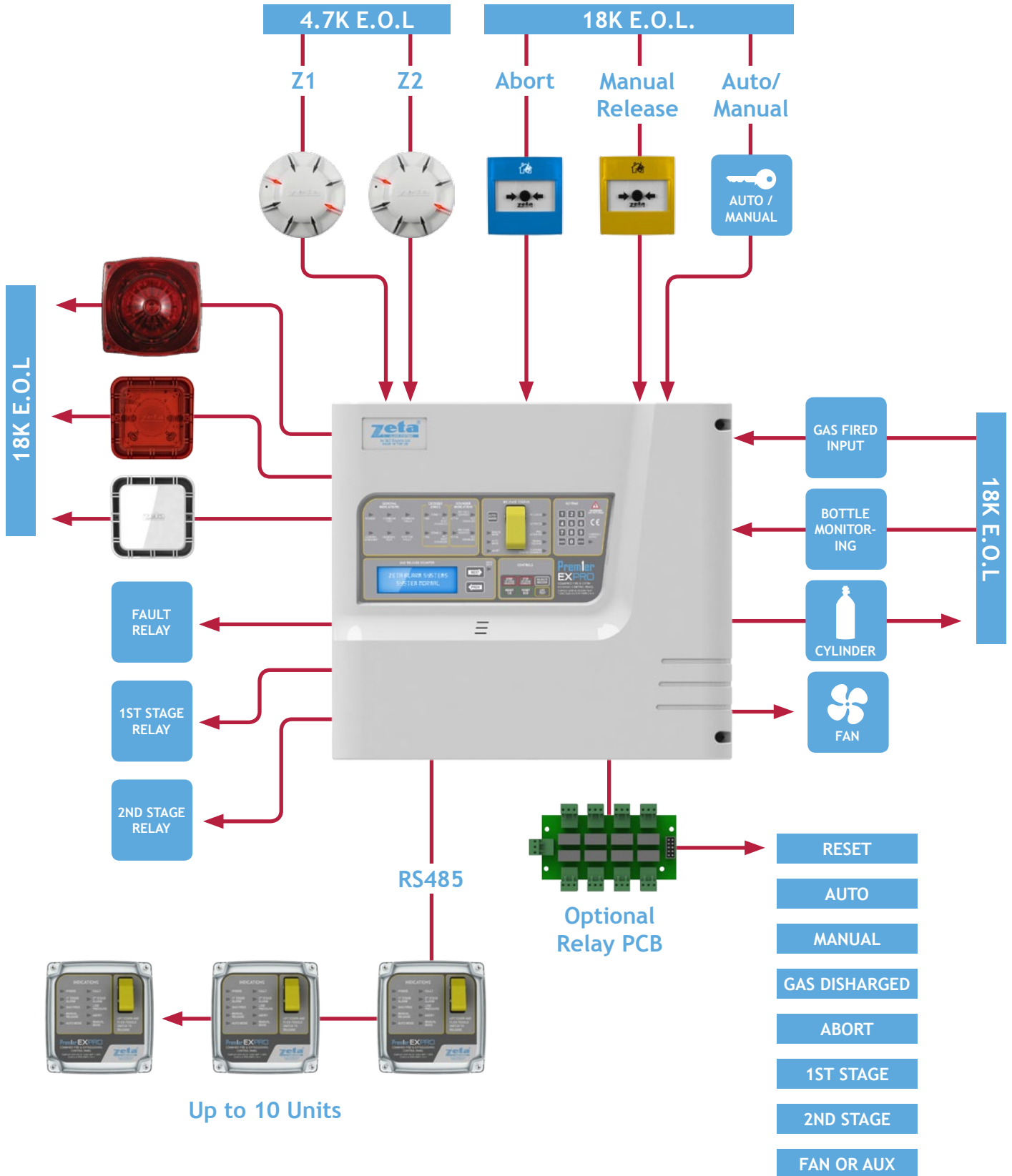





<b>Indications</b>	
4 x 20 LCD	✓
Power	✓
Common Fire	✓
Common Fault	✓
General Disablement	✓
General Test	✓
System Fault	✓
Zonal Fire	✓
Zonal Fault/Test/Disabled	✓
Alarm Active	✓
Alarm Fault/Test/Disabled	✓
Manual Mode	✓
Auto Mode	✓
Abort	✓
Released	✓
Activated	✓
Pre-activated	✓
Manual Release	✓
Flooding Zone Fault	✓
Controls Active	✓
More Data	✓
<b>Control</b>	
Double Action Manual Release	✓
Auto/Manual	✓
Next	✓
Prev	✓
Start 1st Stage Sounders	✓
Stop 1st Stage Sounders	✓
Silence Buzzer	✓
Reset	✓
Reset CIE	✓
LED Test	✓

# Premier EX Pro

## Combined Fire & Extinguishing Control Panel



# Premier EX Pro - Product Range

	Model	Part No.	Description
	EX-PRO	37-096	Premier EX Pro Extinguishing Panel
	EX-RSI	37-098	Premier EX Pro Remote Status Indicator (Repeater)
	EX-OER	37-097	Premier EX Pro Output Expansion Relay PCB
	ZT-CP3/Y	43-630	Gas Extinguishing Call Point
	ZT-CP3/B	43-631	Abort Call Point
	CP3-FMB/Y	43-639	Call Point Flush Mount Bezel
	CP3-FMB/B	43-640	Call Point Flush Mount Bezel
	CP3-CV	43-636	Call Point Protective Cover
	CP3-KEY	43-637	Call Reset Key
	ZT-CP3/WP/Y	43-634	Weatherproof Manual Release Unit (Surface Mount)
	ZMTF/8R	42-032	Maxitone Sounder/Flasher for 1st Stage
	ZMTF/8C	42-032C	Maxitone Sounder/Flasher for 2nd Stage

# Other Zeta Products

25 Years of Manufacturing Excellence



**Simplicity Plus**  
Addressable Fire Alarm System



25 Years of Manufacturing Excellence



**Premier M Plus & Infinity 8**  
Conventional Fire Alarm Systems



25 Years of Manufacturing Excellence



**Premier Quatro**  
Addressable Fire Alarm System



25 Years of Manufacturing Excellence



**INFINITY *iDe***  
The 2 Wire Fire Detection System for Professionals



**Gas Sense**  
Gas Detection System



**Premier EVACS 16**  
Voice Alarm System



Available now from:

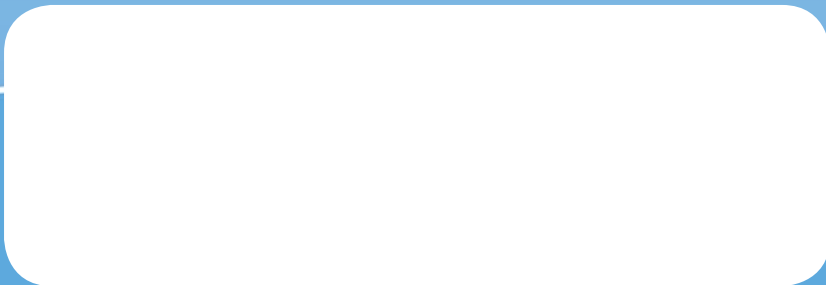

Assessed to ISO 9001: 2008  
Certificate number 330

**GLT Exports Ltd**  
MANUFACTURERS OF FIRE ALARM EQUIPMENT

Tel: +44 (0) 1792 455 175  
Fax: +44 (0) 1792 455 176

Email: [info@zetaalarmsystems.com](mailto:info@zetaalarmsystems.com)  
Web: [www.zetaalarmsystems.com](http://www.zetaalarmsystems.com)

Detection House  
72-78 Morfa Road  
Swansea  
SA1 2EN  
United Kingdom