

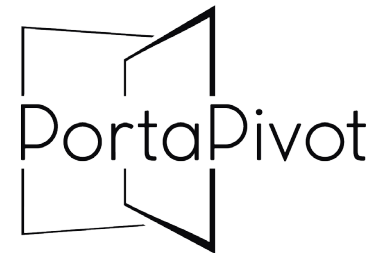

# PortaPivot 6530 XL

## Grid profile placement

Watch our instruction videos on [www.portapivot.com](http://www.portapivot.com)



STEALTHPIVOT  
By PortaPivot

Patented technology

# Delivered parts & recommended tools

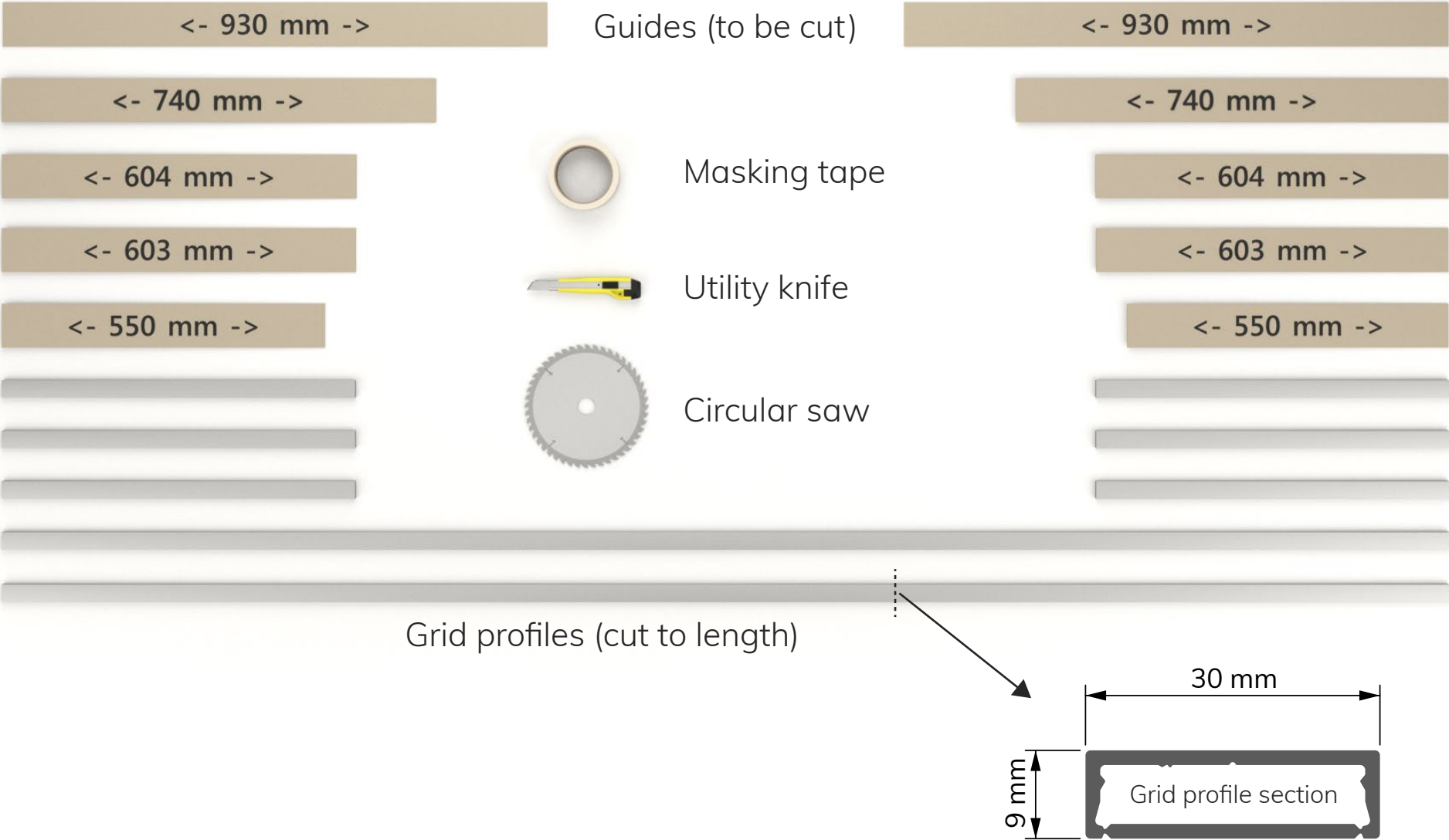

Watch our instruction videos on [www.portapivot.com](http://www.portapivot.com)

Step 1: design your grid pattern

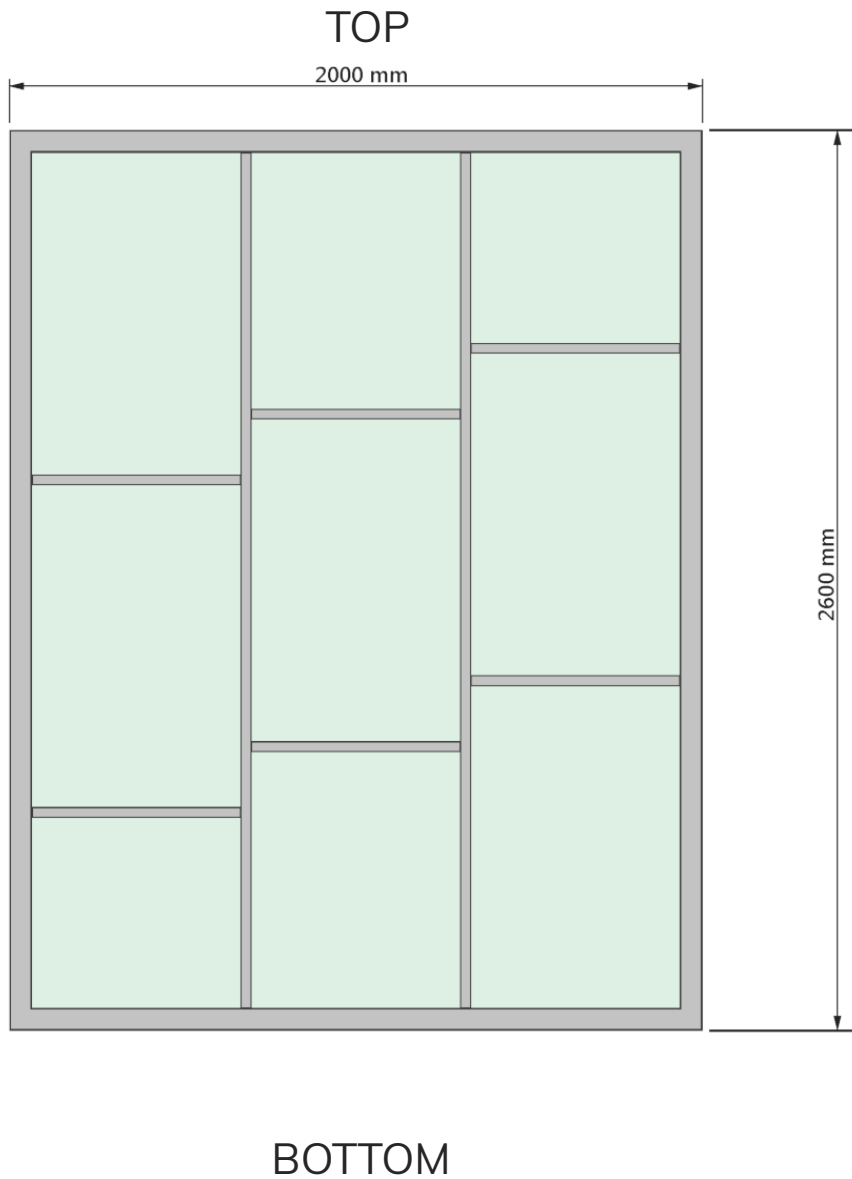

Step 2: calculate grid profile lengths

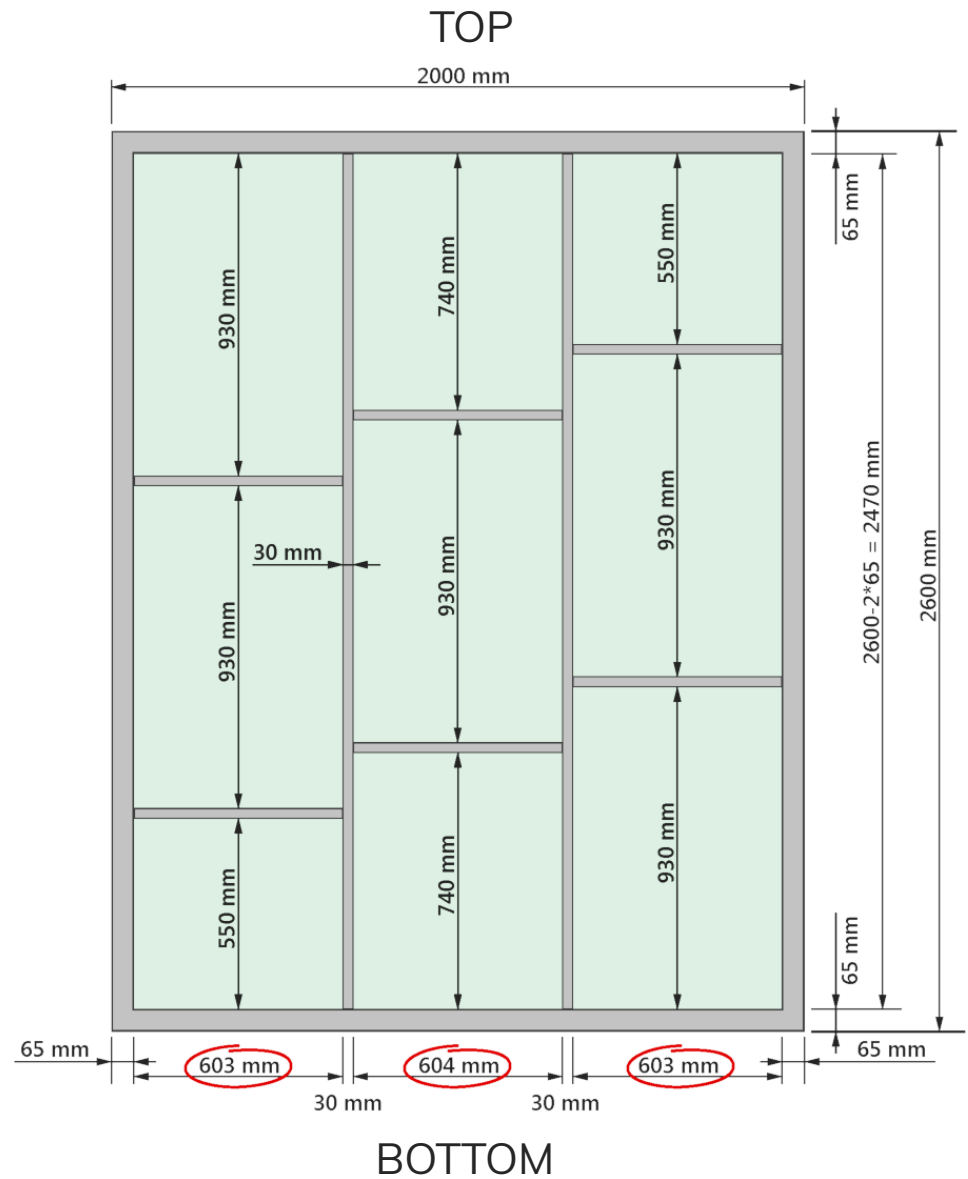

Step 3: remove adhesive tape around cut line

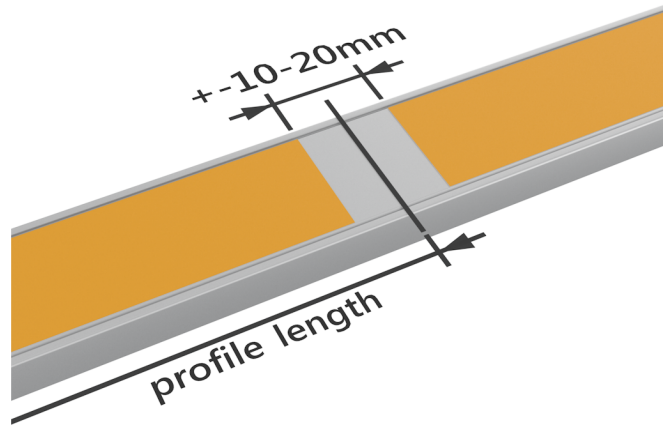

Step 4: cut grid profiles

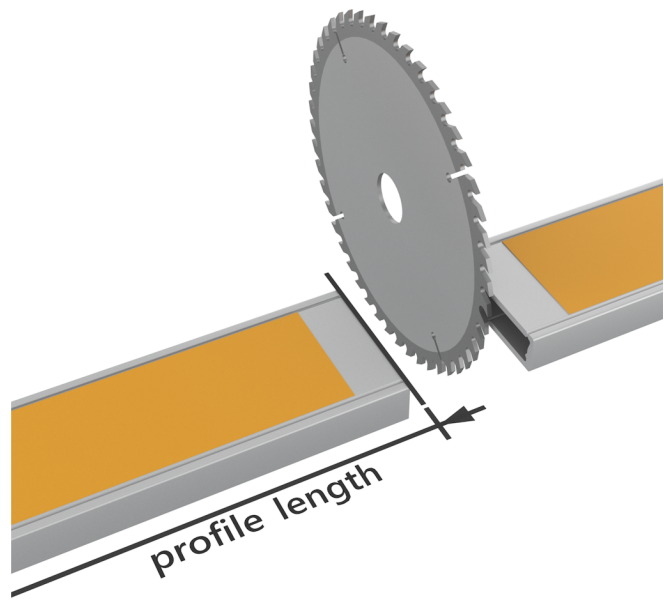

Step 5: calculate guide lengths

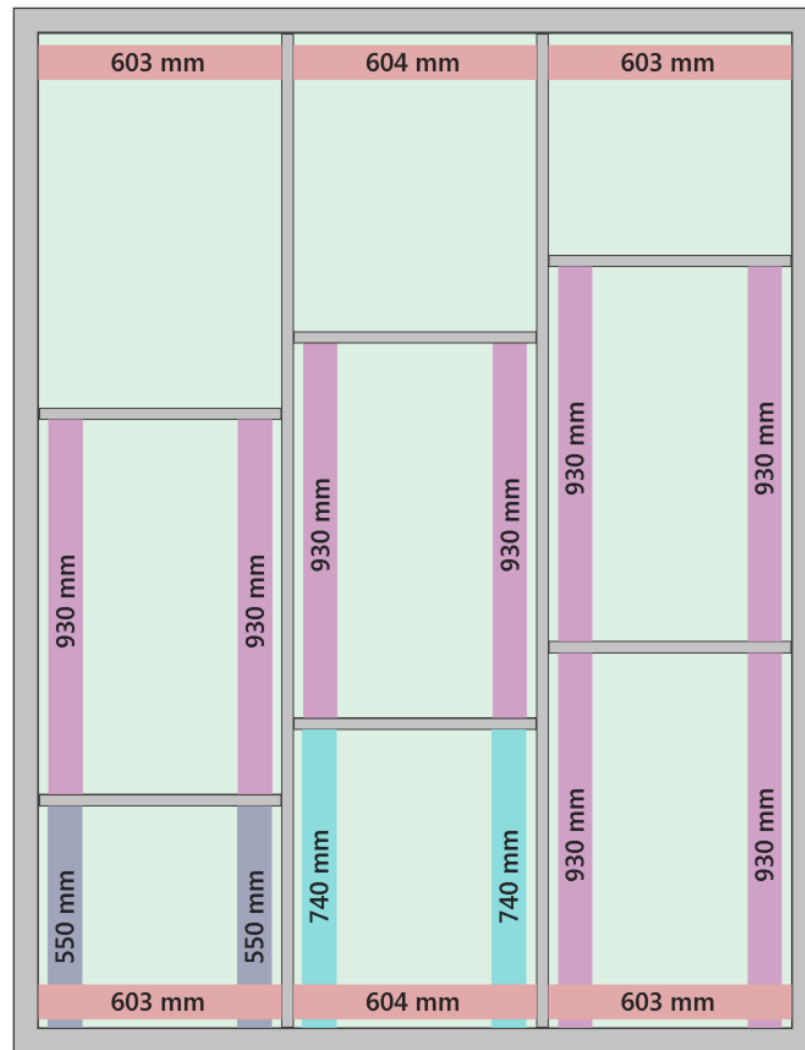

Step 6: cut guides (2 of each length)

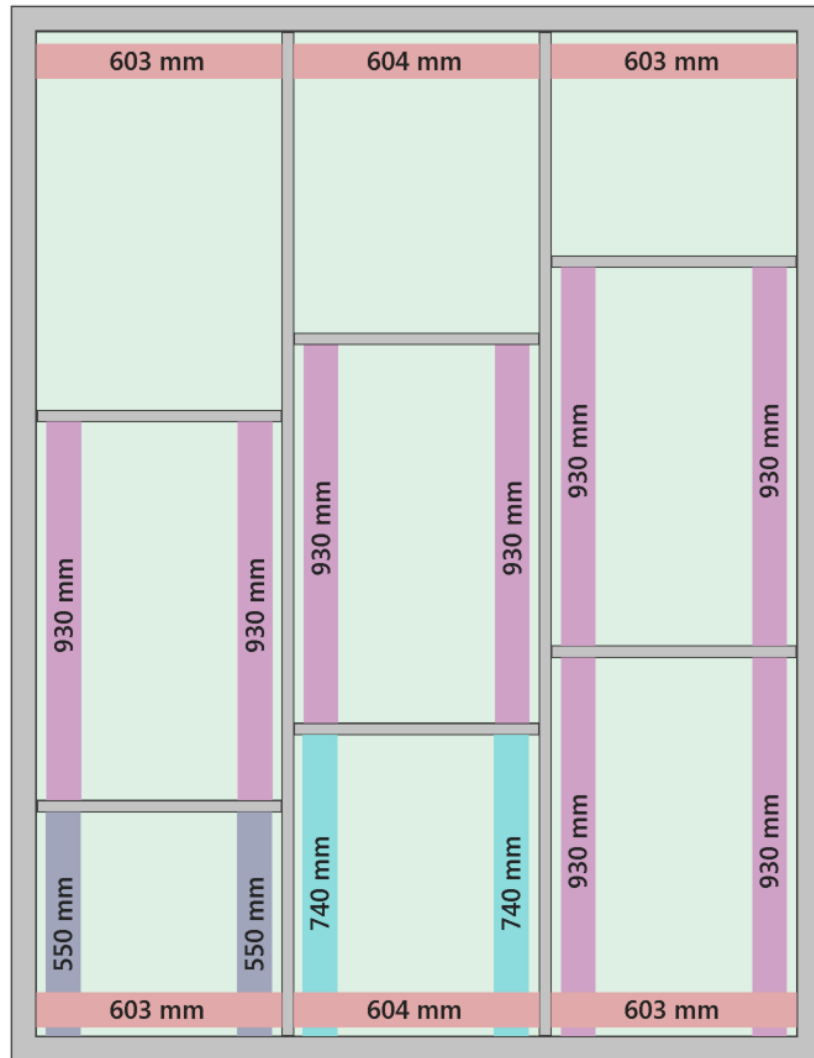

Step 7: degrease panel (preferably with isopropyl alcohol)

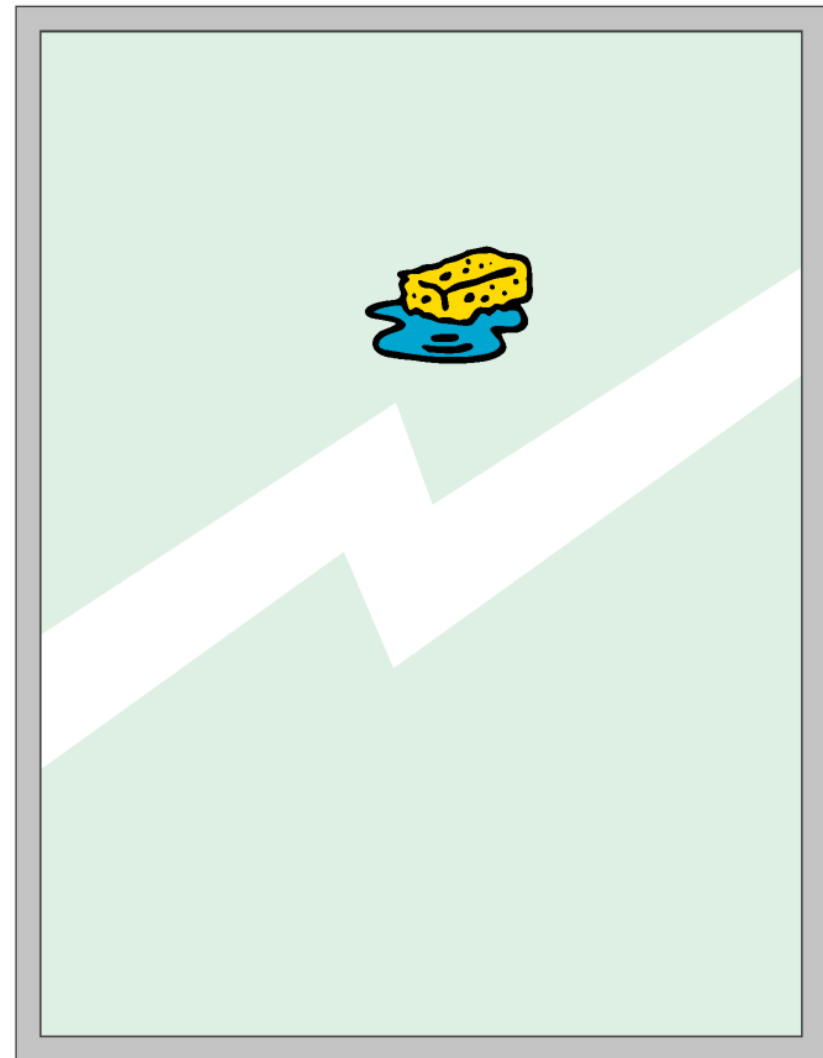

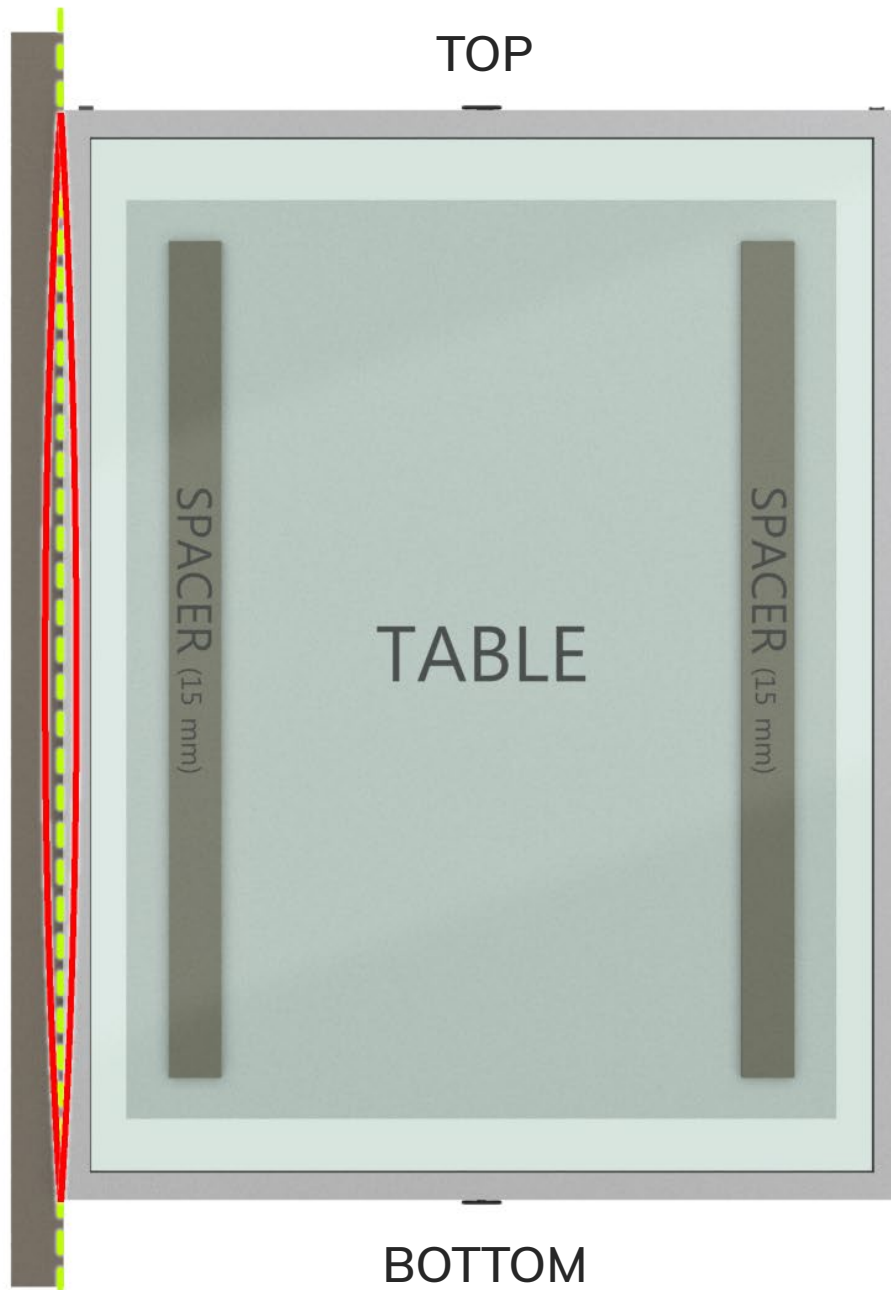

Make sure the starting profile is 100% straight! If not, use a rubber hammer to straighten profile.

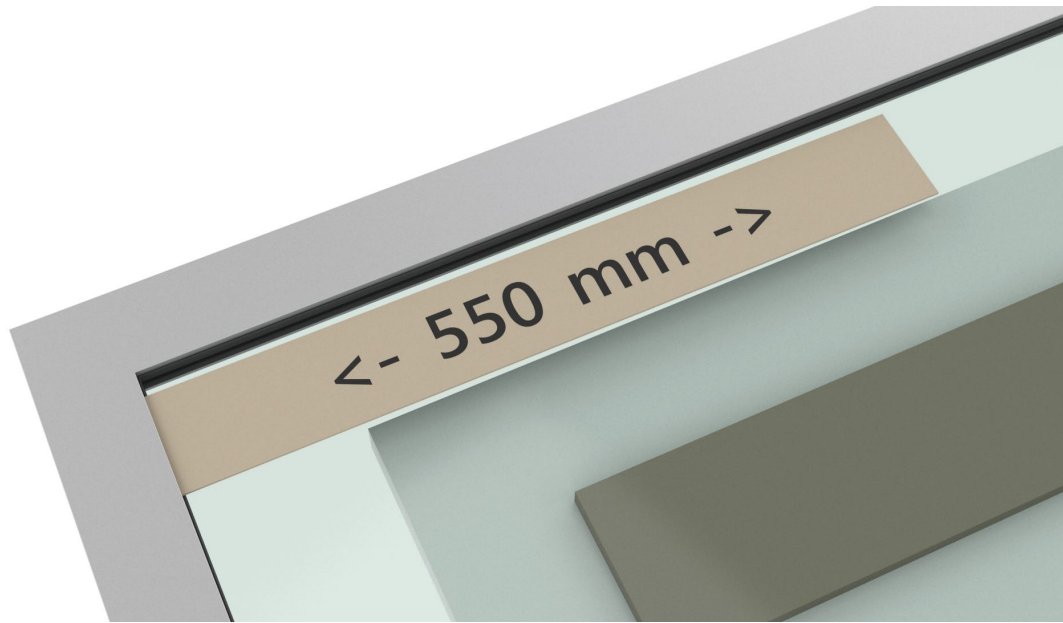

Place the correct length guide in the bottom left corner.

Make sure the guide is placed against the aluminium frame, on top of the rubber.

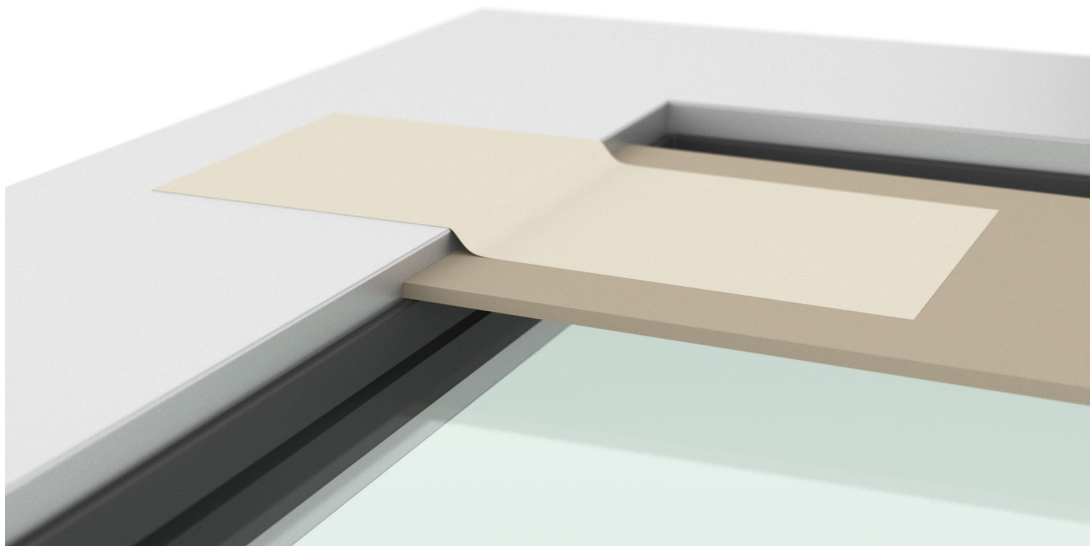
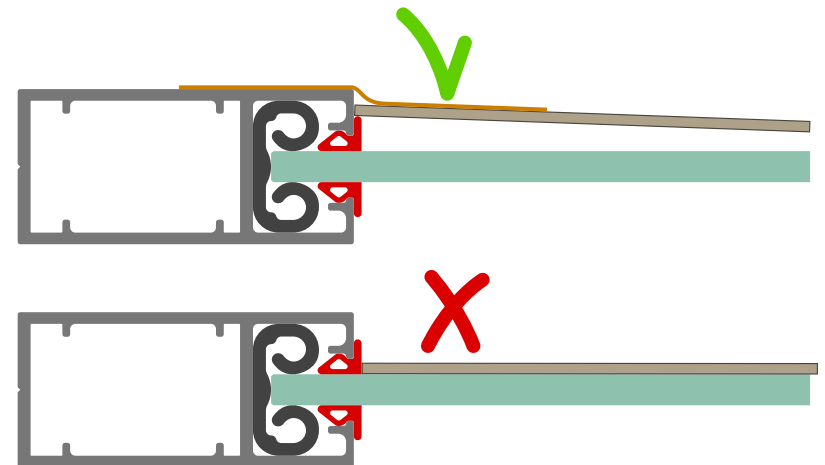

Use masking tape to keep the guide in place, on top of the rubber!.

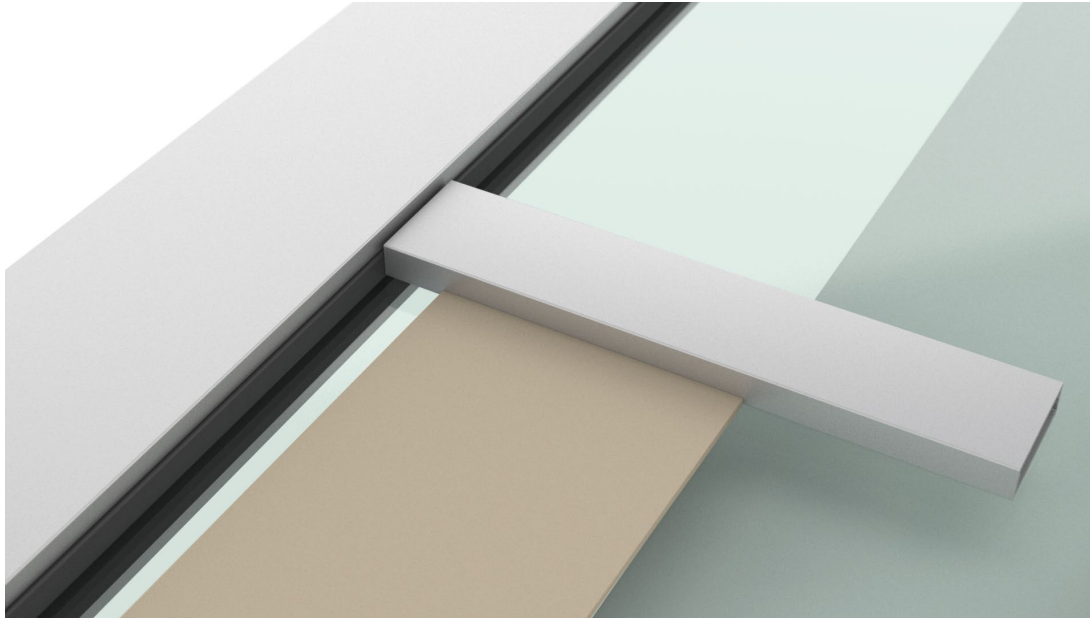

Use a small piece of grid profile as a guide for cutting out a portion of the rubber.

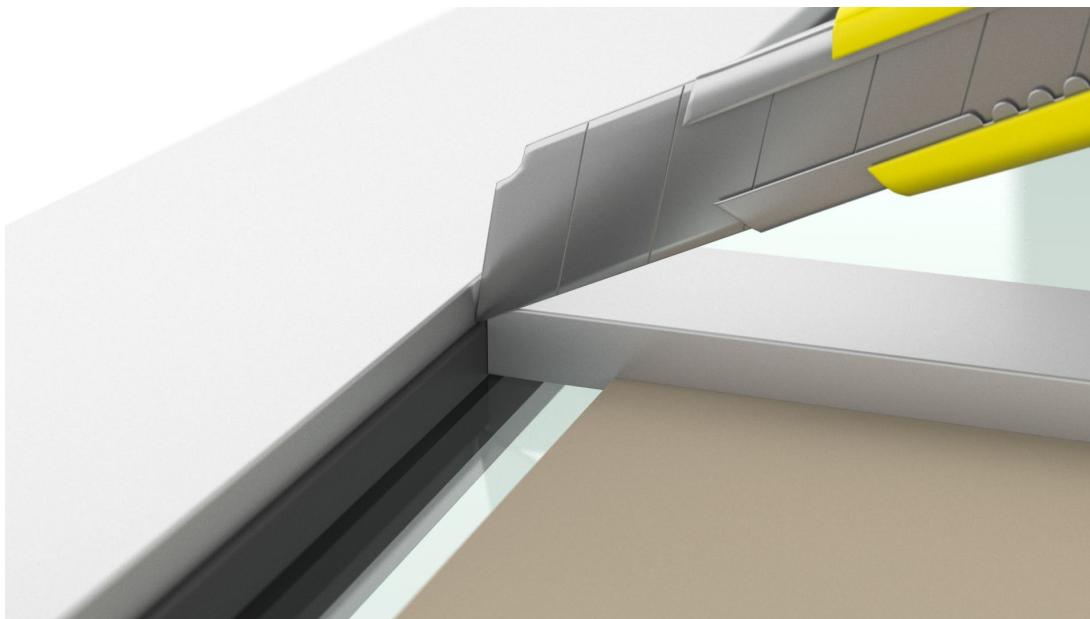

Use a sharp knife and make an incision in the rubber.

**IMPORTANT**

Always cut downwards and away from the frame profile to prevent scratches.



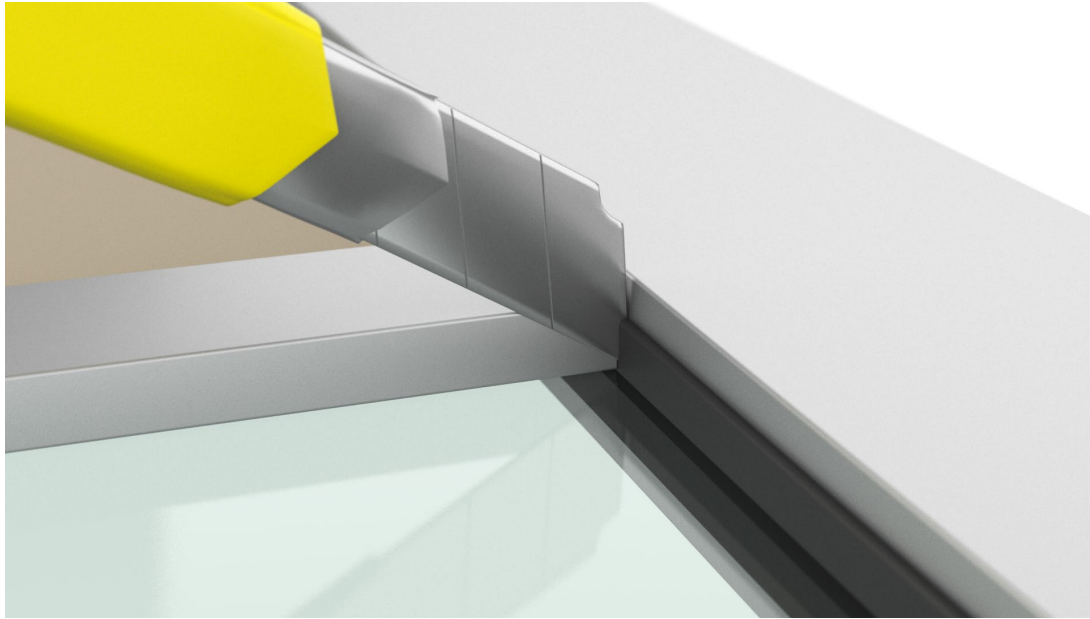

Repeat for the second incision.

Cut along the side of the frame profile and remove the rubber piece.

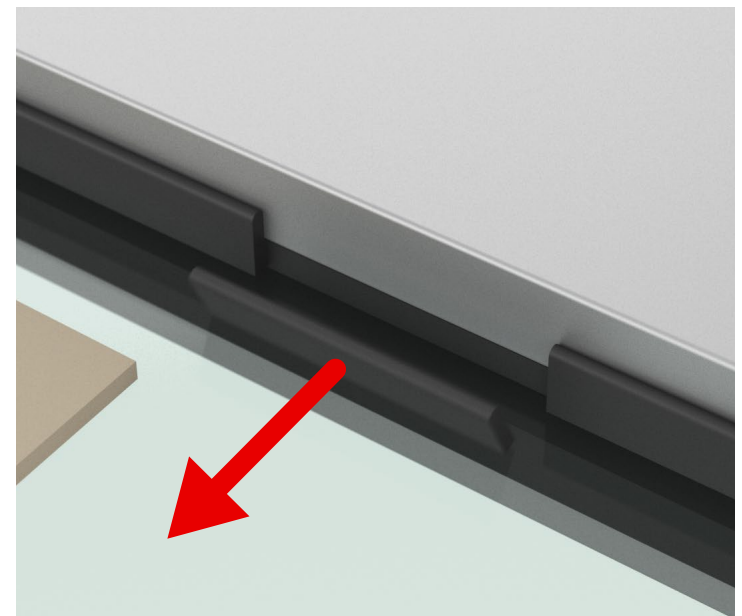
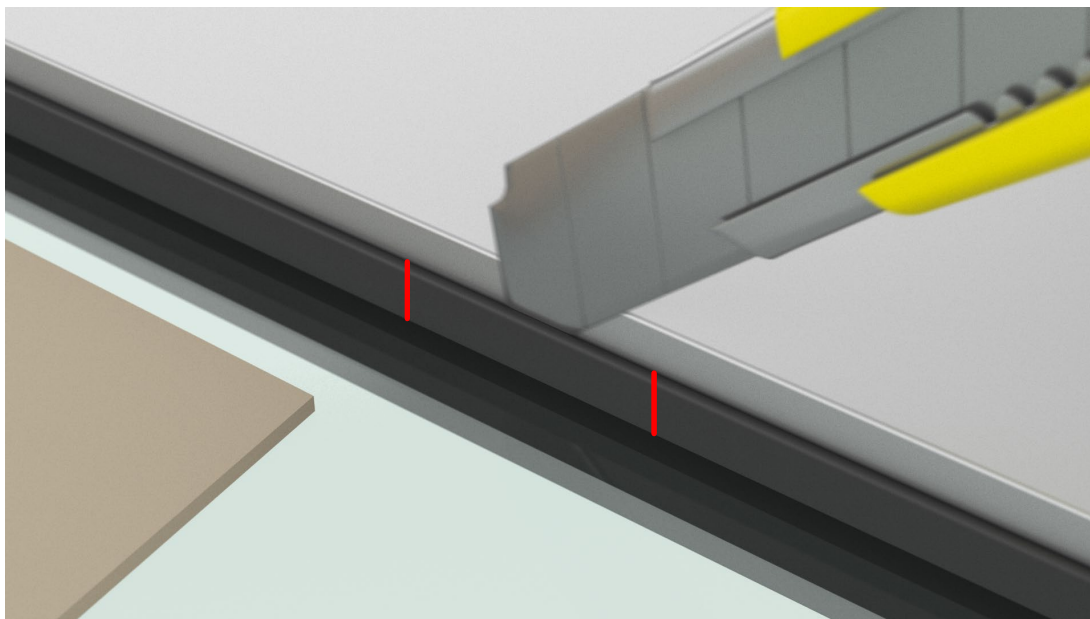

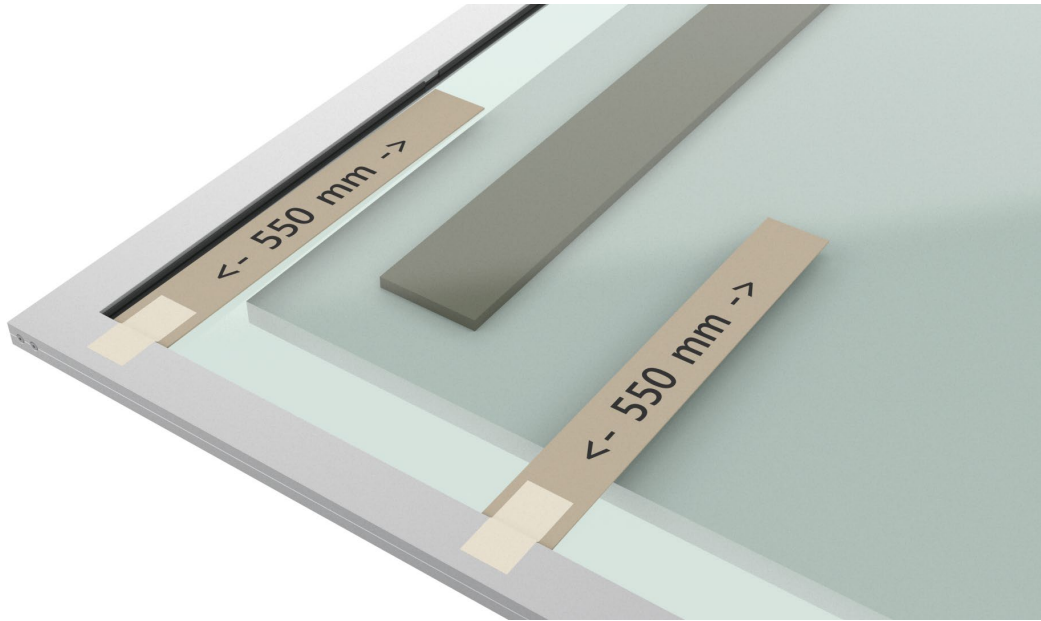

Place a second length guide

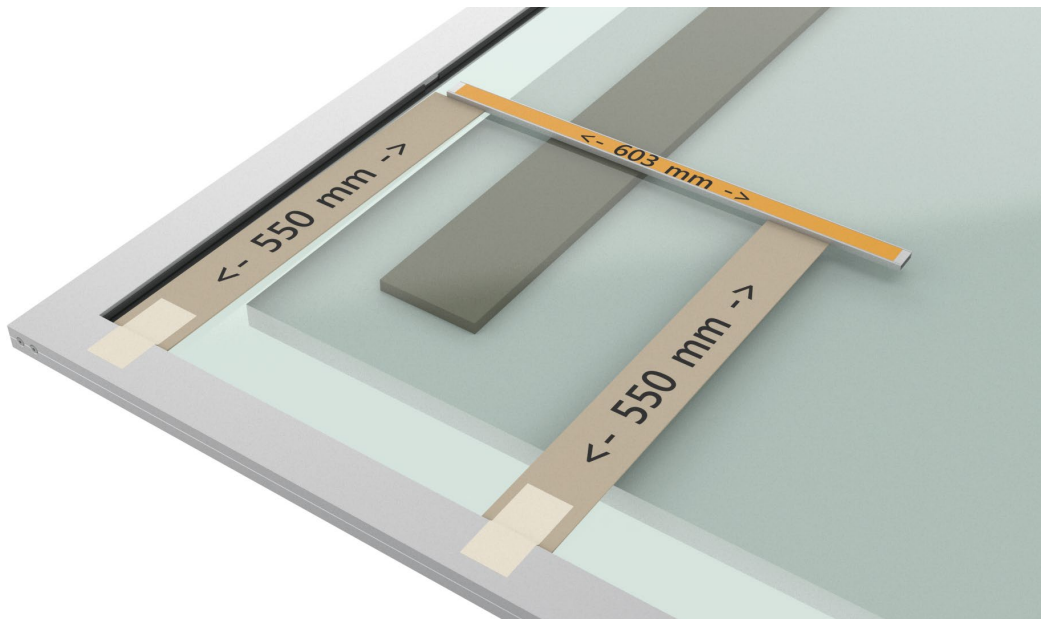

Take the first grid profile (603 mm)

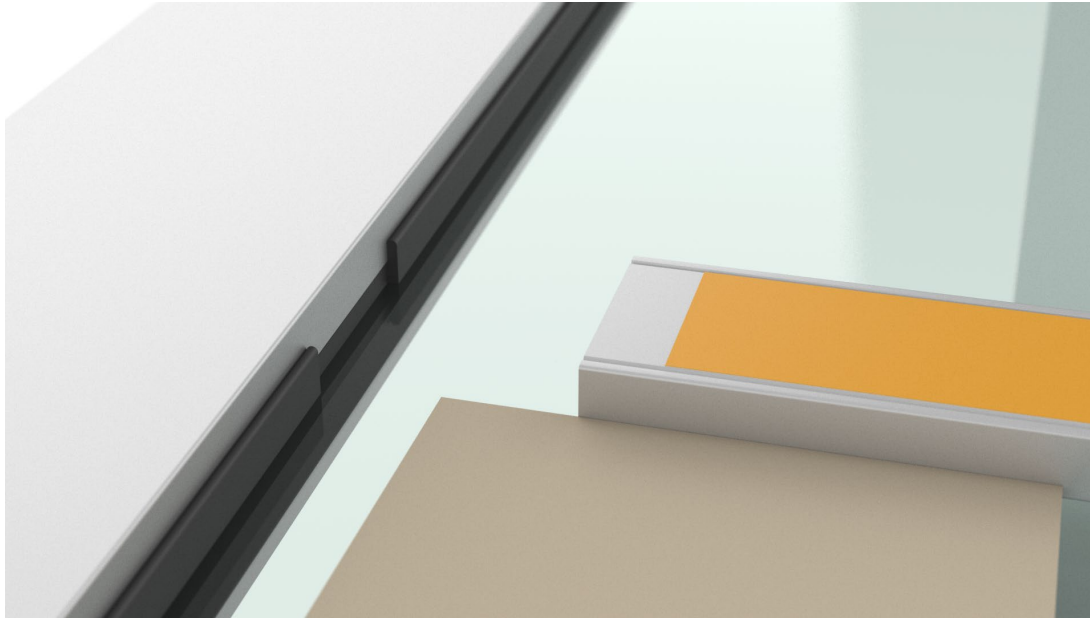

A small portion of tape should have been removed before the grid profile was cut. This will facilitate positioning.

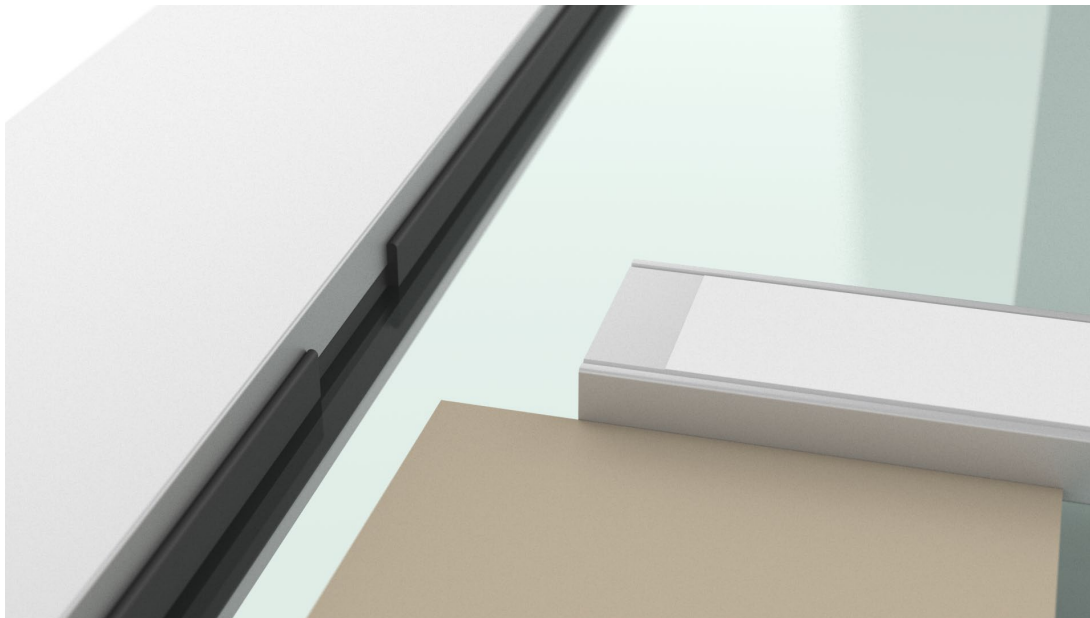

Remove the backing strip.

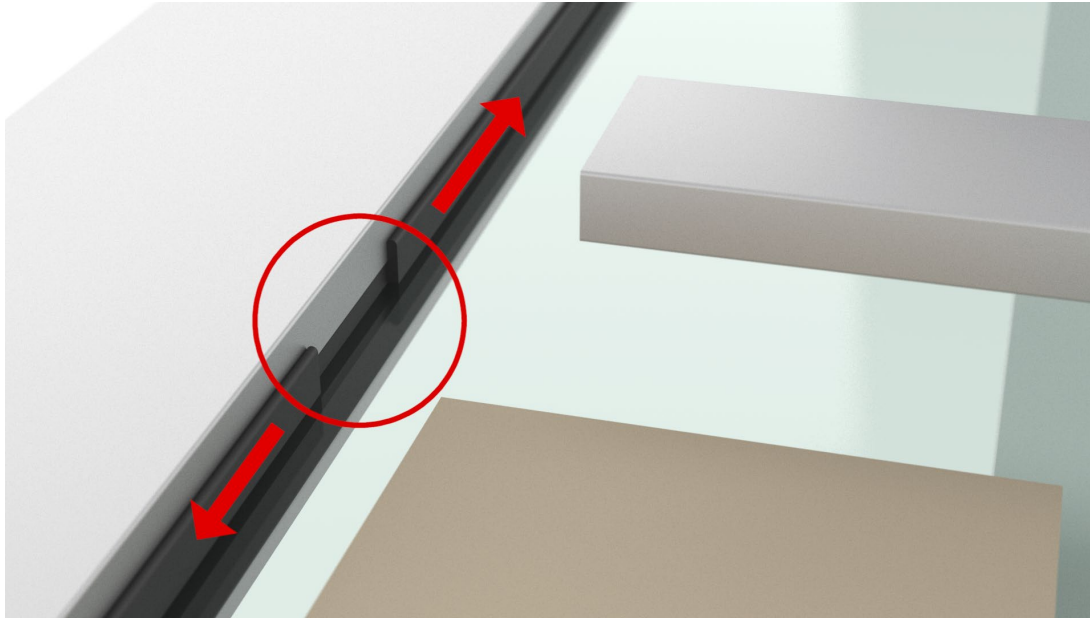

If necessary, widen the gap in the rubber a little bit by sliding each side with your hands.

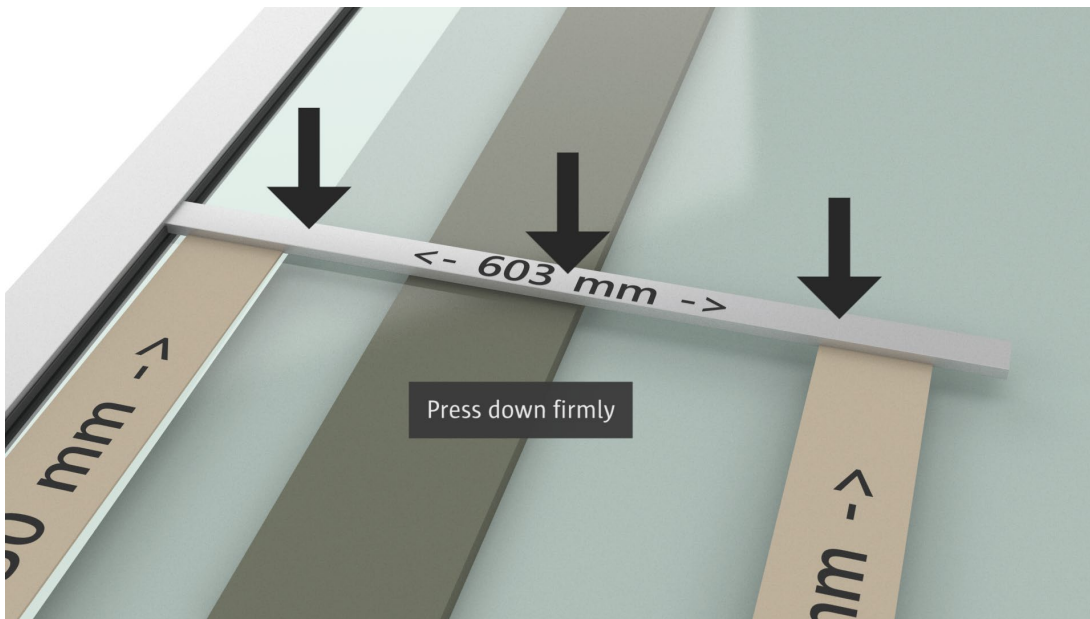

Place one end of the grid profile in the rubber gap, use the length guides to position it onto the glass and press down firmly.

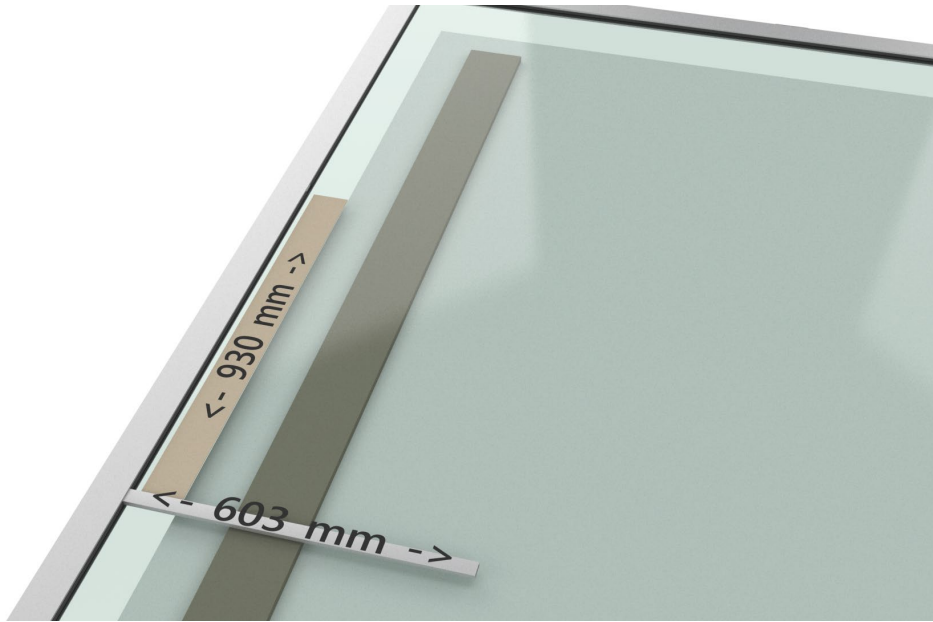

Repeat the same steps for the second grid profile.

Step 1: Place length guide

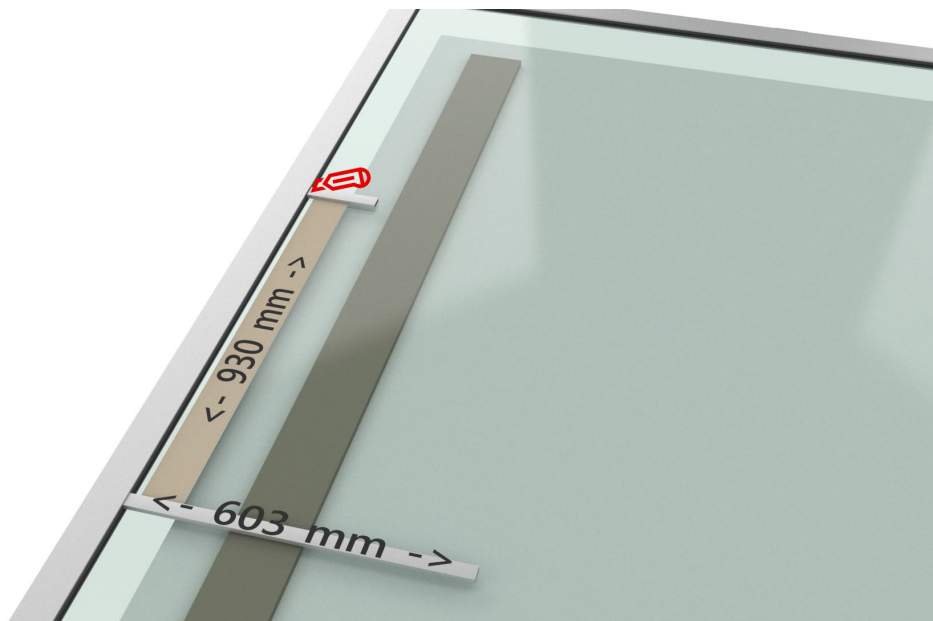

Step 2: Cut rubber with grid profile guide

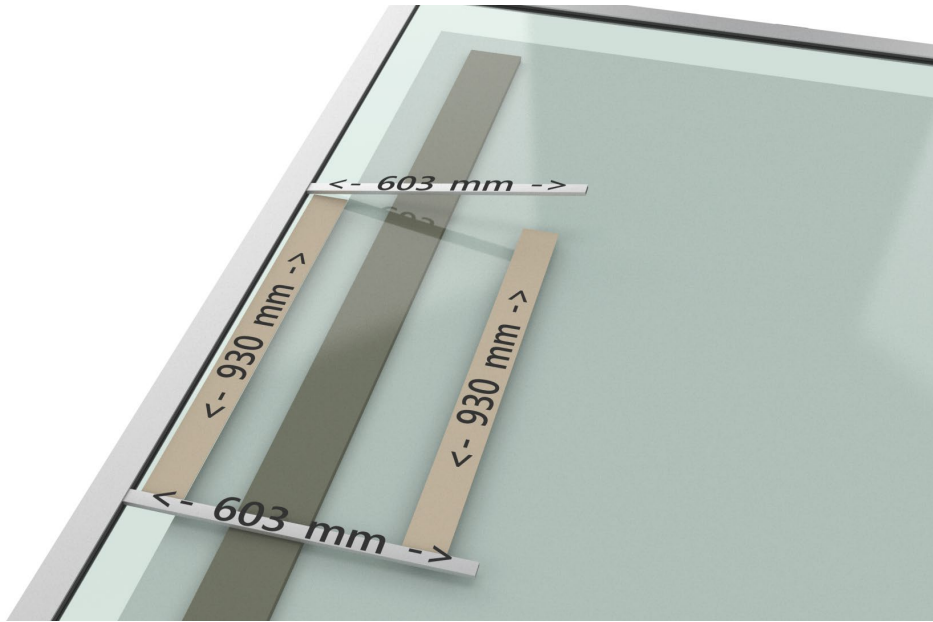

Step 3: Place second length guide

Step 4: Place profile

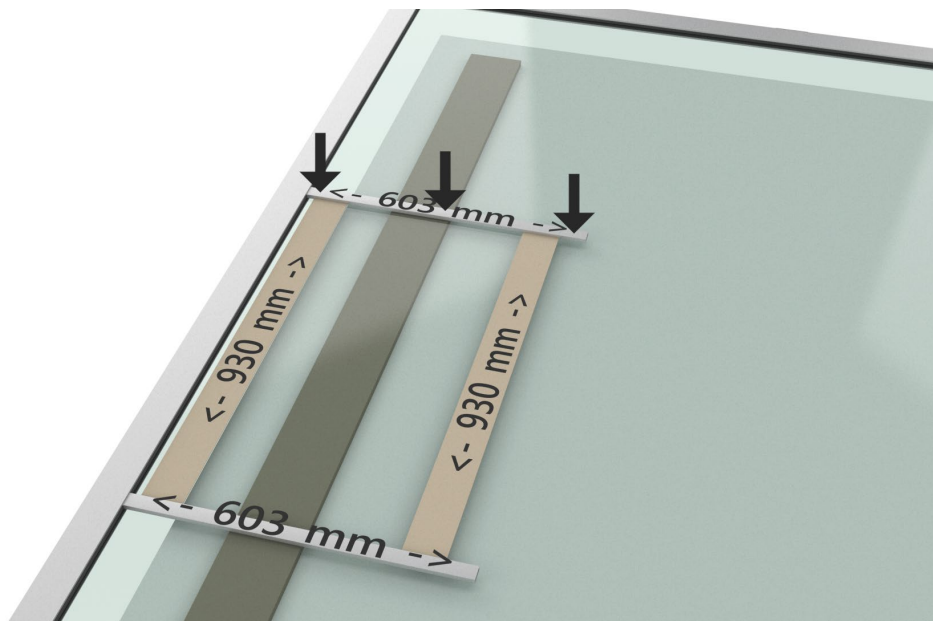

Step 5: Press down firmly

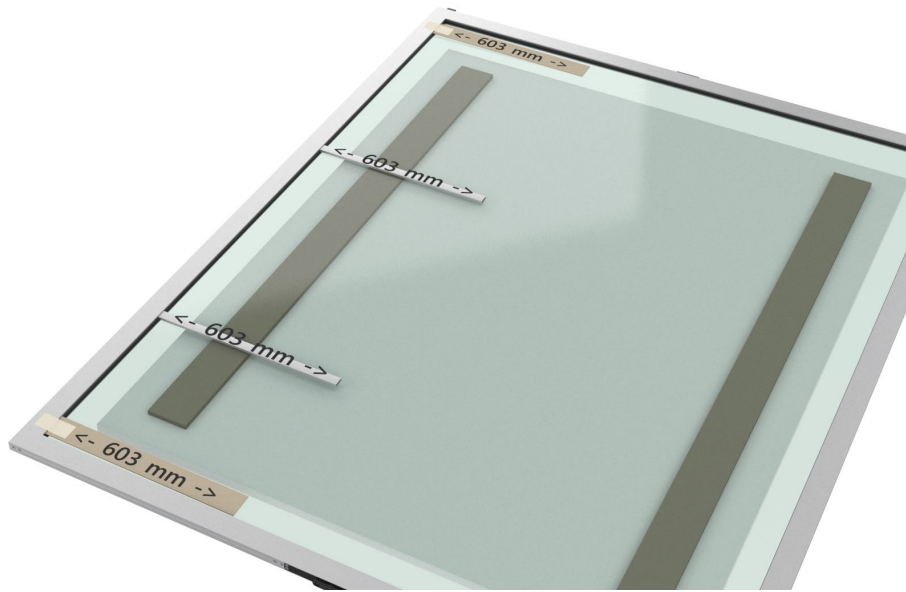

Repeat the same steps for the first vertical grid profile.

Step 1: Place length guides

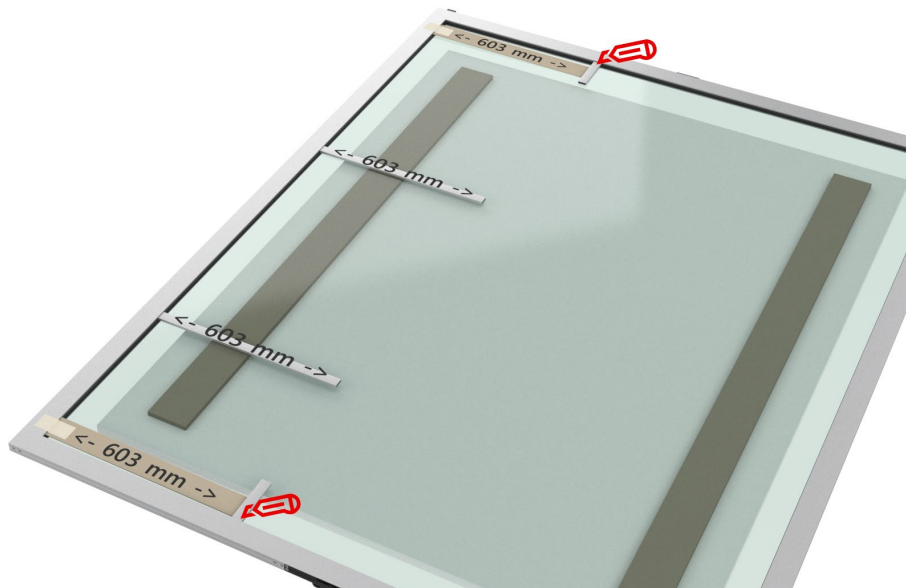

Step 2: Cut rubber with profile guide

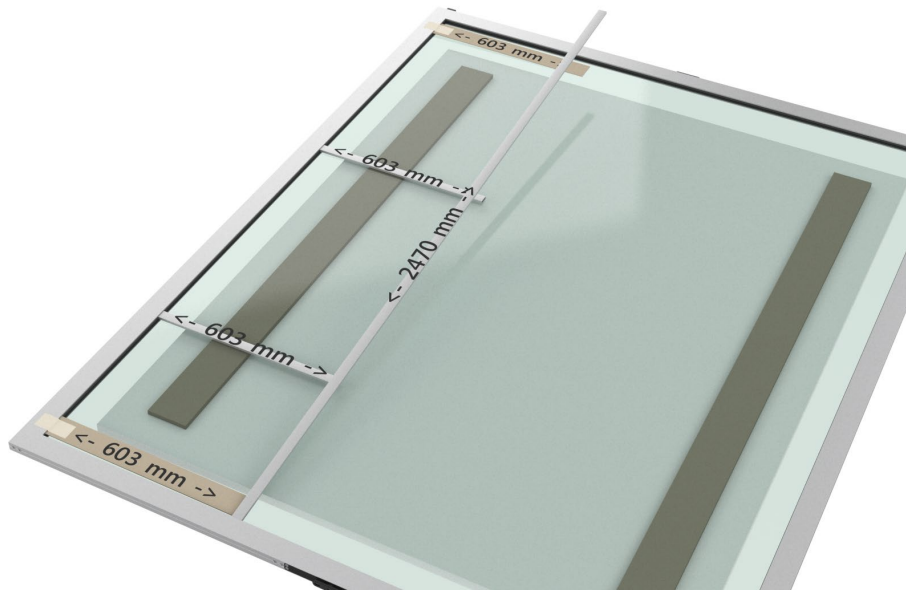

Step 3: Place vertical grid profile

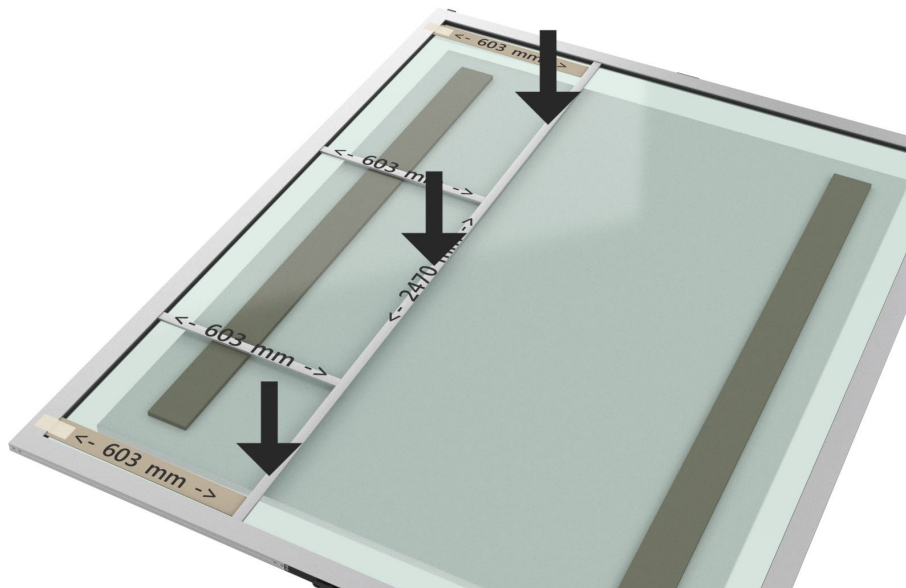

Step 4: Press down firmly



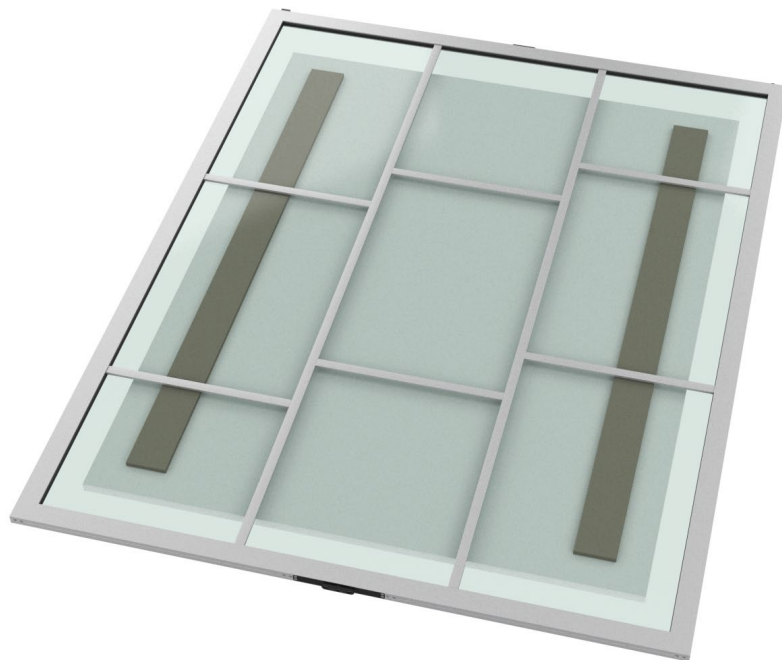

Repeat steps for all remaining grid profiles, using the correct length guides and grid profiles (according to your design).

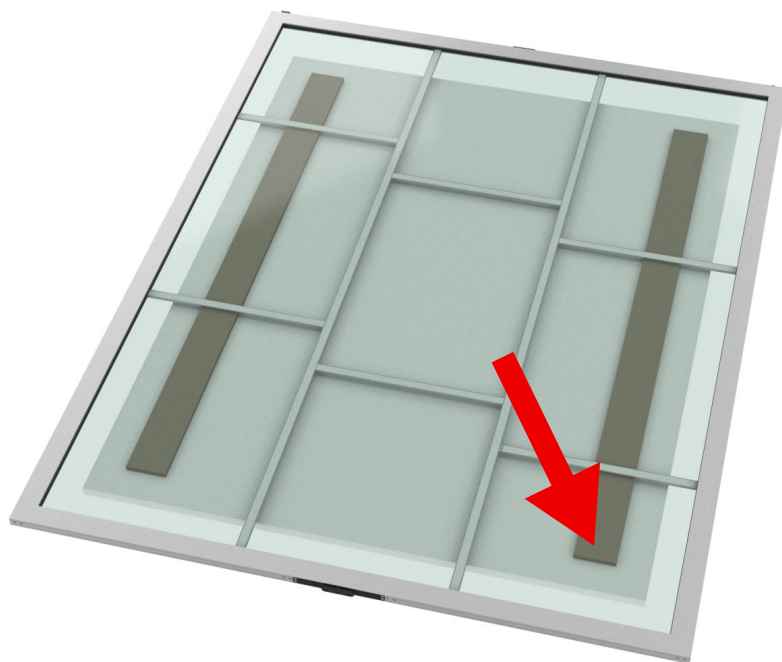

Flip over the door leaf and repeat all steps for the counterside.

For perfect alignment, start assembly in the same corner as the first side.

For further instructions on how to install  
the fully assembled door in your doorway,  
please refer to the DOOR INSTALLATION MANUAL

All manuals are also available in video format on [www.portapivot.com](http://www.portapivot.com)