



How to stay alive in V4? Phosphorus Friends Club builds V4's resilience

Portfolio of Phosphorus Friends in Europe

Authors:



Mineral and Energy
Economy Research
Institute
Polish Academy of Sciences

Marzena SMOL
Paulina MARCINEK
Dominika SZOŁDROWSKA



WARSAW
UNIVERSITY
OF LIFE SCIENCES

Eugeniusz KODA
Anna PODLASEK



Milan HEMZAL
Jiří Jaromír KLEMEŠ



Bay Zoltán
Nonprofit Ltd.
for Applied Research

Kinga LORENCZ
Péter CHRABÁK
Katalin KURUCZ



TECHNICAL UNIVERSITY
OF KOŠICE

Zuzana ŠIMKOVÁ
Tomáš BAKALÁR
Henrieta PAVOLOVÁ
Tomáš PAVLIK
Juraj JANOČKO
Martin SISOL

December, 2021



WARSAW
UNIVERSITY
OF LIFE SCIENCES



Bay Zoltán
Nonprofit Ltd.
for Applied Research



TECHNICAL UNIVERSITY
OF KOŠICE

www.phosv4.eu



Content

1. Phosphorus in the environment – general information	3
2. Information about importance of phosphorus raw materials in the securing the supply of the food in V4 in the face of pandemic	4
3. Phosphorus raw materials flow in Visegrad Group	5
3.1. Poland	5
3.1.1. Introduction and framework	5
3.1.2. Phosphorus raw materials in Poland	7
3.1.3. Use of phosphorus raw materials in food sector in Poland	12
3.1.4. Stakeholders involved in the flow of phosphorus raw materials in Poland	19
References	21
3.2. Czech Republic	26
3.2.1. Introduction and framework	26
3.2.2. Phosphorus raw materials in Czech Republic	26
3.2.3. Stakeholders involved in the flow of phosphorus raw materials in Czech Republic	28
3.2.4. Phosphorus and our health	33
References	34
3.3. Hungary	35
3.3.1. Introduction and framework	35
3.3.2. Phosphorus raw materials in Hungary	36
3.3.3. Use of phosphorus raw materials in food sector in Hungary	37
3.3.4. Stakeholders involved in the flow of phosphorus raw materials in Hungary	43
References	46
3.4. Slovakia	47
3.4.1. Introduction and framework	47
3.4.2. Phosphorus raw materials in Slovakia	48
3.4.3. Use of phosphorus raw materials in food sector in Slovakia	59
3.4.4. Stakeholders involved in the flow of P raw materials in Slovakia	61
References	62
4. Conclusion	63

The project is co-financed by the Governments of the Czechia, Hungary, Poland and Slovakia through Visegrad Grants from International Visegrad Fund. The mission of the fund is to advance ideas for sustainable regional cooperation in Central Europe.

supported by
• Visegrad Fund
•

1. Phosphorus in the environment – general information

Phosphorus (P) is a chemical element with an atomic number of 15 and an atomic mass of 30.974. P has no metallic properties. For this reason, it is classified as flu of non-metals. Detailed characteristics of P are presented in **Table 1**.

Table 1. Characteristics of P

Symbol	P
Name in English	phosphorus
Name in Latin	phosphorus
Atomic Number	15
Atomic Weight (u)	30.973762
Element Classification	Non-Metal
State at 20°C	Solid
Melting point	44.15°C, 111.47°F, 317.3 K (white phosphorus)
Boiling point	280.5°C, 536.9°F, 553.7 K (white phosphorus)
Density (g/cc):	1.82 (white phosphorus) at 20 °C (68 °F)
Oxidation states	-3, +3, +5
Electron Configuration	1s ² 2s ² 2p ⁶ 3s ² 3p ³
Pauling Negativity Number	2.19
Atomic Radius (pm)	128
Atomic Volume (cc/mol)	17.0
Key isotopes	³¹ P
CAS Registry Number	7723-14-0

Source: [1,2]

In nature, P occurs in four allotropic varieties:

- white,
- red,
- purple,
- black.

White P was discovered by the German alchemist Henning Brand in 1669 in Hamburg. The scientist evaporated animal urine and roasted the remains of the substance with the addition of sand, without air access. During the process, a white waxy substance was formed on the inside walls of the laboratory vessel. Thus, white P was obtained [3]. Its properties are used in the production of incendiary weapons (flammability) and rat poison (poisonous nature).

Red P is produced in the process of white P roasting at a temperature of 250 ° C, in a nitrogen atmosphere with the addition of iodine, which acts as a catalyst. Unlike white P, it is less reactive and non-toxic. It is used for the production of matchboxes.



Another allotropic variety of P is purple P, which was invented by the German chemist and physicist Johann Wilhelm Hittorf [4]. Purple P was obtained in 1865 by heating red P at a temperature of about 550°C without oxygen (in a vacuum). Purple P can also be obtained by crystallization from a solution of white P in molten lead [5]. The main features of purple P are solubility and low chemical activity.

Black P is the most stable type of P obtained during the process of heating white P or red P at a temperature higher than 200°C in a vacuum, under a pressure of 12,000 physical atmospheres [4]. The discoverer of black P was the American Nobel Prize winner Percy Williams Bridgman. An interesting property of black P is its current conductivity.

P is the basic nutrient responsible for the growth of all living organisms with properties that cannot be substituted [6]. Moreover, P is the third major component (after potash and nitrogen) used in industrial fertilizers. In the results, P represents a crucial element of the food security system. As a result, P represents a critical element of the food security system [7].

2. Information about importance of phosphorus raw materials in the securing the supply of the food in V4 in the face of pandemic

Currently, COVID pandemic is the greatest threat of modern economies. The V4 countries were the first in EU to introduce restrictions to prevent the spread of virus, which proves their great responsibility for residents. Citizens stayed home, and the only thing they needed to survive was food. It showed that the greatest challenge is to ensure people's safety and access to food - it requires the provision of raw materials for food production.

The most important raw material needed for the food production is P which cannot be replaced by other element. It is listed as Critical Raw Materials [8,9]. It is an element essential for human nutrition or used for fertilizer production. The key importance of P for people's lives is shown by the fact that if there was no sufficient amount of P in fertilizers, we would be able to exploit only 1/3 of the world's population. Unfortunately, in V4 countries, there is lack of a mineral deposits of phosphate rock, therefore we need to cover the demand for the P by import from countries of varying stability, both economic and political as Russia, China or Morocco. It is risky, if the borders for deliveries of goods are closed, it may be impossible to meet the needs of P. On the other hand, V4 countries have large secondary P resources in P-rich waste, which are lost due to P is not recovered and directed to fertilizers.

Sustainable management of P is crucial for agriculture, food, water and the environment. Strategically, Europe should be independent in supply of P, and therefore,



there is a significant need to recover P from P-rich residues, as wastewater and sewage sludge. Developed countries were already taken actions in this field, where P recovery is obligatory, thus achieving P security in domestic economy. Unfortunately, in V4 countries, P use involves losses at every stage in its lifecycle for the reason of the lack of knowledge of amount and recovery potential of P-rich waste sources, know-how, lack of action plan, financial resources or low awareness on P importance for people's lives. For this reason, the sustainable management of P and other actions are important to ensure that there is sufficient P for food production.

3. Phosphorus raw materials flow in Visegrad Group

3.1. Poland

3.1.1. Introduction and framework

The natural cycle of P covers the atmosphere to a small extent and is mainly limited to aquatic and terrestrial ecosystems [10]. Therefore, it is indicated that in the natural cycle of P, transport by surface waters to water reservoirs is of decisive importance. The content of dissolved phosphates in surface waters is low. Most of the P is transported as colloidal particles or as a suspension. The natural cycle of the P is shown in **Figure 1**. A selected proportion of P compounds can be taken up from the soil or surface waters by plants and then by animals. As a result of plant death, mineral and organic P compounds are deposited again in the soil and bottom sediments. The same is the case with the uneaten food components, excreted in the form of feces, as well as with carrion [11].

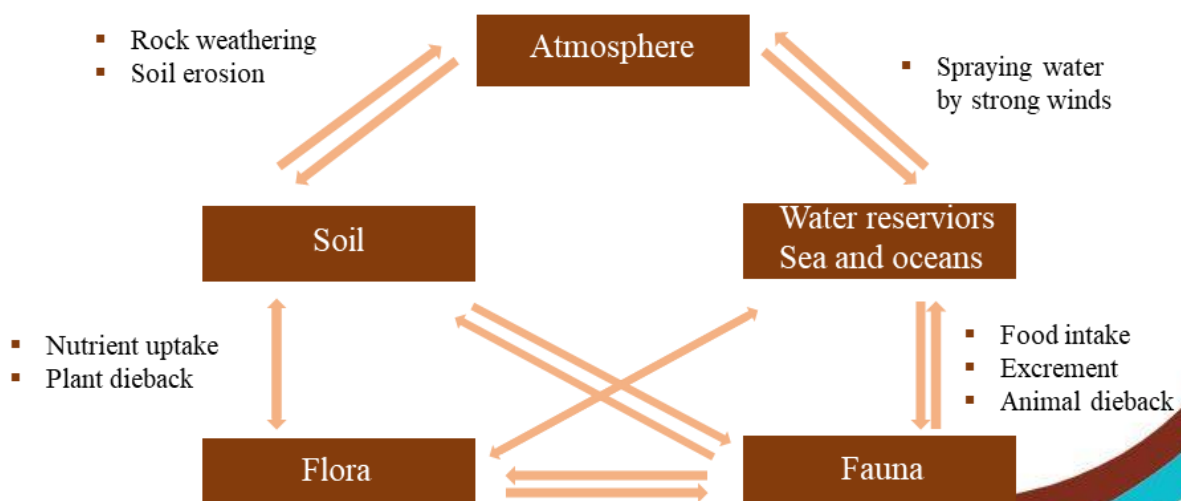

Figure 1. Natural cycle of P
Source: [11]

Microorganisms are of vital importance for the movement of P. As a result of both aerobic and anaerobic processes, they can release phosphates from sparingly soluble compounds. Under favorable conditions, as a result of these processes, the content of P in the water may increase to the eutrophic level.

In recent decades, the geochemical cycle of P has been significantly disrupted by human activity. Population growth, urbanization and industrial development contributed to the increase in the amount of pollutants. It also influenced the increase in the demand for P compounds, increasing the consumption of natural P raw materials, currently considered the most accessible source of P [11] Therefore, the flow diagram of P in nature should also take into account this kind of anthropogenic influence, as shown in **Figure 2**.

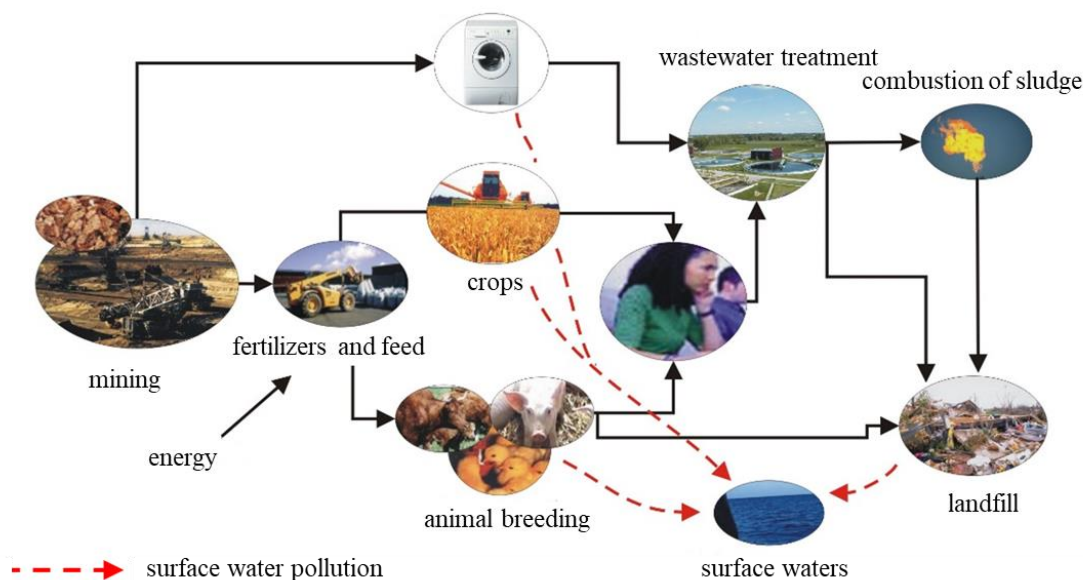

Figure 2. P in the anthropogenic cycle
Source: [12]

P compounds from anthropogenic sources have a significant impact on the environment, including air, soil and water reservoirs. The most noticeable impact on the environment concerns mainly the water environment [12]. Although the emission of dust during the extraction of P raw materials from the chemical industry and from waste neutralization and storage plants has a negative impact on the local level of air dust, it does not play a significant role in the P balance in nature. The increase in the P level in the soil is mainly related to the intensification of the fertilization of crops. Phosphate ions, derived from artificial mineral fertilizers, easily react with metals contained in the soil [13]. As a result, sparingly soluble phosphates are formed. The calcium, iron and aluminum ions are mainly responsible for the immobilization of P in the soil.



The use of fertilizers containing P in organic compounds, e.g. in manure, may increase the concentration of P in groundwater. For this reason, the use of manure in plant crops should be carried out in a controlled manner. It is particularly important to control the balance of nitrogen and P introduced into the soil with manure [11]. However, it should be clearly emphasized that water reservoirs are the most exposed to an uncontrolled increase in the content of nutrients (including P and nitrogen). The most important sources of P in surface waters are municipal and industrial wastewater, leached fertilizers from farmland, soil erosion and deforestation.

Analysis of the P cycle led to the conclusion that the P balance in nature was disturbed by human activity. Anthropological sources cause an increase in the amount of P in the natural cycle. Therefore, it becomes necessary to limit the flux of P compounds released to the environment as a result of human activity.

3.1.2. Phosphorus raw materials in Poland

Primary sources of phosphorus

In Poland, phosphorites occur at the north-eastern margin of the Holy Cross Mts. (vicinities of Radom-Iłża-Annopol-Gościeradów-Modliborzyce) in the form of calcium phosphate-rich nodules in the various types of sediment [14].

The exploitation of phosphate phosphorites began in the country between the First and the Second World War. Currently, due to economic aspects, no deposits are exploited. The last exploited phosphorite deposit, located in Chałupki, was closed in 1961, and ten years later the same was done also in Annopol [15].

The limit values of the parameters that describe the phosphorites deposit in Poland defines that:

- the maximum depth of deposits documentation is 400 meters below the surface,
- the minimum P₂O₅ content in calcium phosphate-rich nodules is 15%,
- the minimum affluence of calcium phosphate-rich nodules is 1 800 kg/m² [14].



Qualitative parameters of the main phosphorites occurrences in Poland are presented in

Table 2.

Table 2. Qualitative parameters of the main phosphorites occurrences in Poland as of 31.XII.2020

Deposit	Calcium phosphate-rich nodules (mm)	P ₂ O ₅ content in calcium phosphate-rich nodules (%)	Affluence of calcium phosphate-rich nodules (kg/m ²)	Affluence versus actual limiting parameters (%)
Annopol	>10	13.5	568	32
Burzenin	>2	18.1	385	21
Chałupki	>10	14.9	354	21
Gościeradów	>2	15.2	496	28
Iłża -Krzyżanowice	>2	18.6	791	44
Iłża -Chwałowice	>2	22.3	891	50
Iłża - Łęczany	>2	18.6	654	36
Iłża - Walentynów	>2	19.9	470	26
Radom – Dąbrówka Warszawska	>2	16.5	upper series – 317 lower series - 460	upper series – 18 lower series - 26
Radom - Krogulcza	>2	19.1	upper series – 218 lower series - 504	upper series – 12 lower series - 28
Radom - Wolanów	>2	15.4	upper series – 170 lower series - 447	upper series – 9 lower series - 25

Source: [15]

The index describing the abundance largely deviates from the boundary values of the parameters that define the deposit. Deposits are flooded which results in their potential exploitation. In addition, railway lines and high-voltage lines, roads or buildings were built in their areas through significant parts of the deposits. In extreme cases, it may cause the resources available for exploitations reduction as much as 50-80%. For the above-mentioned reasons, all deposits from which phosphate rock was obtained in Poland were removed from the national resource balance in 2006, and the domestic demand for phosphate rock raw materials is fully covered by imports, e.g. from Morocco, Algeria and Egypt, where the availability of the described raw materials is much greater and more economical [14]. The structure of the import in Poland in 2016 is presented on **Figure 3**.

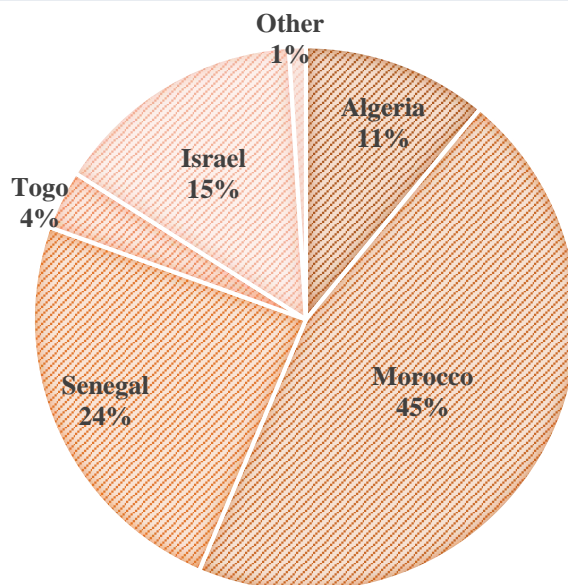

Figure 3. Structure of main importers of phosphate rock and P to Poland
Source: [16]

There is also a lack of economic conditions for qualifying the phosphorites occurrences in Poland as the prognostic resources. Taking into account the current balancing criteria, such occurrences are not economically significant [15].

Phosphorites were documented (based on the more detailed deposit exploration) as one of the accompanying raw materials in the new geological documentation (the supplement no. 1) with recalculated resources of the glauconite-bearing sediments Niedźwiada II deposit approved in 2020. The deposit is located in Lubartów county in Lubelskie Voivodeship. Phosphorites appear here in the form of hard phosphate concretions with an irregular surface, gray-black color and a grain size between 2 and 30 mm. The phosphate phase was defined as hydroxyapatite. These phosphorites in the Niedźwiada II deposit are characterized by a high content of phosphorites content - the average content of P_2O_5 is 22.86%, while the quality criteria for phosphorites are minimum is 15% of P_2O_5 [15].

The state of the resources exploration and the state of the development of the deposit, as well as the volume of production from individual deposits are summarized in **Table 3**.

Table 3. List of phosphorites deposits in Poland as of 31.XII.2020 [thousand tonnes]

	Name of deposit	The state of development	Geological resources in place					Anticipated sub-economic	Economic resources in place as a part of anticipated economic resources	Output	County
			Anticipated economic								
			Total	A+B	C ₁	C ₂	D				
Total number of deposits: 1			8.04	-	8.04	-	-	-	-	-	
Lubelskie Voivodeship number of deposits: 1			8.04	-	8.04	-	-	-	-	-	
1	Niedźwiada II	R	8.04	-	8.04	-	-	-	-	-	lubartowski

Source: [15]

Accepted abbreviations [15]:

- **B** – for solid minerals - mine in a building process, for fuels - prepared for the exploitation or a trial period of the exploitation,
- **E** – exploited,
- **G** – underground natural gas storage facilities,
- **M** – deposit crossed out of the annual report of mineral resources during an analyzed period,
- **P** – deposit covered by the preliminary exploration (in C2+D category, for fuels – in C category),
- **R** – deposit covered by the detailed exploration (in A+B+C1 category, for fuels – in A+B category),
- **Z** – abandoned deposit,
- **T** – deposit exploited temporarily,
- **K** – change of the raw material in a deposit.

Secondary sources of phosphorus

To reduce its dependence on external markets, the European Union has in recent years emphasized the need to look for alternative sources of P. One option is to recover this valuable raw material from selected waste streams. This approach is in line with the assumptions of the circular economy, the European Union economic model, which emphasizes that the transformation towards a circular economy will bring significant economic and environmental benefits for the Member States, including Poland. Activities in the field of recovery of raw materials, including P, are also part of the new European Union

strategy - the European Green Deal [17].

The vital importance of P and its growing deficiency influenced the dynamic development of science in this area [18]. In Poland, there is high potential for the recovery of P from secondary sources such as:

- wastewater and sewage sludge,
- sewage sludge ash,
- animal manure,
- meat and bone meal,
- plant waste,
- industrial waste,
- biomass.

The potential of P recovery from waste in Poland results, inter alia, from a large amount of P available to plants in this waste. **Table 4** shows the values of P concentration in sewage sludge, ashes from sewage sludge, animal manure and compost from plant waste based on the literature review.

Table 4. P concentration in presented types of waste [Mg/kg]

Sewage sludge	13 200	123 000	26 100	65 400
Reference	[19]	[22]	[26]	[30]
Sewage sludge ash	46 200	60 697	127 351	112 425
Reference	[20]	[23]	[27]	[30]
Animal manure	21 400	30 600	32 700	29 500
Reference	[21]	[24]	[28]	[31]
Compost from plant waste	40 900	89 000	83 000	78 000
Reference	[22]	[25]	[29]	[32]

Another factor determining the P recovery potential from these wastes is the large amount generated in Poland, which is presented in **Table 5**.

Table 5. Presented types of waste generated

The amount of sewage sludge produced in total	568 858	2020
Amount of thermally transformed sewage sludge	98 576	2020
Animal manure	297 269	2018
Plant waste	1 738 453	2018

Due to the fact that approximately 60% of Poland's territory is occupied by agricultural land, the demand for P fertilizers is high. 359 thousand Mg of P mineral fertilizers was consumed in 2020.

3.1.3. Use of phosphorus raw materials in food sector in Poland

P is an essential building block of life. It naturally occurs in the environment as organic and mineral compounds, mostly as orthophosphates.

The importance of P is especially visible in the agriculture and food sector. It is commonly known that farmers cannot profitably grow food without P. It is an irreplaceable part of agriculture, as there is no substitute for its use for producing food and feed, and therefore it is a crucial element to maintain food safety (**Figure 4**).

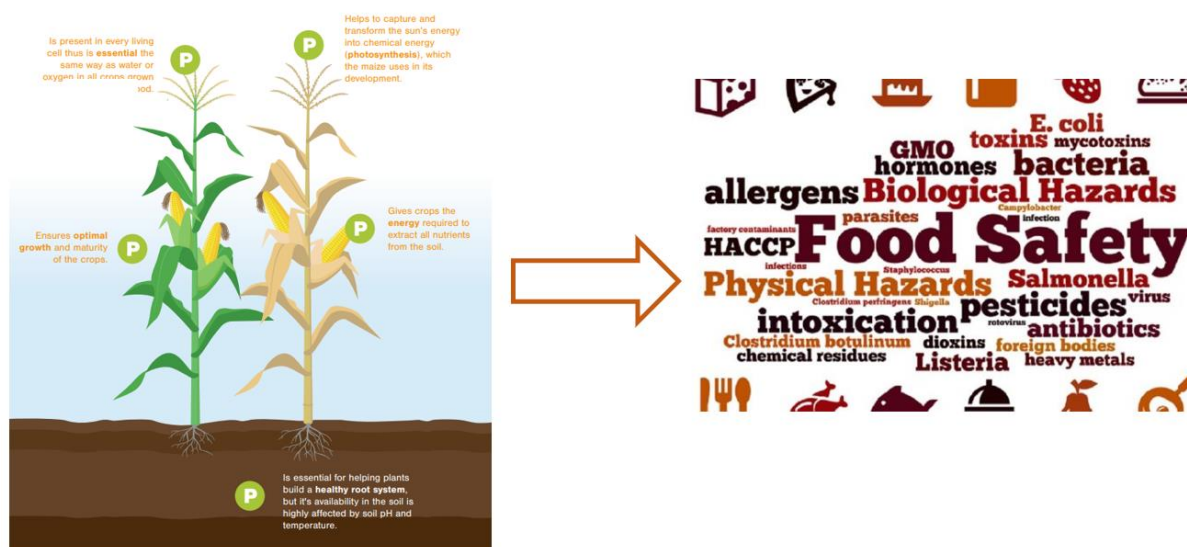

Figure 4. The connection between the role of P in agriculture and food sector
Sources: [33,34]

The objective of P fertilization is to add an adequate (in regard to soil test P) amount of P to produce an economical yield. Unbalanced P management leads to P wastage, lower cost-effectiveness of production, and water quality impairment.

In Poland, P for agriculture is mainly applied as a compound fertilizer, among which diammonium phosphate represents the greatest share. P is regarded as one of the most

important critical raw materials (CRM) for the European economy, and cannot be replaced by any other element.

Regarding global production of phosphate rock, it can be stated that P rock is the main source of P, and based on the data from 2010 to 2014, it can be said that the greatest share of its production can be attributed to China (**Figure 5**).

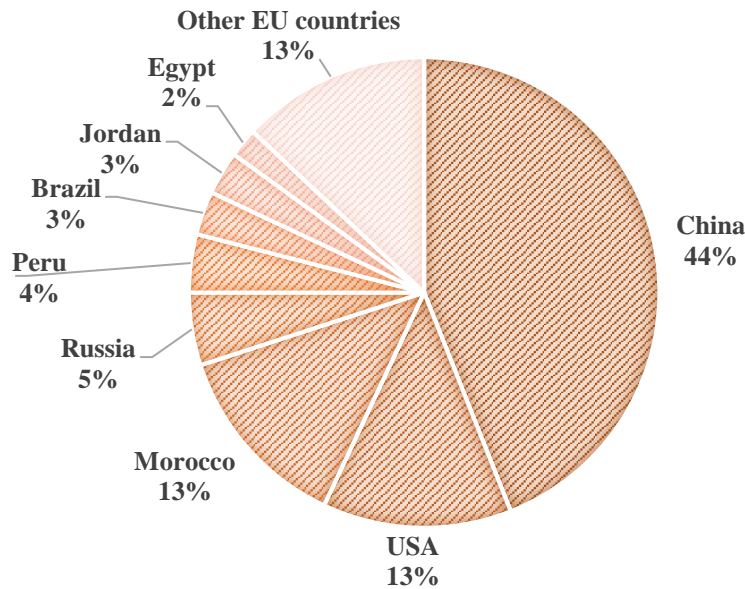

Figure 5. Average global production of phosphate rock (2010–2014) - about 217 million tonnes

The average global end use of phosphate rock in majority is related to mineral fertilizers (**Figure 6**). Because of increasing demand for phosphate in agriculture, food, and other sectors, there is a real need its recycling and recovery.

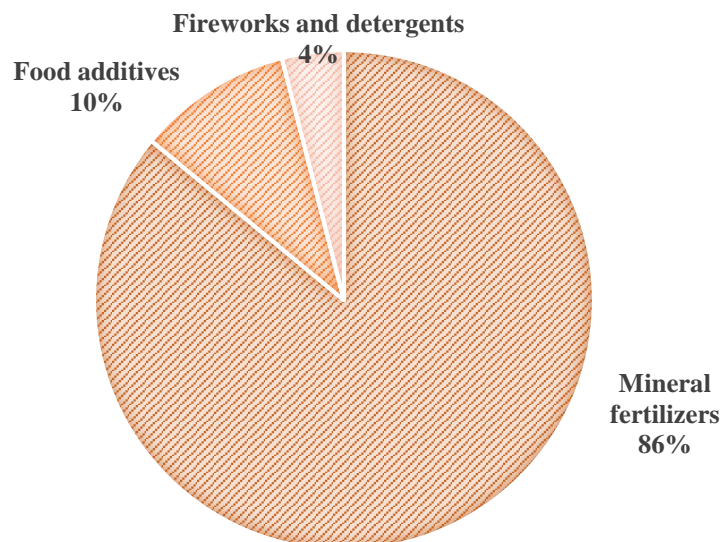

Figure 6. Average global end use of phosphate rock (2010-2014) - about 7.3 million tonnes is EU consumption

Based on statistical data from the Polish Statistical Office, it can be seen that temporal changes in mineral fertilizers consumption occur (**Figure 7**). At present, the total

consumption of mineral fertilizers in Poland is almost 130 kg/ha of agricultural land (AL). The consumption of nitrogen is almost 68 kg/ha. In case of potassium, the consumption is almost 39 kg/ha. The consumption of P is 23.4 kg/ha and is quite stable in the last few years.

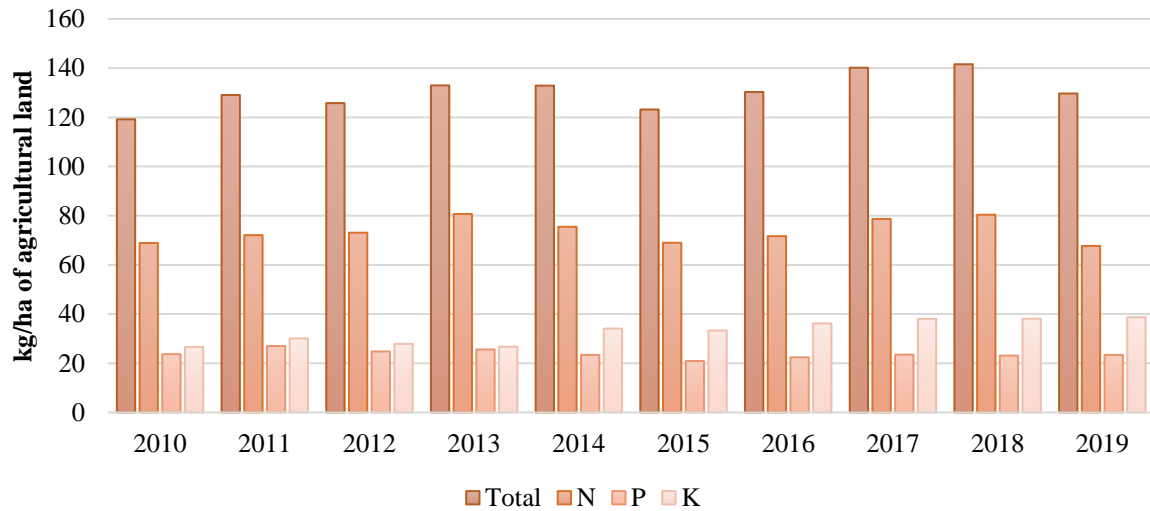

Figure 7. Temporal changes in consumption of mineral fertilizers in Poland

The distribution of mineral fertilizers consumption in Poland is also diversified regionally (Figure 8).

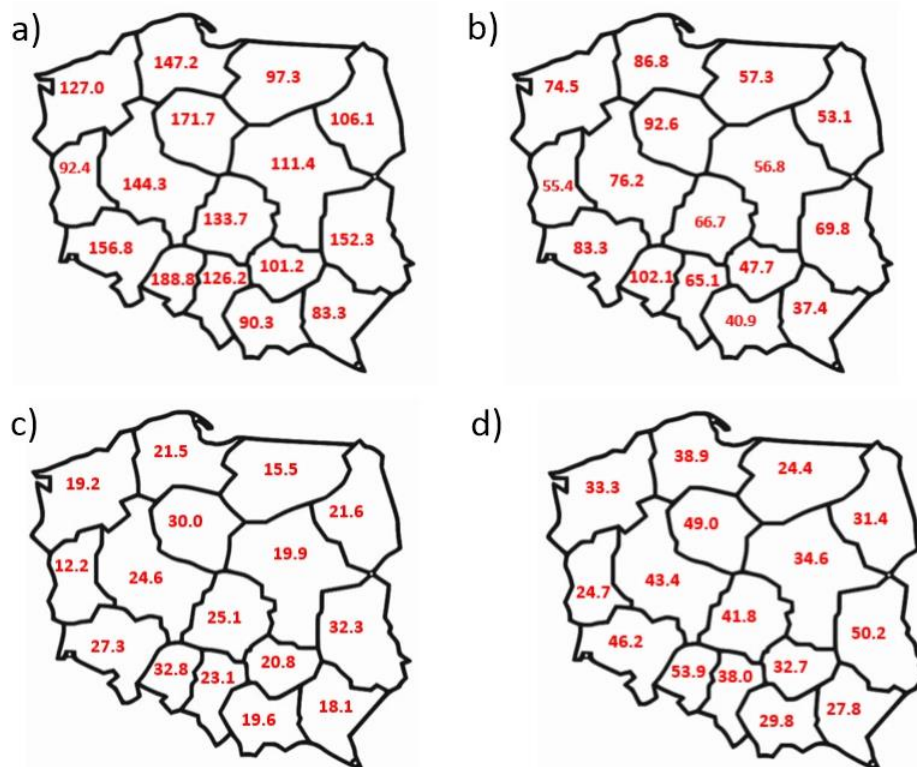

Figure 8. The consumption of mineral fertilizers in Poland: a) total consumption, b) N consumption, c) P consumption, d) K consumption; in kg/ha of AL

The lowest application of mineral fertilizers in total is observed in Podkarpackie voivodship, whereas the greatest amount of mineral fertilizers is applied in Opole voivodship. It is also proportionally visible for other compounds. Also for P fertilizers it is visible that its highest application can be linked with the Opole voivodship. The lowest application of P fertilizers is observed in Warmia and Mazury voivodship.

When comparing Poland to different countries in the world, it can be noticed that this country is placed in the group of countries with significant total consumption of mineral fertilizers (**Figure 9**).

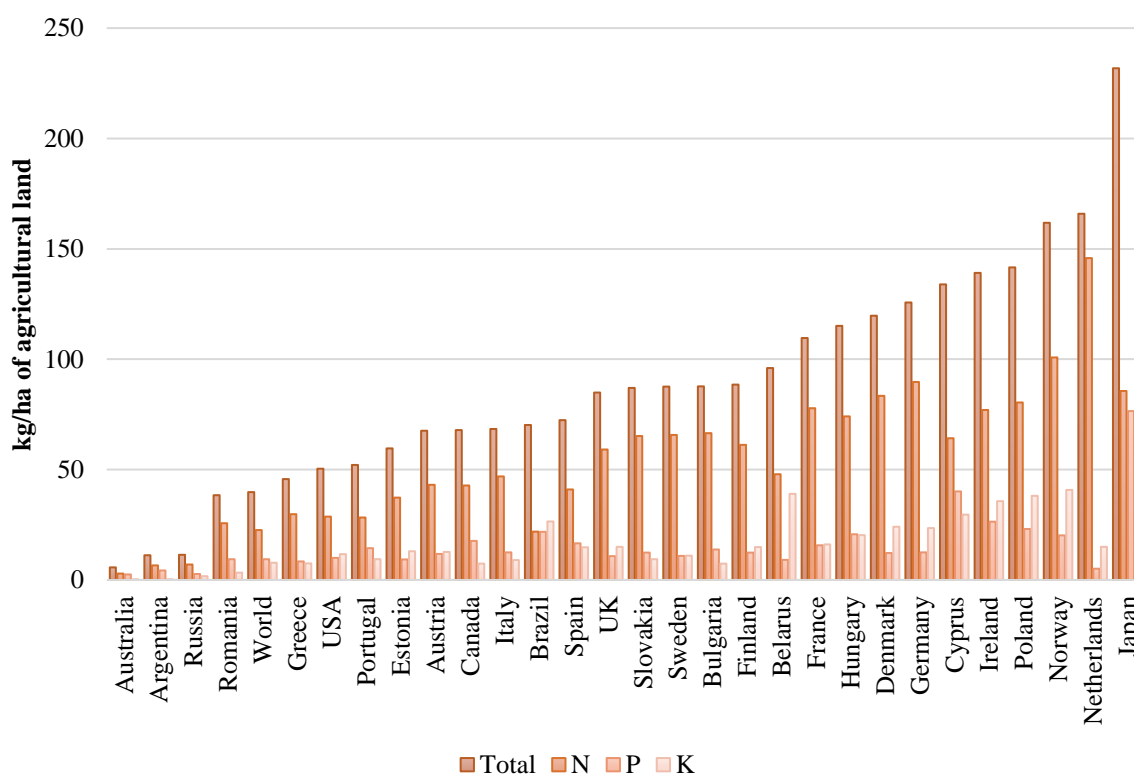

Figure 9. The consumption of mineral fertilizers in selected countries (sorted by total consumption of fertilizers)

Also in terms of the consumption of P fertilizers, Poland is placed high, only below Japan, Cyprus, and Ireland, as shown in **Figure 10**.

The production of fertilizers in Poland (**Table 6**) indicates that the majority fertilizers produced are nitrogenous fertilizers. Phosphatic fertilizers are produced in less amounts. Almost total of phosphatic fertilizers produced in Poland are superphosphates.

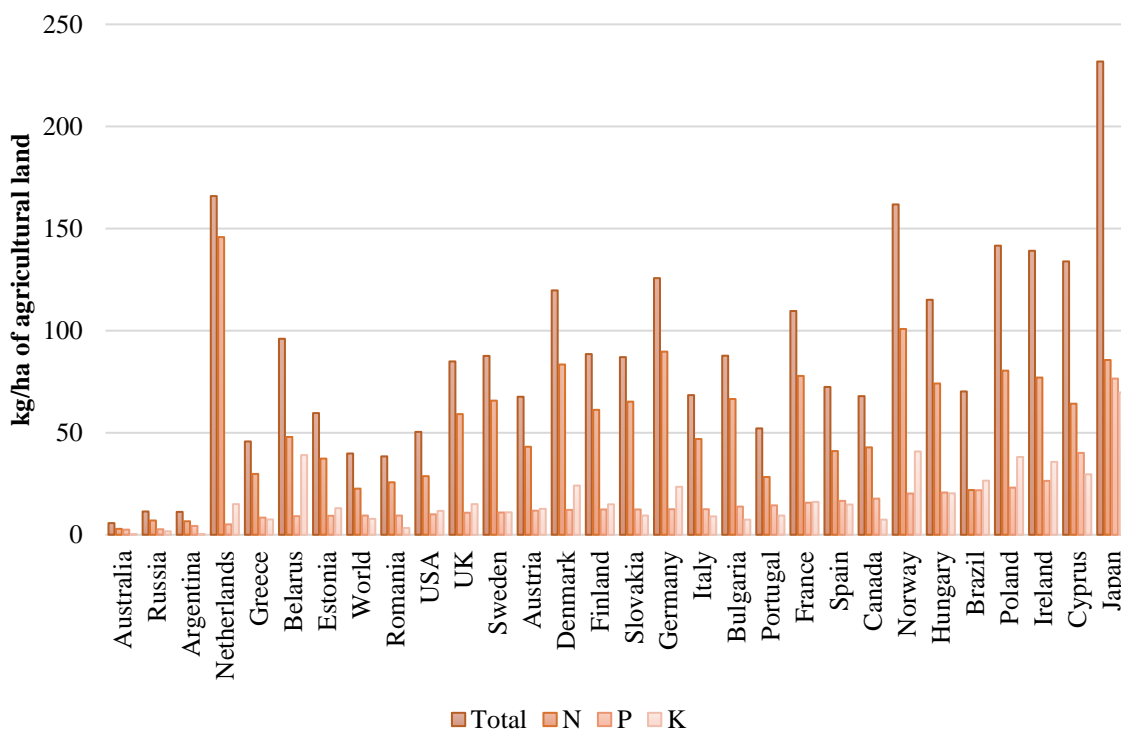

Figure 10. The consumption of mineral fertilizers in selected countries (sorted by consumption of P fertilizers)

Table 6. Production of mineral or chemical fertilizers in Poland

Specification	2010	2015	2017	2018	2019
<i>In commodity mass, in thousand tonnes</i>					
Nitrogenous fertilizers	4709	5858	6047	6003	5971
Ammonium nitrate	1323	1364	1328	1293	1285
Phosphatic fertilizers	310	377	363	390	423
Superphosphate	309	377	363	390	423
Mixed fertilizers	1935	1851	1821	1698	1746
<i>In terms of pure ingredient, in thousand tonnes</i>					
Total	2452	2869	2957	2886	2880
Nitrogenous fertilizers	1637	2010	2058	2023	2005
Phosphatic fertilizers	486	475	469	442	461

The consumption of mineral or chemical and lime fertilizers in Poland, in terms of pure ingredient is varying in time (**Table 7**).

Table 7. The consumption of mineral, chemical and lime fertilizers in Poland per pure ingredient over the years

Specification	2009/10	2014/15	2016/17	2017/18	2018/19
<i>In thousand tonnes</i>					
Mineral or chemical fertilizers					
Total	1771.3	1792.2	2049.8	2076.6	1905.4
Private farms	1488.9	1553.8	1838.5	1873.0	1724.4
Nitrogenous fertilizers					
Total	1023.7	1003.6	1150.6	1178.8	994.1
Private farms	861.7	861.3	1022.1	1055.4	885.3
Phosphatic fertilizers					
Total	351.7	303.6	343.4	338.7	343.5
Private farms	300.5	267.7	313.9	308.5	317.6
Potassic fertilizers					
Total	395.9	485.0	555.8	559.1	567.8
Private farms	326.7	424.8	502.5	509.1	521.5
Lime fertilizers					
Total	590.9	567.6	774.9	808.7	821.0
Private farms	445.5	456.3	627.5	660.0	704.2

Gross balance of N and P in Poland is slightly greater than their average values measured for European Union (**Figures 11-12**). Both the N and P balance is positive. Positive balance of N and P indicates the potential risk of dispersion of these components outside the agroecosystem.

When planning fertilization it is also important to determine soil resources of absorbable macro-elements. In case of P, for the Polish site conditions, soil resources can be characterized as “very low”, “low”, “average”, “high” and “very high” (**Figure 13**).

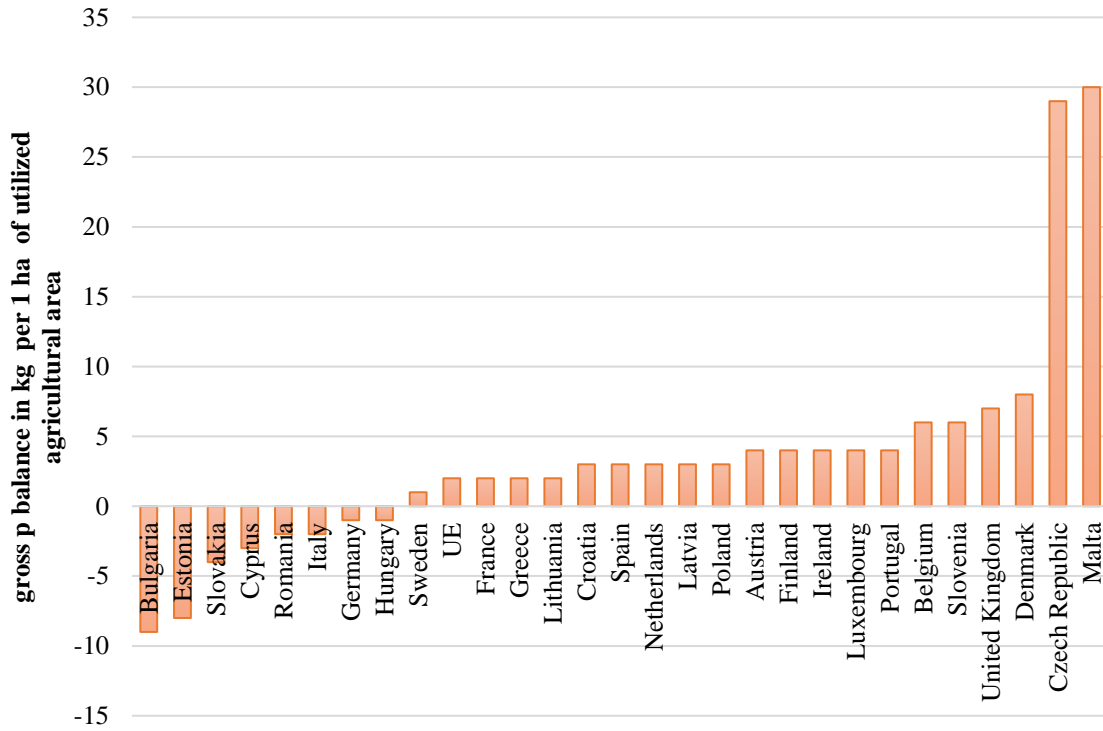

Figure 11. Gross P balance in selected countries

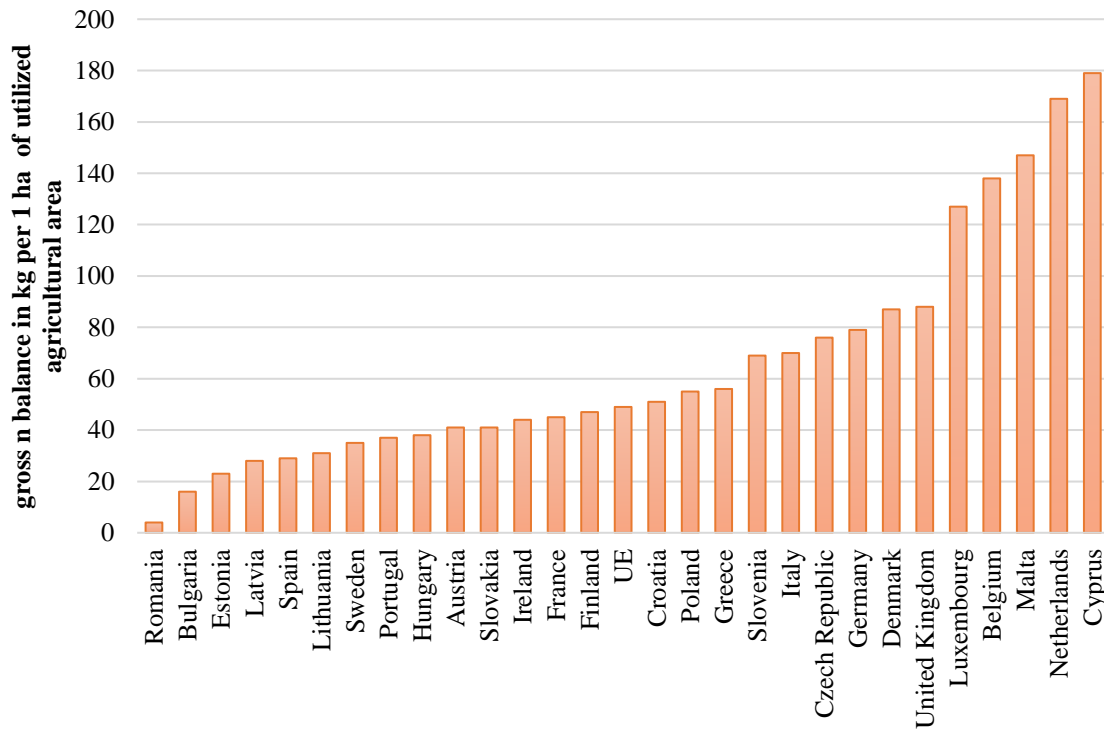

Figure 12. Gross N balance in in selected countries

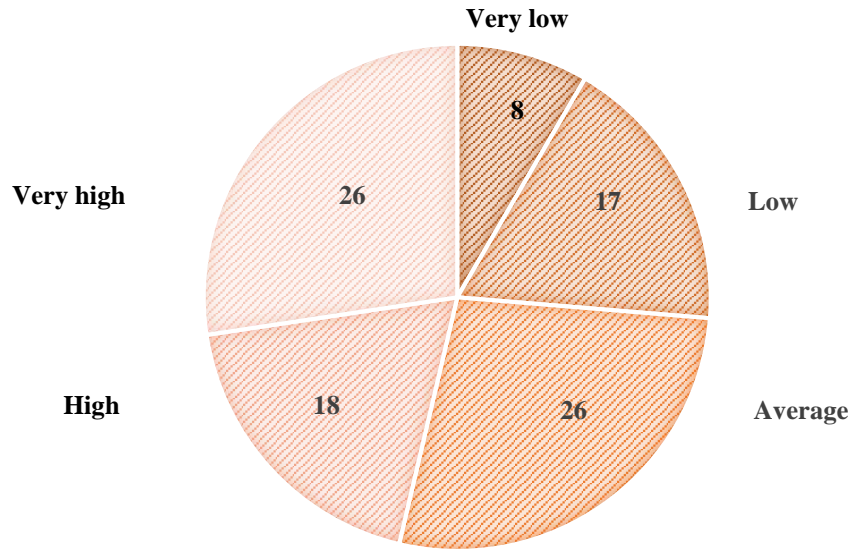

Figure 13. The quality of soil resources of P, in % of samples tested

Based on the findings shown in this study, some future directions can be pointed out. First of all, the fertilizers have to be applied reasonably, in amounts really required by plants, not overused to avoid their losses to the environment. The great solution for that is the application of precision fertilization in which the fertilizers are adjusted strictly to current plant demands, based on previous measurements of soil quality. It is also important to use new technologies and innovative fertilizers, i.e. biofertilizers from secondary raw materials. The crucial is also the farmers' awareness of nutrient efficiency, and the reduction of negative impact on the environment.

3.1.4. Stakeholders involved in the flow of phosphorus raw materials in Poland

- Azoty Group "Fosfory"

Azoty Group "Fosfory" Sp. z o. o. are one of the leaders in the fertilizer and chemical industry in Europe. The highest quality of products and complete customer satisfaction are their priority. By producing agricultural fertilizers, they strive to maximize the benefits of buyers and maintain all environmental protection requirements. Group is a producer of mineral fertilizers that are widely used in agriculture, vegetable cultivation and horticulture. Their offers also included chemical products. The Azoty Group "Fosfory" taking advantage of the location within the Gdańsk port and access to the Chemików Wharf in use, it imports some raw materials for the production of fertilizers by sea. With its experience in maritime trading, the Azoty Group "Fosfory", also conducts a wide range of services and reloading as well as

sea freight of loose and liquid bulk goods in export and import [35].

- Jarocin Waterworks Company

The Jarocin Waterworks Company has signed a contract for carrying out an investment under the project ‘Modernisation and Extension of WWTP Jarocin’. The project includes the implementation of 5 tasks (with a total value of 60 million EUR), supported by co-financing from the European Union. The largest investment in the project is the construction of a station for the recovery of raw materials, such as nitrogen, P and biogas, at the sewage treatment plant in Cielcza. This would allow it to recover between 100 and 200 kg of fertiliser per year. The water and wastewater management project implemented in the Jarocin was recognized with a prestigious award at the international Wex Global 2018 conference, which took place in Lisbon. In the years that follow further will plane the introduction on the market of technologies for the recovery of P, in particular in the wastewater sector [36].

Projects related to sustainable management and recovery of P raw materials from waste

- Sustainable management of phosphorus in the Baltic region (InPhos)

Project “Sustainable management of phosphorus in the Baltic region” (InPhos), received funding from the European Institute of Innovation and Technology (EIT) – a body of the European Union, under the Horizon 2020 program. The main objective of the InPhos project was to develop a strategy for sustainable P management in the Baltic Sea Region by a working group of experts from the Baltic countries – Poland, Germany, Sweden, Finland, Latvia, Lithuania, Estonia and Italy [37].

- Optimising bio-based fertilisers in agriculture – Providing a knowledge basis for new policies (LEX4BIO)

The overall objective of the "Optimising bio-based fertilisers in agriculture – Providing a knowledge basis for new policies" (LEX4BIO) project is to realise potential bio-based fertilisers to transform the agricultural industry by minimising the environmental impact of existing fertilisers and improving sustainability through recycling of nside-streams by decreasing European dependency on finite and imported, apatite-based P fertilisers and energy-intensive mineral nitrogen fertilizer. This project has received funding from the European Union’s Horizon 2020 research and innovation programme [38].

- Market ready technologies for P-recovery from municipal wastewater (PhosForce)

The main objective of the "Market ready technologies for P-recovery from municipal wastewater"(PhosForce) project is to develop an innovative technology for the recovery of P from wastewater. The Struvia® technology has been used to recovery of P in the form of struvite crystals from wastewater generated in municipal waste disposal facilities [39].

- Towards Circular Economy in wastewater sector: Knowledge transfer and identification of the recovery potential for Phosphorus in Poland (CEPhosPOL)

The main goal of the "Towards Circular Economy in wastewater sector: Knowledge transfer and identification of the recovery potential for Phosphorus in Poland" (CEPhosPOL) project was to conduct research works focused on the identification of the recovery potential for P in Poland and development of the sustainable model of the P management, based on the circular economy assumptions. The project was implemented under the Mieczysław Bekker programme for young researchers, financed by the National Academic Exchange Agency (NAWA) [40].

- Polish Fertilizers form Ash (PolFerAsh)

The main goal of the Polish project "Polish Fertilizers form Ash" (PolFerAsh) was to develop an environmentally-friendly technology for sewage sludge ash utilization as a source of fertilisers and construction materials. The project has been conducted in the Cracow University of Technology and Mineral and Energy Economy Research Institute of the Polish Academy of Sciences in Poland, and has received the founding from the National Centre for Research and Development [41].

References

- [1] Phosphorus, www.britannica.com/science/phosphorus-chemical-element (accessed on 21 December 2021).
- [2] Phosphorus Physical Data, <https://www.thoughtco.com/phosphorus-facts-606574> (accessed on 21 December 2021).
- [3] Eichstaedt I. (1973). Book of chemical elements (Księga pierwiastków). Warsaw: Wiedza Powszechna (in Polish)
- [4] Greenwood N., Earnshaw A. (1997). Chemistry of the elements. Butterworth-Heinemann: Oxford.
- [5] Lityński T., Jurkowska H. (1982). Soil fertility and plant nutrition (Żyzność gleby i



- odżywianie się roślin). Warsaw: Państwowe Wydawnictwo Naukowe (in Polish).
- [6] Fotyma M., Igras J., Kopiński J. (2009).
- [7] Production and environmental conditions of fertilization management in Poland (Produkcyjne i środowiskowe uwarunkowania gospodarki nawozowej w Polsce). Puławy (in Polish).
- [8] Czuba R. (1996). Nawożenie mineralne upraw (Nawożenie mineralne roślin uprawnych). Zakłady Chemiczne "POLICE" S.A. (in Polish)
- [9] Commission of European Communities (2014). Communication on the review of the list of critical raw materials for the EU and the implementation of the Raw Materials Initiative (COM no. 297, 2014).
- [10] Commission of European Communities (2017). Communication on the 2017 list of Critical Raw Materials for the EU (COM no. 490, 2017).
- [11] Sapek A. (2009). Phosphorus in the human food chain and the environment in Poland (Fosfor w łańcuchu pokarmowym człowieka a środowisko w Polsce). Inżynieria Ekologiczna, 62-72 (in Polish).
- [12] Wzorek Z. (2008). Recovery of phosphorus compounds from thermally processed waste and their use as a substitute for natural phosphorus raw materials (Odzysk związków fosforu z termicznie przetworzonych odpadów i ich zastosowanie jako substytutu naturalnych surowców fosforowych). Politechnika Krakowska, Monografia (in Polish).
- [13] Skwierawski A. (2004). Accumulation of phosphorus in water and bottom sediments as an indicator of the degradation level of rural ponds and mid-field ponds (Akumulacja fosforu w wodzie i osadach dennych jako wskaźnik poziomu degradacji stawów wiejskich i oczek śródpolnych). Prace Naukowe Akademii Ekonomicznej we Wrocławiu, 183-192 (in Polish).
- [14] Sapek B. (2014). Akumulacja i uwalnianie fosforu w glebach – źródła, procesy, przyczyny (Nagromadzanie i uwalnianie fosforu w glebach – źródła, procesy, przyczyny). Woda-Środowisko-Obszary Wiejskie, 14, 77-100 (in Polish).
- [15] Polish Geological Institute – National Research Institute (2013). Minerals Yearbook of Poland 2013, Warsaw.
- [16] Polish Geological Institute – National Research Institute (2021). The balance of mineral resources deposits in Poland as of 31.12.2020, Warsaw.
- [17] Central Statistical Office (2017). Environment 2017, Warsaw.





- [18] Smol M., Marcinek P., Duda J., Szoldrowska D. (2020). Importance of Sustainable Mineral Resource Management in Implementing the Circular Economy (CE) Model and the European Green Deal Strategy. *Resources*, 9(5):55.
- [19] Smol M. (2019). The importance of sustainable phosphorus management in the circular economy (CE) model: the Polish case study. *J Mater Cycles Waste Manag* 21, 227–238.
- [20] Krzywy E., Iżewska A., Włoszczyk, C. (2004). Assessment of the chemical composition and fertilizing value of sewage sludge and composts produced from municipal sewage sludge (Ocena składu chemicznego i wartości nawozowej osadu ściekowego oraz kompostów wyprodukowanych z komunalnego osadu ściekowego). *Zesz. Probl. Postępów Nauk Rol.* 499, 165–171 (in Polish).
- [21] Mattenberger H., Fraissler G., Brunner T., Herk P., Hermann L., Obernberger I. (2008). Sewage sludge ash to phosphorus fertiliser: Variables influencing heavy metal removal during thermochemical treatment. *Waste Manag.* 28, 2709–2722.
- [22] Gondek K., Filipek-Mazur B. (2006). Accumulation of micronutrients in oat biomass and their availability in soil fertilized with plant waste compost (Akumulacja mikroelementów w biomacie owsa oraz ich dostępność w glebie nawożonej kompostem z odpadów roślinnych). *Acta Agrophysica* 8, 579–590 (in Polish).
- [23] Gondek K., Filipek-Mazur B (2005). The content and uptake of micronutrients by oats under the conditions of fertilization with composts of various origins in terms of feed value and environmental impact (Zawartość i pobranie mikroelementów przez owies w warunkach nawożenia kompostami różnego pochodzenia w aspekcie wartości paszowej i wpływu na środowisko). *Woda-Środowisko-Obsz. Wiej.* 1, 81–93 (in Polish).
- [24] Ciarán J. Lynn, Ravindra K. Dhir, Gurmel S. Ghataora, Roger P. West (2015). Sewage sludge ash characteristics and potential for use in concrete. *Construction and Building Materials.* 98, 767-779.
- [25] Marcato C.E., Pinelli E., Pouech P., Winterton P., Guisresse M. (2008). Particle size and metal distributions in anaerobically digested pig slurry. *Bioresour. Technol.* 99, 2340–2348.
- [26] Halik J., Chowaniak M., Poczesna E., Polak E. (2004). Agrochemical assessment of the fertilizing value of composts (Agrochemiczna ocena wartości nawozowej kompostów). *Mater. II Ogólnopolskiej Młodzieżowej Konf. Nauk.* 96–100 (in Polish).



- [27] Poluszuńska J., Ślęzak E. (2015). Possibilities of phosphorus recovery from sewage sludge (Możliwości odzysku fosforu z osadów ściekowych). Pr. Inst. Ceram. i Mater. Bud. 21, 7–21 (in Polish).
- [28] Herzelc H., Krügera O., Hermann L., Adama Ch. (2016). Sewage sludge ash — A promising secondary phosphorus source for fertilizer production. Science of The Total Environment. 572, 1136-1143.
- [29] Gollehon N., Caswell M., Ribaud M., Kellogg R., Lander C., Letson D. (2001). Confined animal production and manure nutrients. Agric. Inf. Bull. 771. USDA–Econ. Res. Serv., Resour. Econ. Div., Washington, DC.
- [30] Gondek K. (2007). Accumulation of heavy metals in oat fertilized with compost (Akumulacja metali ciężkich w owsie nawożonym kompostami). Acta Agrophysica 10, 89–102 (in Polish).
- [31] Tabatabai M.A., Frankenberger W.T. (1979). Variability of chemical properties of sewage sludges in Iowa 36, 13.
- [32] Risberg K., Cederlund H., Pell M., Arthurson V., Schnurer A. (2017). Comparative characterization of digestate versus pig slurry and cow manure – Chemical composition and effects on soil microbial activity. Waste Manag. 61, 529-538.
- [33] Chiew Y.L., Spångberg J., Baky A., Hansson P.A., Jönsson, H. (2015). Environmental impact of recycling digested food waste as a fertilizer in agriculture – A case study. Resour. Conserv. Recycl. 95, 1–14.
- [34] Phosphorus in food production, www.fertilizerseurope.com/wp-content/uploads/2019/12/Phosphorus-in-food-production.pdf (accessed on 21 December 2021).
- [35] Who opens consultation on draft food safety strategy, www.foodsafetynews.com/2021/05/who-opens-consultation-on-draft-food-safety-strategy (accessed on 21 December 2021).
- [36] Azoty Group “Fosfory” Sp. z o.o., www.fosfory.pl (accessed on 20 December 2021).
- [37] The plant in Jarocin will produce agricultural fertilizer from sediments, www.portalkomunalny.pl/oczyszczalnia-w-jarocinie-wyprodukuje-nawoz-rolniczy-z-osadow-374791 (accessed on 20 December 2021).
- [38] Project “Sustainable management of phosphorus in the Baltic region” (InPhos), www.min-pan.krakow.pl/projekty/en/2019/07/17/english-zrownowazone-zarzadzanie-fosforem-w-regionie-baltyckim/ (accessed on 20 December 2021).



- [39] Project “Optimising bio-based fertilisers in agriculture – Providing a knowledge basis for new policies” (LEX4BIO), www.lex4bio.eu (accessed on 20 December 2021).
- [40] Project “Market ready technologies for P-recovery from municipal wastewater” (PhosForce), www.min-pan.krakow.pl/projekty/en/2019/07/17/technologie-odzysku-fosforu-ze-sciekow-komunalnych/ (accessed on 19 December 2021).
- [41] Project “Towards Circular Economy in wastewater sector: Knowledge transfer and identification of the recovery potential for Phosphorus in Poland” (CEPhosPOL), www.min-pan.krakow.pl/projekty/en/2019/07/16/program-stypendialny-im-mieczyslawa-bekker/ (accessed on 19 December 2021).
- [42] Smol M., Kulczycka J., Lelek Ł., Gorazda K., Wzorek Z. (2020). Life Cycle Assessment (LCA) of the integrated technology for the phosphorus recovery from sewage sludge ash (SSA) and fertilizers production. Arch. Environ. Prot. 46, 42–52.



3.2. Czech Republic

3.2.1. Introduction and framework

Phosphorus – various forms and main applications

It is a chemical element with the symbol P and atomic number 15. Elemental P exists in two major forms: white and red.

Main applications:

- Fertiliser Organophosphorus,
- Metallurgical aspects,
- Water softening,
- Miscellaneous.

Importance - for industry, agriculture, health

P is essential for plant and animal growth and is necessary to maintain profitable crop and livestock production. It can also increase surface waters biological productivity by accelerating eutrophication, the natural ageing of lakes or streams brought on by nutrient enrichment.

Worlds usage of P:

- 85 % fertilisers,
- 7 % feed phosphates,
- 3 % detergents, technical phosphates,
- 1 % food phosphates,
- 1 % glyphosates,
- 1 % other actual P₄ derivatives.

3.2.2. Phosphorus raw materials in Czech Republic

Sources, processing and management of P in the Czech Republic and neighbour countries

P has a concentration in the Earth's crust of about 1 g/ 1 kg (compare copper at about 0.06 g/kg). It is not found free in nature, but is widely distributed in many minerals, usually as phosphates.

85 % of Earth's reserves are in Morocco, with smaller deposits in China, Russian Federation, the USA and elsewhere.

Phosphate rock is finite, non-renewable and highly concentrated among countries that are sometimes politically unstable.

Risk of a lack of investments or production shut-down

Risk of resource depletion on the medium run in these countries and finally a higher resource concentration at the global level. Implementation of exports tax reduce the availability of phosphorous fertilisers on the world market. The European industry is facing higher production cost.

Consumption of various forms of phosphates in the Czech Republic and neighbour countries as fertilizers (**Table 8**).

Table 8. Consumption of various forms of phosphates

Country	Consumption of various forms of phosphates [t]
Czech Republic	300 000
Austria	117 000
Germany	1 400 000
Poland	1 000 000
Slovakia	120 000
Hungary	440 000

Impact of P on the environment

Too much P can cause increased growth of algae and large aquatic plants, resulting in decreased levels of dissolved oxygen– a process called eutrophication. High P levels can also lead to algae blooms that produce algal toxins, which can be harmful to human and animal health.

Some scientists call P cholesterol of the 21st century. Excess P is harmful to blood vessels - cholesterol tends to clog blood vessels, and P reduces elasticity.

3.2.3. Stakeholders involved in the flow of phosphorus raw materials in Czech Republic

The important P processors in the Czech Republic

- FOSFA a.s., Poštorná



Figure 14. FOSFA a.s., Poštorná
Source: [1]

FOSFA a.s. is the largest processor of yellow P in Europe and a successful exporter. FOSFA was founded in 1884. After the successful resumption of phosphoric acid production, the company decided to invest in the production of special applications based on P and detergents.

At present, FOSFA a.s. products for food (processing of meat, poultry and seafood, cheese and dairy products, for the bakery industry and production of quality wines of fruit distillates and alcohol and industrial applications (industrial cleaning).

Production scope of FOSFA a.s. consists of product groups:

- sodium phosphates,
- potassium phosphates,
- ammonium phosphates,
- thermal phosphoric acid.

During production, FOSFA a.s. keeps principles of sustainable development and footprint reduction strongly.

- LOVOCHEMIE a.s., Lovosice



Figure 15. LOVOCHEMIE a.s., Lovosice
Source: [2]

LOVOCHEMIE, a.s., is the largest producer of fertilisers in the Czech Republic, and its production program has significantly contributed to the development of Czech agriculture. Fertiliser production has been in Lovosice since 1904 and LOVOCHEMIE, a.s. produced fertilisers until 1993.

In Lovosice 1969 a started up NPK production line was to process Apatite. The shutdown of this unit was in 2015. Now LOVOCHEMIE, a.s. still produces NPK fertilisers in Mestec Kralove and considers production in Lovosice in the future. Production Scope of LOVOCHEMIE consists of products: NPK Cererit Lovogreen Lovostart NP with humáty a micro Zeorit NPK with zeolite Fosmag LOVOCHEMIE, a.s. is trying to find long-term sustainable sources of P to replace current raw materials in future.

Although P is the 11th most common element in the Earth's crust, in the form of P compounds is literally ubiquitous. There is a danger that we may soon face a critical P deficiency.

- Czech Phosphorus Platform (CPP)

It is an organisation that brings together private companies, government agencies, academic institutions and individuals. The fossil resources from which P has so far been predominantly extracted are limited and depleted each year. The peak of P mining is expected in several decades.

The attention of scientists and researchers is increasingly focused on sourcing from hitherto neglected sources such as recycling, circular economy, waste management, sustainable agriculture and further.

CPP creates conditions for various activities of members in the area of recycling, circular economy, waste management, sustainable agriculture and water management to reduce dependence on imports and to recycle P from waste, from crop and animal production in agriculture, from industrial and municipal wastewater.

Figure 16 shows water pollutant releases changes (2010 to 2019).

	Cd, Hg, Ni, Pb	TOC	Total N	Total P
Austria	-33.6%	-22.6%	0.7%	-21.9%
Belgium	-40.3%	-4.4%	-14.0%	20.7%
Bulgaria	-63.1%	-52.2%	-59.4%	-78.3%
Croatia	222.6%	0.2%	165.3%	235.0%
Cyprus	12294.7%	-20.4%	-3.7%	2677.2%
Czechia	-48.0%	-10.4%	-39.7%	-26.4%
Denmark	-20.1%	21.4%	35.5%	30.8%
Estonia	15.4%	55.3%	-34.9%	-60.5%
Finland	-59.3%	-63.0%	-7.8%	52.4%
France	-81.8%	-89.9%	-37.5%	-20.7%
Germany	-26.6%	-19.1%	-28.8%	-32.2%
Greece	236.7%	-55.4%	5.4%	-1.7%
Hungary	-80.4%	-55.5%	-70.4%	-76.0%
Ireland	-41.8%	40.5%	39.6%	18.2%
Italy	-24.8%	-23.1%	-24.8%	-40.9%
Latvia	35.1%	-47.1%	-48.2%	33.0%
Lithuania	-72.4%	-86.4%	-83.8%	20.2%
Luxembourg	-44.4%	-70.7%	-55.1%	-61.6%
Malta	-94.7%	0.7%	162.7%	105.3%
Netherlands	-53.4%	-45.0%	-42.5%	-48.2%
Poland	-53.0%	-13.1%	-43.1%	-32.2%
Portugal	-15.9%	-38.0%	28.3%	-11.2%
Romania	-72.5%	-15.1%	-25.1%	-33.7%
Slovakia	-37.5%	-36.3%	-42.8%	-52.0%
Slovenia	61.1%	-5.8%	-46.4%	-18.5%
Spain	2.6%	169.2%	49.9%	21.3%
Sweden	-20.2%	-5.8%	0.0%	-3.8%

Figure 16. Water pollutant releases changes (2010 to 2019)

Example of good practice of P regulation

- Cleaning of the Brno lake from excess P

The Brno lake is the largest reservoir on the Svatka River in front of the city and hub of Brno (~500,000 inhabitants), measures 10 km in length, the flooded area is 259 ha, and the permanent reservoir reaches 7.6 M m³, the storage area than another 10.8 M m³ (**Figure 17**).



Figure 17. Brno lake

The main problem of Brno lake for a long time was green cyanobacteria, which polluted the entire water area and made recreation impossible.

The first phase of cleaning Brno lake started 14 years ago. Continuous work will continue until the end of the 2022 season. Project how to stop and improve gradual deterioration of water quality at the Brno lake, especially from flushing water, is called "Implementation of Measures at the Brno Valley Reservoir", which aims to reduce the effects of excessive eutrophication on water. P precipitation takes place at the tributary, which is further intensified by the operation of aeration and destratification towers.

Aeration system in combination with ferric sulphate dosing ensures the precipitation of P, which sinks to the bottom and becomes (so far) its harmless part. Results show an improvement in water quality in the lake, although there is still a long way how to achieve sustainability.

The cleaning of the Brno lake continues - a check in November 2021 showed that the measures were correct, but much remains to be done.

Water purification and treatment in the lake began in 2007 when the banks were liming. In the following years, sediments deposited at the bottom of the reservoir were dredged. Following the release of the surface, a system of aeration towers was put into operation. These aerators promote sediment oxidation and mix the upper water column with the lower one, thereby reducing cyanobacteria. Destratification towers also operate on Brno lake. These help to balance the water temperature at the bottom and on the surface of the lake; this process also prevents massive cyanobacterial reproduction. Furthermore, systems are used to precipitate P, which is the main food for bacteria and most often enters the water with rainwater from fields where farmers use it as fertiliser.



Figure 18. Brno lake

The transformation of the composition of the fish in the dam is also interesting. In the past, carp fish, which feed on bottom-dwelling organisms and swirl sediments, helped cyanobacteria to grow. Carp have been partially replaced by more predatory fish species: zander, perch and pike, which better stabilise the lake ecosystem.



Figure 19. Brno lake

These measures have proved very successful over the years and therefore continue during the next stage of the project, "Implementation of measures at the Brno Valley Reservoir, IVth stage 2023-2027".

The project is managed and implemented by the Moravia River Basin District. Its staff monitors the state of the water, monitors the health of aquatic animals and generally finds out how the dam is doing thanks to continuous care.

The results are carefully monitored not only by the control authorities but above all by taxpayers - citizens of Brno - who recreates on the shores of Brno lake.



The next significant necessary steps are the removal of precipitated P from the bottom of the Brno lake and recovery of P by recycling.

3.2.4. Phosphorus and our health

Necessity or poison?

Like calcium, P is essential for our health.

P is essential for our health, and its deficiency leads to disease.

At an ancient time when the main problem of humanity was malnutrition, people suffered, among other things, from diseases associated with its deficiency.

At present, however, the situation is the opposite: due to the consumption of large amounts of protein and especially industrially processed foods, we have an excess of P, which can lead to damage to our blood vessels.

Neither so nor other – the only criterion is the correct quantity!

Under the influence of these facts, some scientists call P cholesterol of the 21st century. P does have many similar features. Both substances are excessively harmful to blood vessels - cholesterol tends to clog blood vessels, P reduces their elasticity.

And this is not the first time that even things that are basically good are proving to be harmful in large quantities. Today we absorb much more P than our ancestors. But our metabolism is still set in a situation that existed millions of years ago when meat and protein intake were much lower than today.

We accept P in two forms: firstly, as a natural component of protein, i.e. meat and dairy products, the second source is compounds that are added to food during industrial processing, which often contain P, especially various dyes and preservatives.

The less P the body contains, the longer it lives, researchers found.

In general, if someone has low P in the blood, it is a statistical precondition for longevity. It turned out that this is true in nature. Even animals that have high levels of P in their blood have a shorter lifespan, such as small rodents. And as animals live longer, they have lower P levels.

The lowest P levels have been found in people who have lived to be 100 years old.





References

- [1] FOSFA a.s., Poštorná, www.fosfa.cz
- [2] LOVOCHEMIE a.s., Lovosice, www.lovochemie.cz



3.3. Hungary

3.3.1. Introduction and framework

Figure 20 shows the global level flows and losses of materials. The individual material flows and losses may variant among economies, but the life cycle of P is well represented in general.

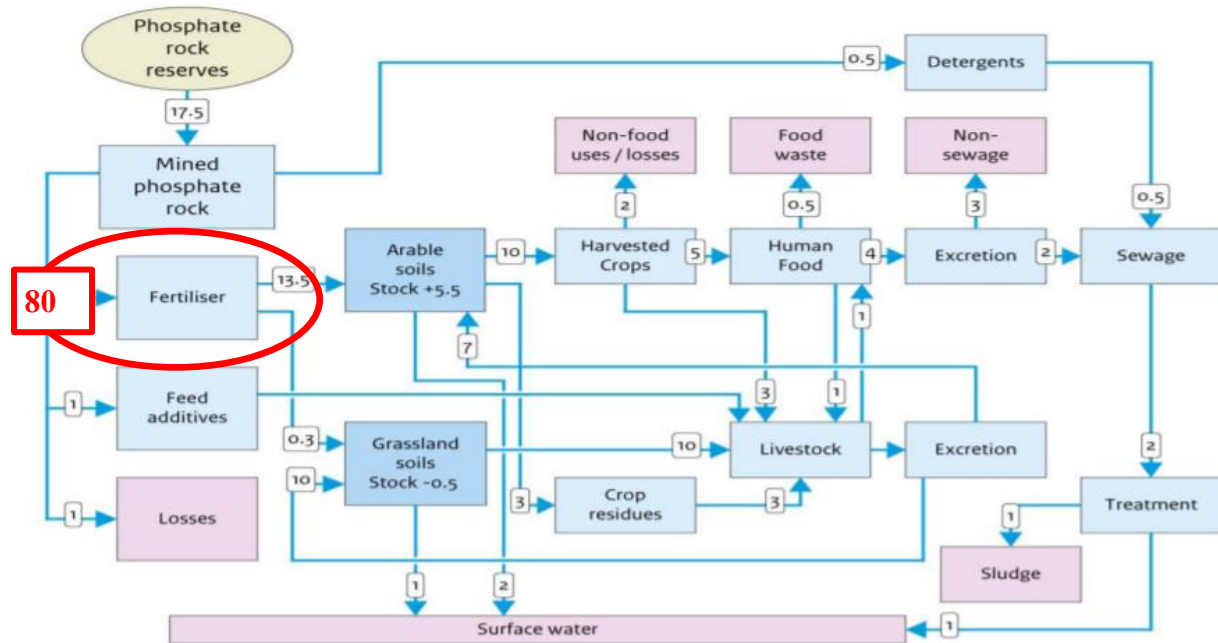

Figure 20. Global P flows in agricultural, food and wastewater systems, 2000 [million tonnes P / year]
Source: [1]

The light blue text boxes represent each use status and activity. And the red text boxes represent each end of the P life cycle.

Figure 20 shows that P has three major industrial uses:

- Fertilizers more than 80%
- Feed additives about 6%
- Detergents about 3%
- Losses between 10% and 11%

Fertilizer using is the most complicated area in this case. The two types of fertilizer applications appear in the input P stream primarily for used arable soil, followed by minimal amounts for grassland soils management. After arable soils use comes the harvesting of the crops.

A significant proportion of this is sent for harvested crops processing and a minimal proportion is fed to animals in the crop residues from the harvest. After harvesting crops, P flows in 3 directions to non-food use and other losses (20%), then to livestock (30%) and finally to human food use/processing (50%). The food industry also receives

P from animal husbandry. A minimal percentage of this leaves the system in the food waste stream, but 90% of the food is excreted from the biological body through the metabolic pathway and some of this is in sewage, while a large proportion is not in non-sewage category. After sewage treatment, half of the total volume is discharged to sludge and half to groundwater. In the case of grassland soil management, there is a kind of rotation, because organic manure is originated after livestock, which is used 58% for fertilising arable soils and 42% for grassland. On the other hand the P in groundwater is finished by organic manure or fertiliser of arable land and grassland.

The feed additives category is linked to the P fluxes through the feeding of animals, as it is linked to the P fluxes described in the previous paragraph through the post-animal activity of organic fertilisation of arable land and pasture, in the one hand, and the processing and consumption of animal meat by the food industry on the other.

Detergents have the shortest life cycle, as they are discharged to wastewater after detergent production and use, and after treatment, they are half and half discharged to sludge and surface water.

3.3.2. Phosphorus raw materials in Hungary

The graph below (**Figure 21**) shows the distribution of agricultural P use per hectare in the EU Member States.

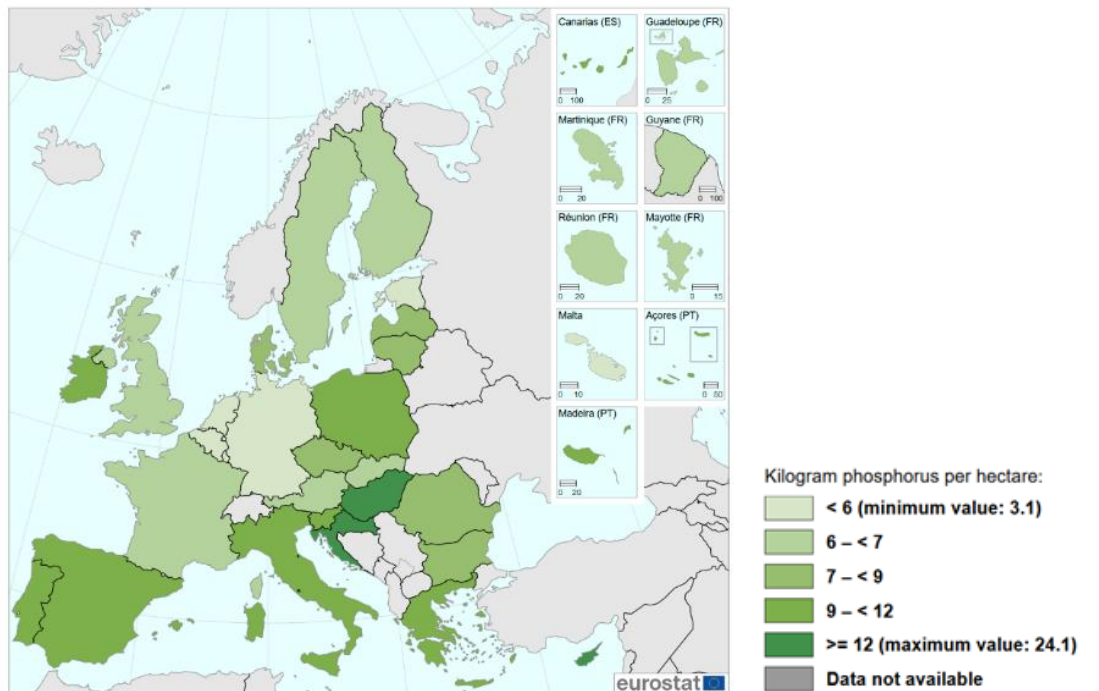

Figure 21. Nitrogen fertiliser consumption per hectare of fertilised agricultural area, EU-28, 2018

Source: [2]

The amount of P used per hectare of fertilised utilised agricultural area averaged 8.6 kg per hectare for Europe in 2018. Several countries, especially in southern and Eastern Europe, are above the European average. The highest values of more than 12 kg P per hectare can be observed for Cyprus, Croatia and Hungary [2]. It can be seen that Hungary has one of the most intensive agricultural consumption on P.

3.3.3. Use of phosphorus raw materials in food sector in Hungary

Hungary is a major player in agricultural production at EU level (**Figure 22**). Hungary is the largest of the major EU producer countries in terms of GDP distribution. Agriculture accounts for a significant share of P use as a result of pesticides and fertilisers. Agricultural area of Hungary in 2019 5.309 thousand hectares (57% of the total area of Hungary).

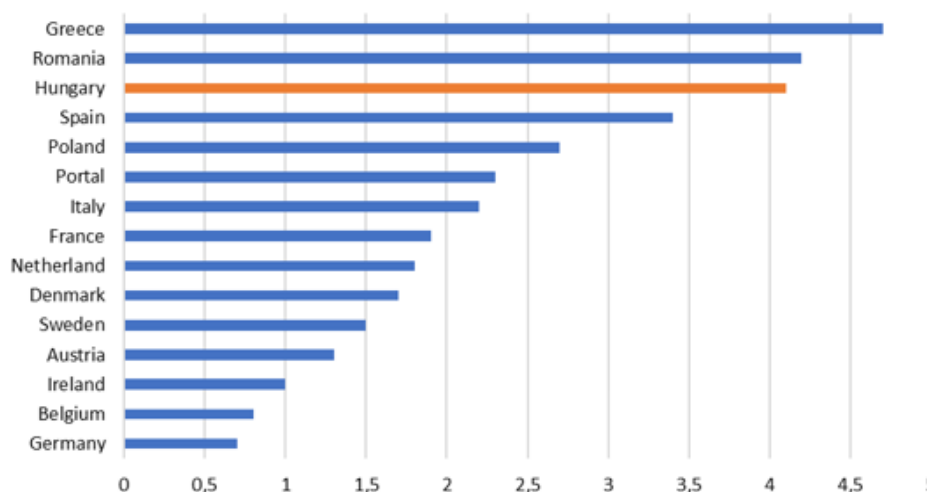

Figure 22. Share of agriculture in gross value added at the EU's biggest emitting countries 2020 [%]
Source: [3]

In Hungary, agriculture accounted for roughly 4% of gross domestic product (GDP). This is due to a downward trend compared to the last 25 years, but the strengthening of the other side of the economy may have reduced these percentages (**Figure 23**). Agriculture achieved a trade indicator of 106.3% in 2020 compared to the previous year.

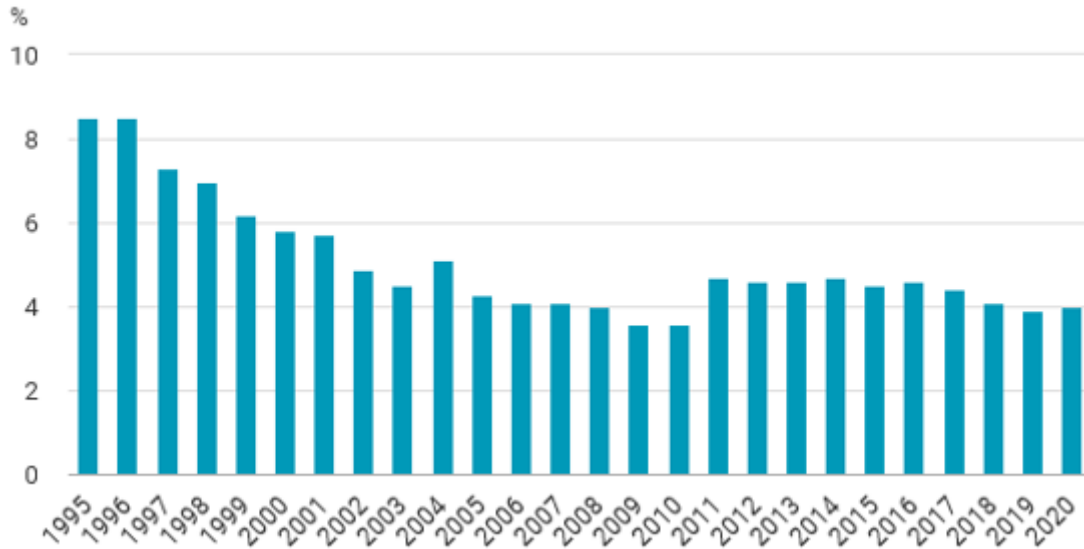

Figure 23. Share of agriculture, forestry and fishing in gross value added
Source: [4]

The graph below (**Figure 24**) shows the change in the average rent paid by landlords to tenants over the last 10 years, averaging 4,400 [HUF/hectare] in 2020.

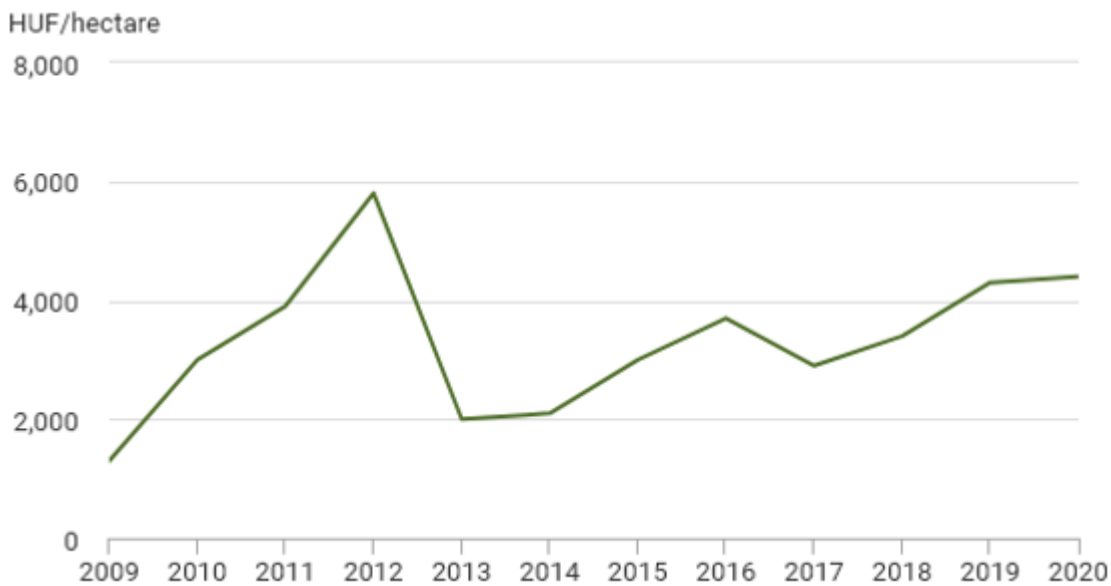

Figure 24. Change in annual rent for arable land
Source: [4]

It can be seen from the previous examples that in Hungary the condition and indicators of agricultural land are surveyed on an annual basis. These data also relate to the production and marketing of animal products. The impact of agriculture on the environment is largely influenced by the technologies and practices used in production, and therefore the statistical field also produces reports on topics such as organic farming, fertiliser use and pesticide use rates.

Amount and Rate of P in Fertilizers Consumed in Hungary

An important indicator is the quantitative distribution of fertiliser raw materials during production. The graph below (**Figure 25**) shows the amounts of the three components (nitrogen, P, potassium) in the fertilisers sold since 2010. Nitrogen accounts for a significant proportion of the raw materials used in fertilisers, while the P and potassium are present in modest proportions. Nitrogen has increased about 1.5-fold in 10 years, while P and potassium have doubled in that time.

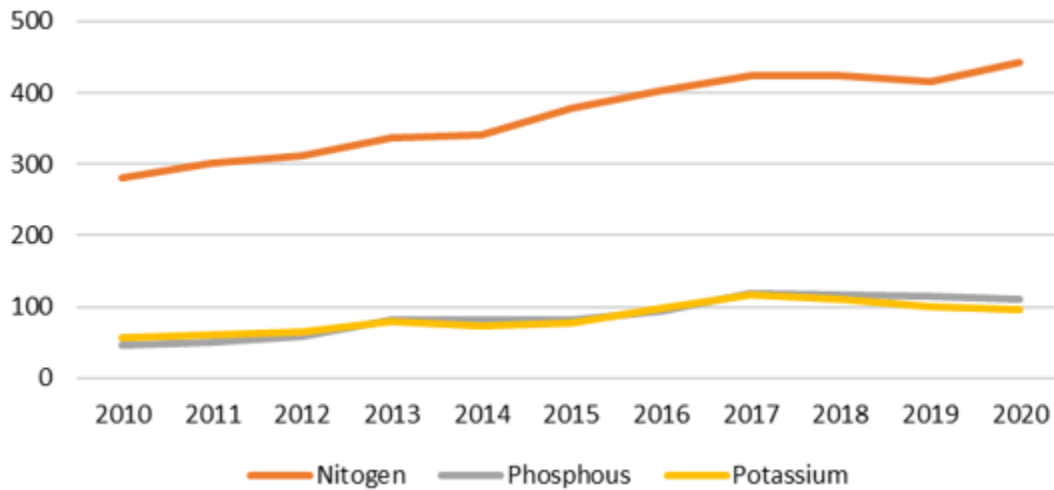

Figure 25. Distribution of fertiliser nutrients in the last 10 years [ktons]
Source: [5]

The different fertiliser feedstocks have appeared in different proportions over the years, but the **Figure 26** shows that nitrogen was present in more than 2/3 of the feedstocks in 2020. P and potassium are present in almost equal proportions, although the former is more dominant.

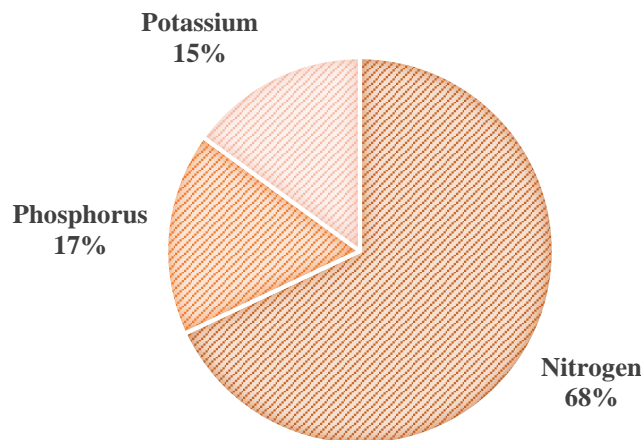

Figure 26. Primary composition of fertilizer sold in 2019 in Hungary
Source: [5]

An important measure of fertiliser use is the amount of fertiliser used per hectare of agricultural land. The distribution of this indicator over the last 10 years is shown in **Figure 27** below. This indicator has shown an almost continuous upward trend over the last 10 years. Furthermore, the 65 kg/ha used in 2010 doubled to 135 kg/ha in 2020.

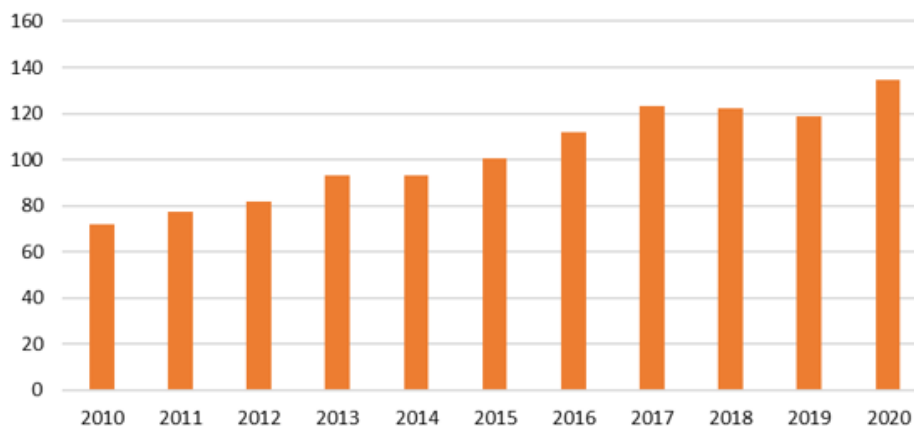

Figure 27. Total fertiliser used per hectare of agricultural area [kg]
Source: [5]

Soils contain a wide range of beneficial substances that are used and consumed by the agricultural industry through production and cultivation. In addition, the soil contains nutrients that are present in the form of salts, but cannot be used by vegetation without external intervention. The use of organic fertilisers or fertilisers has become widespread in order to ensure that arable land has adequate nutrient levels. The use of organic fertilisers or fertilisers involves the direct addition of a chemical/nutrient that increases the nutrient level of the soil. There is also a fertiliser/active substance that makes nutrients that are not in an absorbable state soluble through a chemical reaction [6]. The first method is the most widely used nowadays and the fact that the use of fertilisers is on the increase both at national and EU level has been described in several aspects in the previous paragraphs.

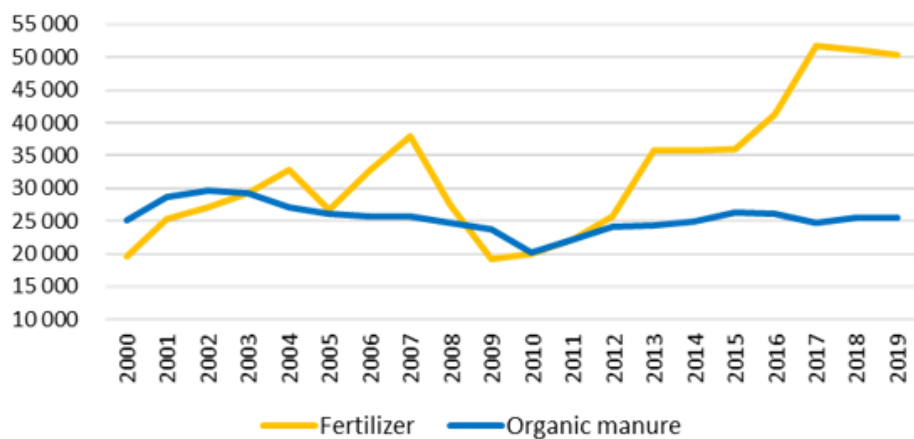

Figure 28. Change in P intake in Hungary 2000-2019 [tons]
Source: [7]

A P intake options in agriculture:

- fertilisation,
- organic fertilisation,
- other (propagating material).

The graph above (**Figure 28**) shows how soil P inputs have evolved over the past nearly 20 years for organic and fertiliser inputs. From this figure, the main evidence is the way in which the increased nutrient inputs have been managed. The organic matter was obviously managed in a limited and unpleasant way, but the increased demand was met by converting more fertiliser. Average annual P intake is 59.771 tons.

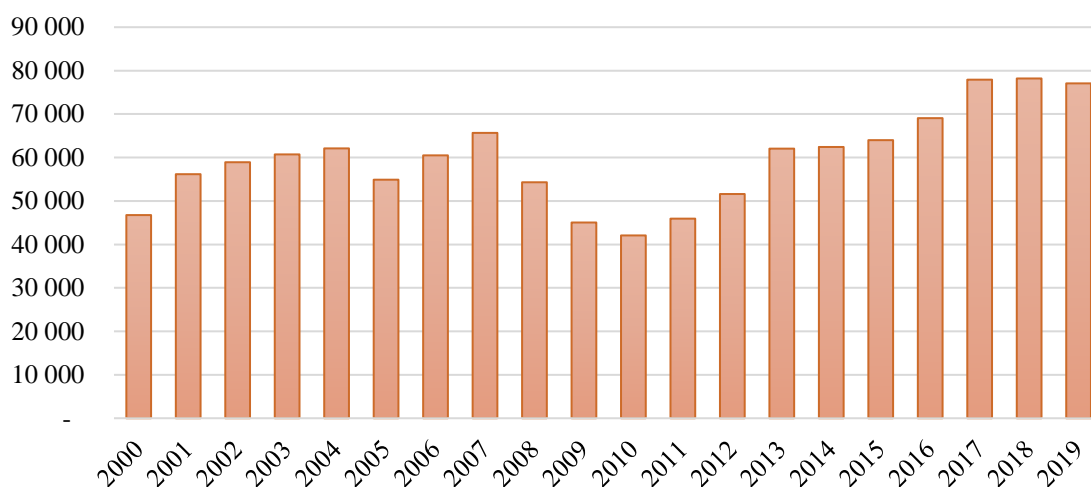

Figure 29. Change in P intake between 2000-2019 [tons]
Source: [7]

In the last 20 years, an average of 61 ktons of P has been applied annually in Hungarian agriculture. Of this, an average of 58% (35 ktons) comes from fertilizer application. In fact, in 2019, 65% of the total P input was from fertilization, 33% from organic fertilization and 2% from other propagation materials.

There is no significant leaching of P from the soil in the agricultural cycle and gaseous losses of P are almost negligible [8]. Thus, P outtake occurs through activities related to agriculture.

A P outtake options in agricultural:

- with harvested crops,
- fodder crops,
- plant by-products.

Overall P outtake has varied between 40 and 80 kilotons/year over the past 20 years, with varying intensity. The highest value was in 2016, but there was no major fluctuation in the data for the following 3 years (**Figure 30**). Average annual P outtake is 67.561 tons.

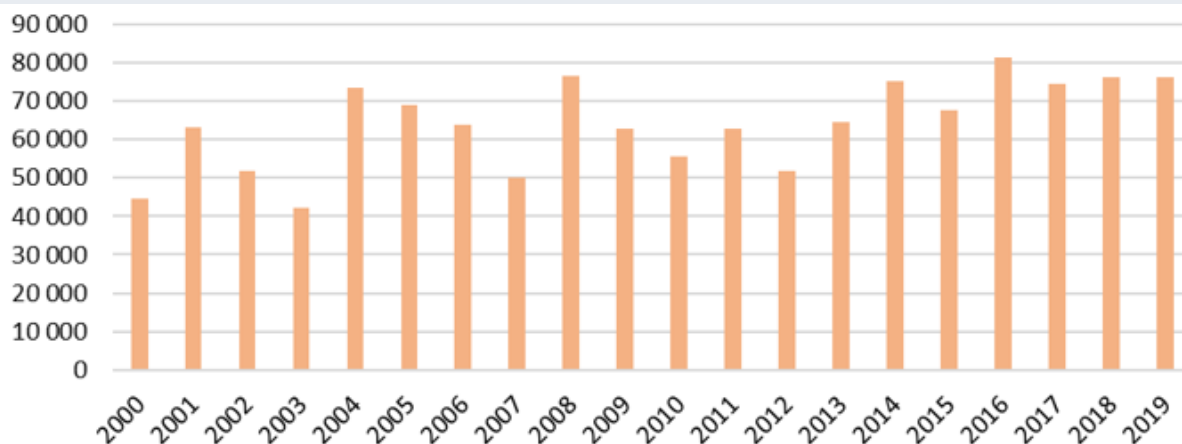

Figure 30. Change in P uptake between in 2000-2019 [tons]
Source: [7]

P uptake from agriculture is 90% from harvested crops. In addition, the harvesting of fodder crops accounts for only 10% of the distribution of P removal.

Phosphorus Balance Sheet in Hungarian Agriculture from the Last 20 Years

The amount of P remaining in the soil is estimated using a simplified soil nutrient balance (P balance – **Figure 31**).

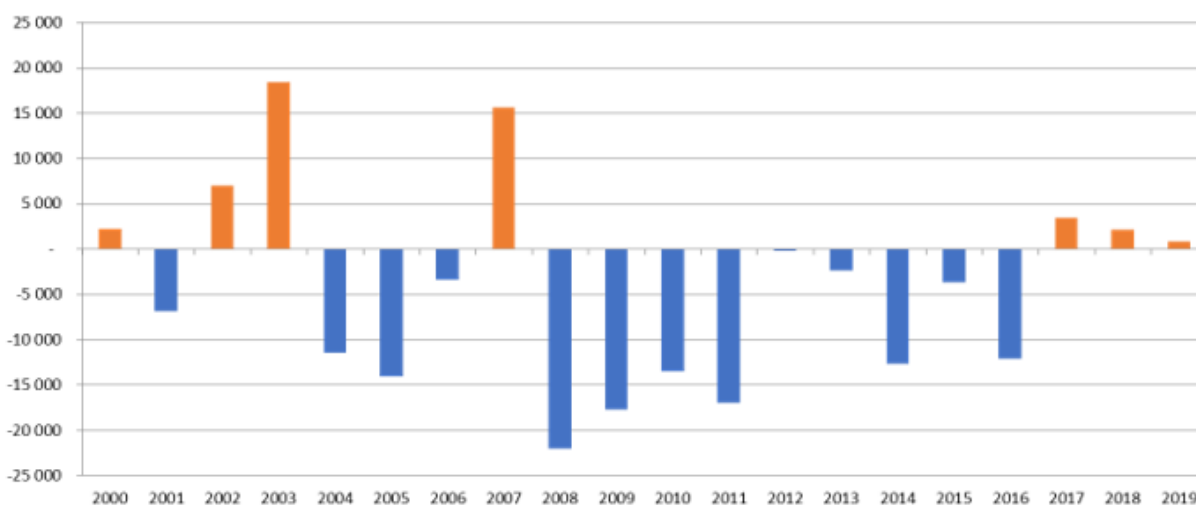

Figure 31. Phosphorus Balance Sheet in Hungarian Agriculture from the Last 20 Years [t]

The further fate of the amount of P fertilizer/organic fertilizer active ingredient in the soil is mainly influenced by the nutrient uptake of the crops. To take this into account, we use the concept and values of the P and potassium nutrient balance, which is calculated as the difference between the amount of fertiliser/organic fertiliser active ingredient applied to the soil and the amount of nutrient taken up by the crops. The amount of fertiliser active ingredient thus calculated and actually remaining in the soil can be used by the crops in later years, but its detectability may be influenced by other factors [9].

As can be seen, P outtake has been greater than intake over the last 20 years and there is a difference of 10-15% between the two values:

- average annual P intake is 59.771 tons,
- average annual P outtake is 67.561 tons.

It can be stated that increased fertilizer usage is foreseen in the next decades in Hungary.

3.3.4. Stakeholders involved in the flow of phosphorus raw materials in Hungary

Hungary's preeminent fertiliser partner network is called Genezis. This partner network includes 5 major companies (**Table 9**) [10].

Table 9. Genezis partner-network memberships

Company name	Company location	Year of foundation ¹	Website
Bige Holding KFT.	5000 Szolnok, Tószegi út 51.	1991	www.bigeholding.hu
Nitrogénművek Zrt.	8105 Pétfürdő, Hősök tere 14.	1931	www.nitrogen.hu
PÉTI NITROKOMPLEX Kft.	8105 Pétfürdő, Hősök tere 14.	1991	www.nitrokomplex.hu
Nádudvari Agrokémiai Kft.	Nádudvar	2004	www.nakft.hu
Nzrt-Trade Kft.	Nyíregyháza	2008	-

- Bige Holding Ltd.

Bige Holding Ltd. privatised the Tiszamenti Vegyiművek Rt. in 1997. Its legal predecessor, Tiszamenti Vegyiművek, was founded in 1951 to create the inorganic chemical industry centre of the Great Plain in Hungary. The investment started with the construction of a sulphuric acid plant. This was followed by the installation of a fertiliser plant, an inorganic pigment plant, a detergent plant, a cryolite plant and finally a phosphoric acid and tripolyphosphate plant. Following the investment in 2004, Bige Holding Ltd. now produces compacted NPK products from the Genesis fertiliser range, as well as sulphuric acid, phosphoric acid and cryolite.

The new fertilizer plant of Bige Holding Ltd. has been in operation since March 2004. The plant, which operates with compacting technology, produces reliably high-quality NPK and PK fertilizers without chemical reaction and drying process, with both meso- and micro-nutrient content in the quality required by the customer. The particle size and strength of the fertilisers produced meet today's modern European quality standards. The environmental impact of the new technology is minimal. The plant has a capacity of 140 kilotons/year [11].

¹ The year the company was registered or started production.

- Pétfürdő Nitrogénművek Zrt.

Pétfürdő Nitrogénművek Zrt. is today the only Hungarian nitrogen fertilizer company with ammonia and fertilizer production capacities, founded in 1931. The range includes nitrogen fertilizers, complex NPK fertilizers, foliar and nutrient fertilizers. The most important trademark of Nitrogénművek Zrt. is Pétisó, for which a patent application was filed on 28 June 1932. The main advantages of the product are that it can be applied to any crop, as a base and top dressing, reduces soil acidity, is easy to transport, store and apply. Chemical products and industrial gases generated during the fertiliser production process are also sold. The current market share of Nitrogénművek Zrt. in the domestic fertiliser market is about 60%. In recent years, the ratio of domestic and export sales of nitrogen fertiliser products has accounted for 50-50% of total sales. The main task of Nitrogénművek Zrt. is to meet the long-term demand for fertilisers in Hungarian agriculture [12].

- Péti Nitrokomplex Ltd.

Péti Nitrokomplex Ltd. is owned by Nitrogénművek Zrt, which was founded in 1991 by the self-establishment of the research and development part of the plant. The company's aim is to meet the needs of its customers and to adapt to the principles of environmentally friendly, integrated crop production, i.e. the rational supply of nutrients according to the area and the needs of the plant [13].



Figure 32. Pétfürdő is a centre of Hungarian fertilizers manufacturing



- Nádudvar Agrochemical Ltd.

The Nádudvar Agrochemical Ltd. and its predecessors have been operating a world-class state-of-the-art liquid fertilizer service system for more than 17 years. The plant specializing in liquid fertilizer production was built in 1986. It was then owned by Red Star Mg.Tsz. and later by HAGE. The primary objective of the agricultural plant is economic production, which has necessitated the application of state-of-the-art methods in the crop production sector. To achieve this goal, the founders created one of the most advanced liquid fertiliser plants of the time. The company's services include consultancy, transport, the setting up of transit depots, the provision of a group of application machines and the development of user technology [14].

- Nzrt-Trade Ltd.

Nzrt-Trade Ltd., based in Nyíregyháza, as a fertilizer supplier in the eastern part of Hungarian agriculture, as a member of the Bige Holding Group, continues today the trading activities that the predecessor company started in December 1991. It has a significant R&D activity in the production of fertilisers and has links with several research institutes and universities, which carry out the crop certification of its products and the basic research work necessary for their development [15].

- 3R-BioPhosphate Ltd.

3R-BioPhosphate Ltd. is a technologically advanced company that holds a prominent position globally in research and development, engineering, and complete industrialization of pyrolysis technology that produces zero emissions and its associated bio-products. One area of expertise for the company is the innovative retrieval of BioPhosphate, which contains a high nutrient density of 35% P_2O_5 , from animal bones suitable for food-grade applications. The company possesses unique knowledge and specialization in this field and is the sole EU center with such expertise [16].





References

- [1] Consultation Communication on sustainable use of phosphorus, www.eur-lex.europa.eu/legal-content/HU/TXT/PDF/?uri=CELEX:52013DC0517&from=HU
- [2] Agri-environmental indicator - mineral fertiliser consumption, www.ec.europa.eu/eurostat/statistics-explained/index.php?title=Agri-environmental_indicator_-_mineral_fertiliser_consumption
- [3] Hungarian Central Statistical Office (2020), www.ksh.hu/docs/hun/xftp/idoszaki/mezo/2020/index.html
- [4] Hungarian Central Statistical Office (2021), www.ksh.hu/agriculture
- [5] Hungarian Central Statistical Office (2020a), www.ksh.hu/stadat_files/mez/hu/mez0041.html
- [6] TOP PHOS – fenntartható foszfor management, www.hu.timacagro.com/2020/09/24/top-phos-fenntarthato-foszfor-management/
- [7] Hungarian Central Statistical Office (2020b), www.ksh.hu/stadat_files/mez/hu/mez0044.html
- [8] Hartman Mátyás Műtrágyázás NSZFI, www.nive.hu/Downloads/Szakkepzesi_dokumentumok/Bemeneti_kompetenciak_meresi_ertekelesi_eszkozrendszerenek_kialakitasa/5_3112_006_101030.pdf
- [9] Dr. Füleky György - Foszfor és kálium feltöltődése és kimerülése a talajokban www.agronaplo.hu/szakfolyoirat/2007/12/szantofold/foszfor-es-kalium-feltoltodese-es-kimerulese-a-talajokban
- [10] Genezis, www.genezispartner.hu/genezispartner/rolunk/
- [11] Bige Holding Kft. www.bigeholding.hu
- [12] Nitrogénművek Zrt. www.nitrogen.hu
- [13] Péti Nitrokomplex Kft. www.nitrokomplex.hu
- [14] Nádudvari Agrokémiai Kft. www.nakft.hu
- [15] Nzrt-Trade Kft. www.genezispartner.hu/genezispartner/rolunk/nzrt-trade-kft
- [16] 3R-BioPhosphate Ltd. <https://biophosphate.net/>



3.4. Slovakia

3.4.1. Introduction and framework

About Slovakia

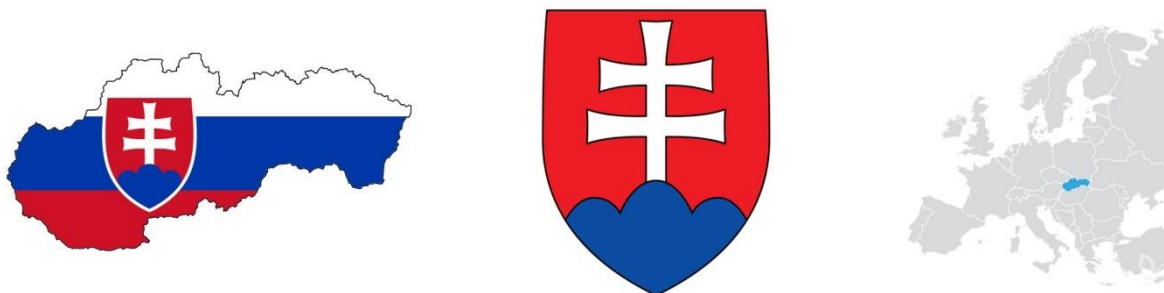

Figure 33. Slovakia

Source: [1]

Table 10. Information about Slovakia

Official name	Slovak Republic (SR)
State formation date	1 January 1993
State system	republic
Political system: parliamentary democracy	parliamentary democracy (150 members of Parliament elected for 4 years)
President	Zuzana Čaputová (since 15. 6. 2019), elected for 5 years
Prime Minister	Eduard Heger (since 2021)
State symbols	national coat of arms/emblem, national flag, state seal and national anthem „Nad Tatrou sa blýska“
Membership in international organisations	EU (since 1 May 2004), NATO, UN, UNESCO, OECD, OBSE, CERN, WHO, INTERPOL, etc.
International codes	SK, SVK, bar code 858
Area	49 035 km ²
Location	Central Europe (17° – 22° E, 47° – 49° N) The mid and the North of the country is mountainous (Carpathian curve), lowlands (important agricultural areas) are typical of the South and the East. The most important Slovak river the Danube connects the capital city of the SR Bratislava with two capital cities of the neighbour countries – Vienna and Budapest.
Time	Central European time (+1 hour from GMT) (Summer time/daylight – saving time from March to November: +2 hours from GMT)
Elevation	the highest point is Peak Gerlachovský štít (2655 m), the lowest point is the Bodrog river on village Streda nad Bodrogom (94 m)



Climate	Moderate climatic zone, with changing four seasons, average temperature in winter -2 °C (the coldest month January, the coldest area High Tatras), in summer 21 °C (the warmest months July and August, the warmest area Danubian Lowland). In some mountain ranges the snow remains on average 130 days per year
Border countries	Hungary (654.8 km), Poland (541.1 km), the Czech Republic (251.8 km), Austria (106.7 km), Ukraine (97.8 km)
Administrative divisions	8 self-governing regions (Bratislava, Trnava, Trenčín, Nitra, Žilina, Banská Bystrica, Prešov, Košice region), 79 districts, 138 towns, 2891 municipalities (including towns)
Capital city	Bratislava (population 465 327 as at 1/6/2012)
Population	5 412 008 (as at 30/6/2013)
Population density	110/ km ²

3.4.2. Phosphorus raw materials in Slovakia

P is a non-metallic element naturally occurring in the oxidation states - 3, + 3, but mainly + 5. In magmatic differentiation processes, P concentrates in basic gabbroid rocks which crystallize in the early stages. P, along with rare-earth elements and Nb, is found in alkali rocks and sedimentary phosphorites. Major P minerals comprise apatite, monazite and xenotime.

Apatite breaks down readily during weathering. P mobility in solution is moderate. The element is adsorbed on sediments rich in organic matter or precipitates with calcium and iron to form minerals such as vivianite. Phosphorite forms by the precipitation of calcium phosphate from seawater together with sediments and remains of organisms on the sea floor.

The world annual P production is about 2×10^8 tonnes. It is used mainly as fertilizer and as additive to detergents.

Large amounts of P are dispersed in the environment by agriculture (application of NPK-fertilizers), in wastewater, etc.

The average P content in stream sediments in Slovakia is $896 \pm 786 \text{ mg.kg}^{-1}$. The distribution of P is rather highly variable and presumably affected also by man-made dispersal. The most important possible natural sources of P are mainly alkali basalts, whose areal extent, however, is limited. For this reason, the biggest natural sources of P are other Neogene volcanics and granitoids. Anomalies over these lithotypes range from 1,100 to 3,000 mg.kg^{-1} P. Continuous zones with these values are typical of the crystalline units of the Tatricum and Veporicum,



metamorphosed rocks of the Gemericum and Central Slovakian Neovolcanics (**Figure 34**).

P contents in stream sediments of the Outer Flysch belt are fairly monotonous, ranging between 300 and 600 mg.kg⁻¹.

Anomalies with the lowest P values are associated with source areas dominated by Mesozoic carbonates. These source rocks and the associated stream sediments average a mere 0.04% P₂O₅.

The high and highest P contents in lowlands and intermontane basins are primarily man-made, due to agriculture, especially the application of NPK-fertilizers (**Figure 35**).

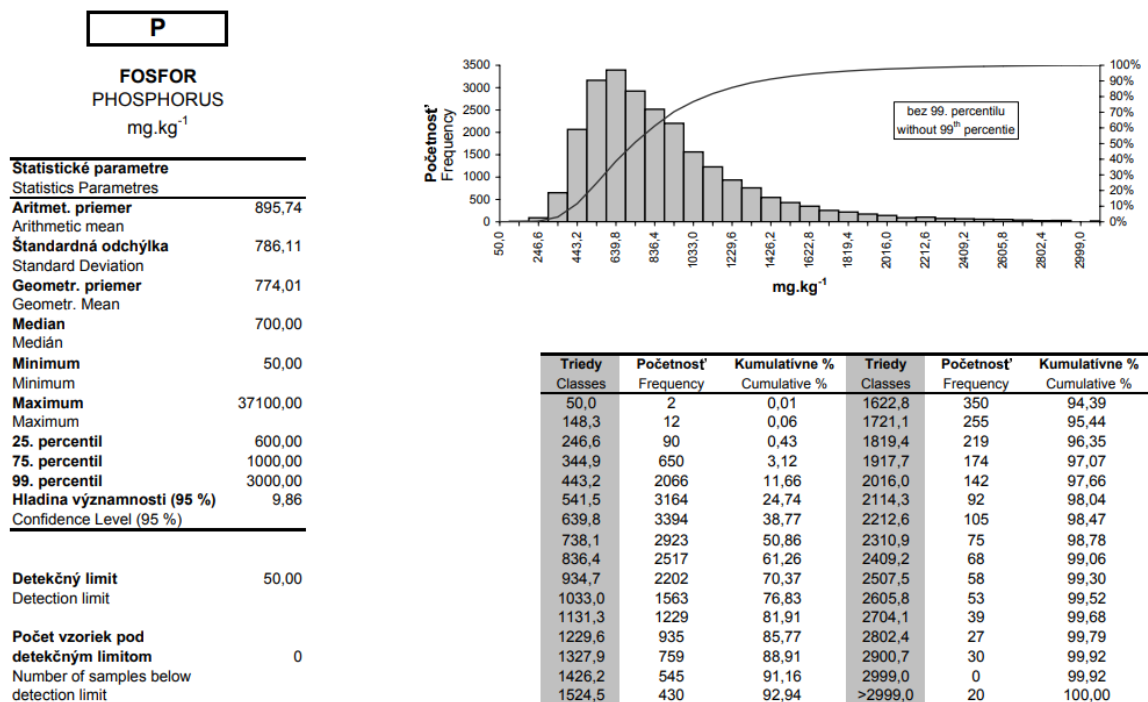

Figure 34. Statistical data of P in Slovakia

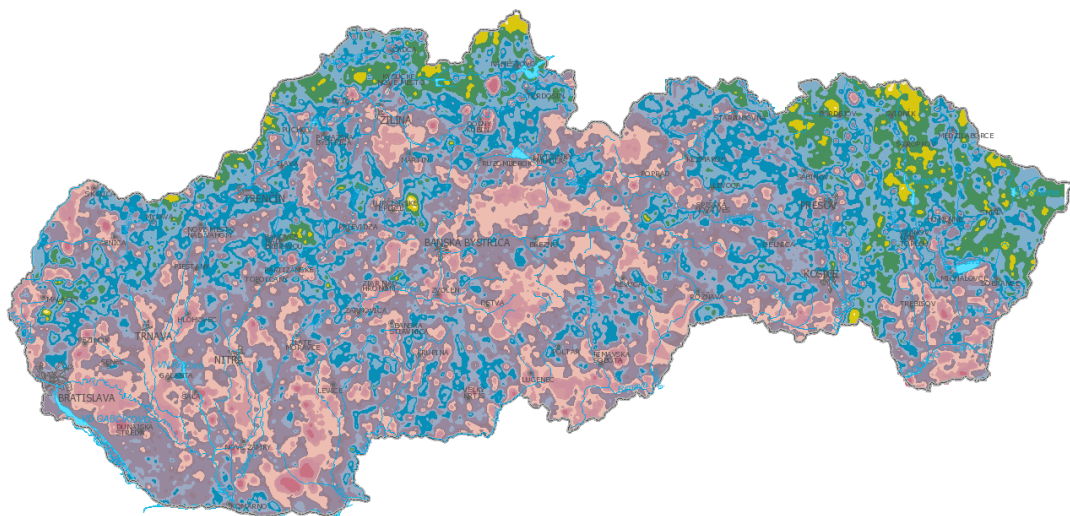

Figure 35. Geochemical atlas of Slovakia with P concentration in river sediments [mg/kg]

There is no P as a raw material mined at deposit. There is only one deposit in the south of Slovakia (**Figure 36**):

- locality: Gočaltovo,
- raw material type: phosphates,
- genetic type: Gemerida,
- stratigraphy: Paleozoic,
- application: production of phosphorous fertilizers.

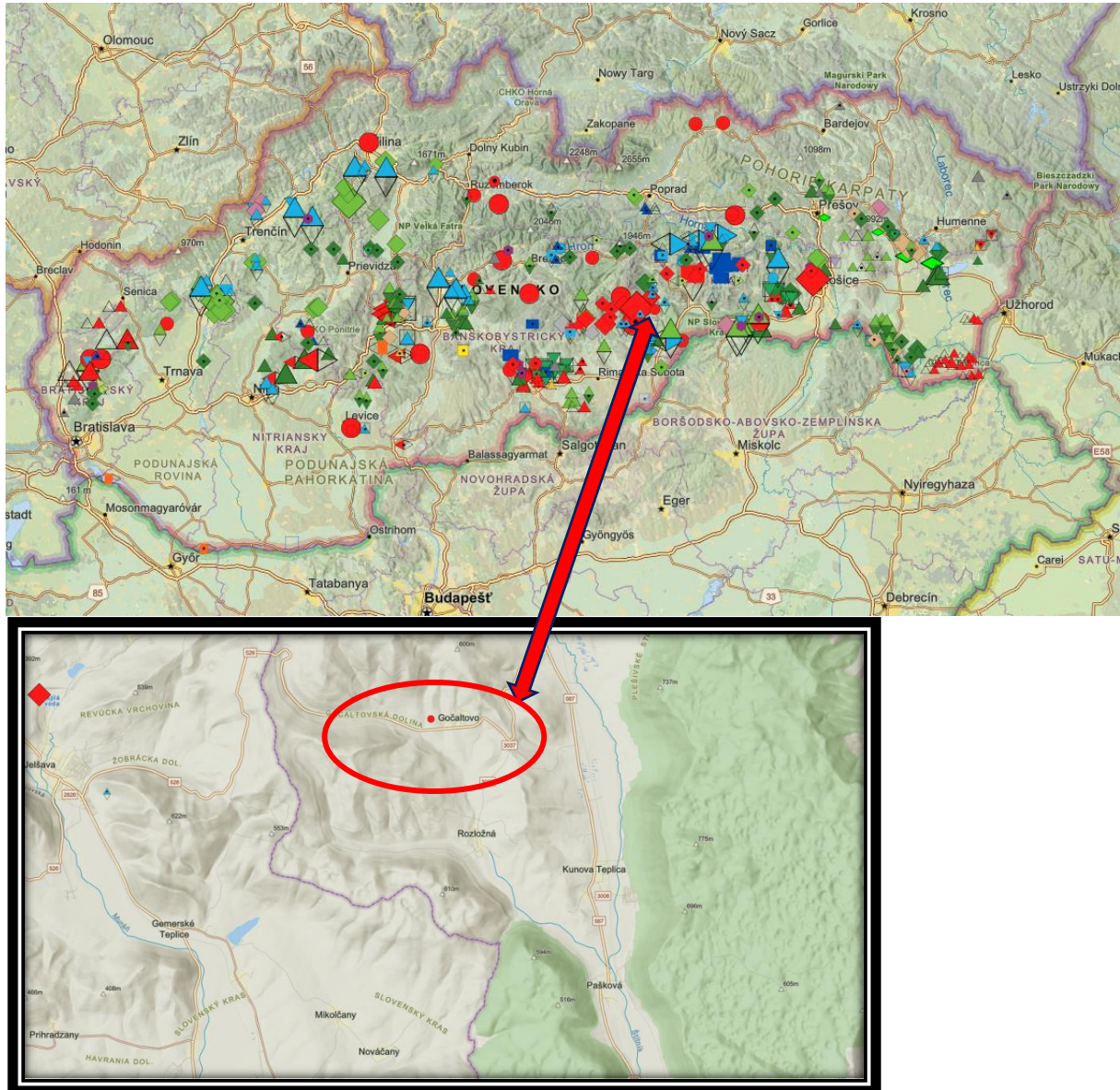

Figure 36. Deposit of P in Slovakia

Export and import

The import of P during the last 10 years to Slovakia is presented in **Table 11**. The largest amount of the P was imported in 2013, a total of 43,447.5 kg, and the lowest amount one in 2019, only 11 kg.

Table 11. Import of P to Slovakia in 2010-2019

Reporter	TradeFlow	ProductCode	Product Description	Year	Partner	Trade Value 1000USD	Quantity	Quantity Unit
Slovak Republic	Import	280470	Phosphorus	2010	World	4.73	170	Kg
Slovak Republic	Import	280470	Phosphorus	2011	World	2.69	100	Kg
Slovak Republic	Import	280470	Phosphorus	2012	World	6.12	237	Kg
Slovak Republic	Import	280470	Phosphorus	2013	World	294.44	43,447.5	Kg
Slovak Republic	Import	280470	Phosphorus	2014	World	6.33	212	Kg
Slovak Republic	Import	280470	Phosphorus	2015	World	37.33	2925	Kg
Slovak Republic	Import	280470	Phosphorus	2016	World	18.03	1353	Kg
Slovak Republic	Import	280470	Phosphorus	2017	World	19.12	1312	Kg
Slovak Republic	Import	280470	Phosphorus	2018	World	34.57	13,911	Kg
Slovak Republic	Import	280470	Phosphorus	2019	World	0.92	11	Kg

The most of P (**Figure 37**) was imported to Slovakia from Italy (68%) and Czech Republic (31%).

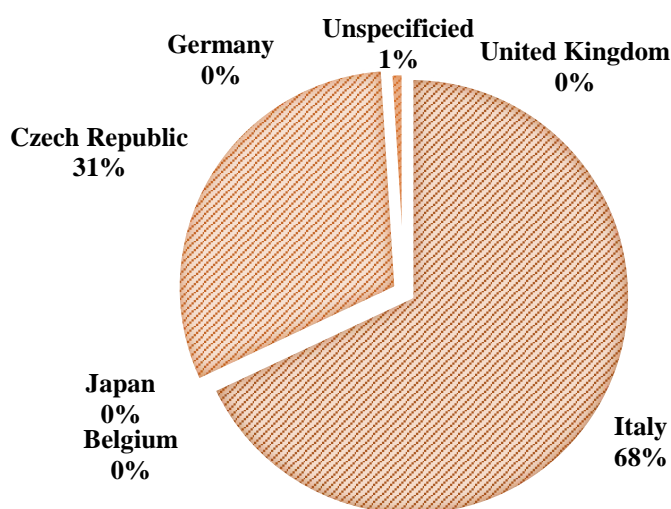

Figure 37. Import of P by country [%]

The export of P during the last 10 years from Slovakia to the world is presented in **Table 12**. The largest amount of the P was exported in 2010, a total of 65,212.5 kg, and the lowest amount in 2013, a total of 3780 kg. These are also the only years when P was exported from Slovakia.

Table 12. Export of P from Slovakia in 2010 and 2013

Reporter	TradeFlow	ProductCode	Product Description	Year	Partner	Trade Value 1000USD	Quantity	Quantity Unit
Slovak Republic	Export	280470	Phosphorus	2010	World	175.64	65,212.5	Kg
Slovak Republic	Export	280470	Phosphorus	2013	World	0.05	3780	Kg

The most of P (**Figure 38**) was exported from Slovakia to Hungary (95%) and Czech Republic (5%).

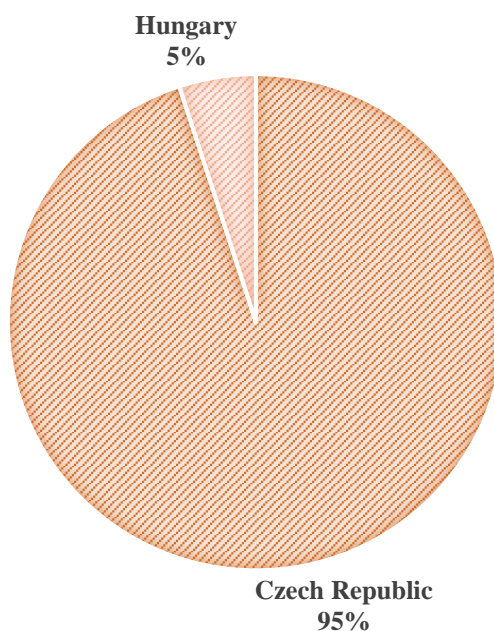

Figure 38. Export of P by country [%]

P in soil

In the evaluated period of the XII. cycle of agrochemical soil testing² (where the need of CaO is 360.5 thousand tons and consumption of CaO is 124.6 thousand tons), the national average P content in arable land was 68.7 mg P.kg⁻¹ which is at the level of a “satisfactory” supply category requiring the so-called replacement fertilization at the level of annual nutrient uptake by harvest. Compared to the previous cycle, there was a decrease of 7.2 mg P.kg⁻¹, which represents a decrease of 74.2 kg P₂O₅.ha⁻¹, i.e. 390 kg of simple superphosphate 19%.

² In Slovakia agrochemical soil testing is done in six-year cycles while the XII. cycle was 2006–2011.

Table 13. Percentage of available P categories from total area of arable land

Region	Low	Satisfactory	Good	High	Very high
Bratislava	39.45	34.68	18.87	4.3	2.7
Nitra	38.59	39.86	14.24	4.4	2.91
Trenčín	29.83	40	20.07	6.58	3.51
Trnava	44.64	36.01	14.05	3.17	2.14
Banská Bystrica	30.14	35.81	20.86	7.41	5.78
Žilina	19.08	28.32	29	13.93	9.67
Košice	38.12	33.07	16.46	6.68	5.67
Prešov	42.78	32.61	15.82	5.31	3.48
Total	282.63	280.36	149.37	51.78	35.86

Table 14. Percentage of available P categories from total area of hop gardens

Region	Low	Satisfactory	Good	High	Very high
Trenčín	13,36	9,44	16,74	21,54	38,92
Nitra	67,87	32,13	0	0	0
Total	81,23	41,57	16,74	21,54	38,92

Table 15. Percentage of available P categories from total area of vineyards

Region	Low	Satisfactory	Good	High	Very high
Bratislava	7,71	17,81	18,66	27,46	28,36
Nitra	30,94	37,54	17,71	6,38	7,43
Trenčín	91,01	0	0	0	8,99
Trnava	37,64	36,16	12,22	1081	3,18
Banská Bystrica	18,18	32,98	23,29	12,61	12,94
Žilina					
Košice	40,82	25,3	19,91	11,66	2,31
Prešov	47,46	0	52,54	0	0
Total	273,76	149,79	144,33	1139,11	63,21

Table 16. Percentage of available P categories from total area of orchards

Region	Low	Satisfactory	Good	High	Very high
Bratislava	1,41	14,1	21,74	47,87	14,88
Nitra	34,51	25,52	21,08	13,46	5,43
Trenčín	53,83	24,16	7,38	4,52	10,11
Trnava	66,6	19,86	10,22	1,44	1,88
Banská Bystrica	56,88	5,37	10,08	8,82	18,85
Žilina	18,29	11,67	6,97	0	63,07
Košice	63,17	18,98	6,7	6,22	4,93
Prešov	66,22	18,24	10	2,46	3,08
Total	360,91	137,9	94,17	84,79	122,23

Table 17. Percentage of available P categories from total area of grassland

Region	Low	Satisfactory	Good	High	Very high
Bratislava	17,8	23,37	34,57	5,21	19,04
Nitra	50,11	25,31	17,37	3,76	3,45
Trenčín	57,61	25,64	10,4	2,66	3,7
Trnava	37,82	27,73	16,26	8,15	10,04
Banská Bystrica	52,8	26,72	10,36	3,51	0,62
Žilina	55,76	23,33	9,97	2,87	8,07
Košice	51,45	23,89	13,55	4,96	6,16
Prešov	56,89	26,59	9,02	2,7	4,8
Total	380,24	202,58	121,5	33,82	55,88

Table 18. Percentage of available P categories from total area of farmland

Region	Low	Satisfactory	Good	High	Very high
Bratislava	37,39	33,59	19,63	5,13	4,27
Nitra	38,63	39,59	14,35	4,46	2,98
Trenčín	38,36	35,46	17,4	5,42	3,72
Trnava	44,49	35,63	14,08	3,39	2,4
Banská Bystrica	39,45	32,01	16,53	5,83	6,17
Žilina	43,14	25,05	16,51	6,67	8,63
Košice	41,55	30,7	15,71	6,26	5,78
Prešov	50,26	29,41	12,22	3,93	4,18
Total	333,27	261,44	126,43	41,09	38,13

Table 13 – Table 18 and Figure 40 represent a comparison of each type of soil in Slovakia and summary evaluation.

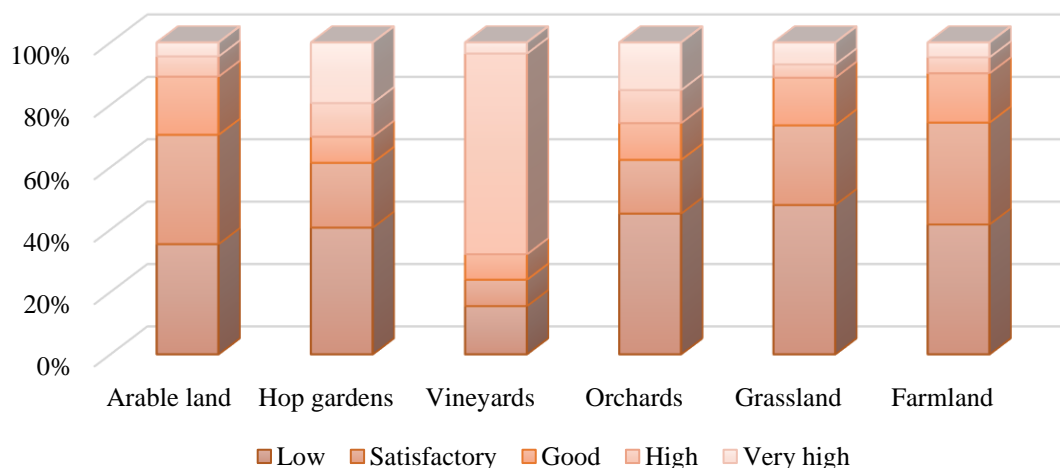

Figure 40. Summary evaluation of P content in soils in Slovakia

P in water

P is one of the most important macrobiogenic elements. It participates in all biochemical transformations in living organisms and natural waters. P compounds that

pollute water come mainly from sewage and animal waste (e.g. slurry, faeces, silage waste). An important inorganic source of water pollution by P compounds is agricultural land fertilized with industrial fertilizers. Increased supply of nutrients (in the form of P compounds) to the water can cause some organisms, especially green algae, and plankton, to multiply at the favour of others. Aquatic animals are not enough to consume huge algal biomass. Algae die, fall to the bottom and rot. As a result of excessive multiplication and decomposition processes, oxygen is pumped out of the water and toxic gases (sulfane and ammonia) are formed, which kill aquatic animals. The waters affected by this phenomenon change their colour to green and brown and smell unpleasant. This process is called eutrophication. Eutrophication can be prevented by limiting the fertilization of agricultural land, treating wastewater, planting plank-eating fish, aerating water, etc.

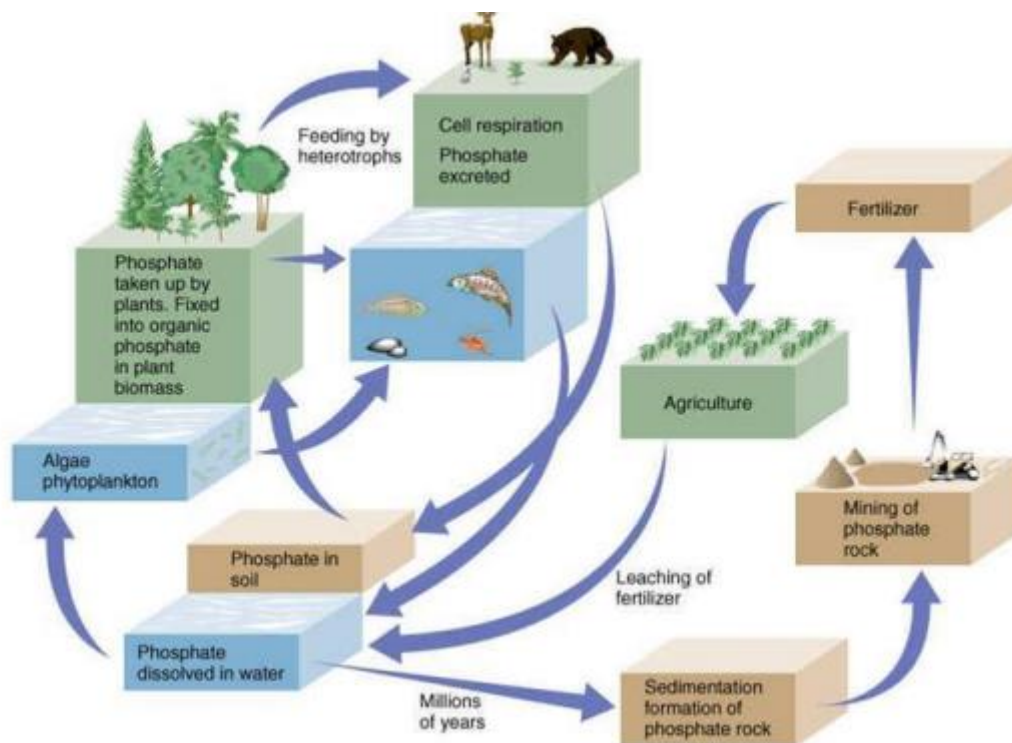

Figure 41. P cycle in water
Source: [2]

Phosphates do not contribute in any way to the taste or smell of the water and therefore do not pose a major problem for drinking water. However, high phosphate levels in wastewater can have a significant impact on the surrounding ecosystem. High levels of phosphates in the source water can accelerate the growth of some types of algae and plants, which can lead to eutrophication and flowering of algae. When this happens, fish and aquatic animals do not have enough oxygen, which increases fish mortality and damages the environment. The measurement of phosphates in wastewater is very important for maintaining

a healthy ecosystem and protecting animals. Many areas have strict phosphate discharge limits in place to protect the ecosystem into which such water flows. In addition to protecting the ecosystem, failure to monitor and regulate phosphate levels can lead to infringements and consequent fines. Water treatment plants that use phosphates to control corrosion should monitor the proportion of phosphates in the treated water, distribution system and other stages of the treatment process.

The total production of P by wastewater treatment plants is presented in **Figure 42**.

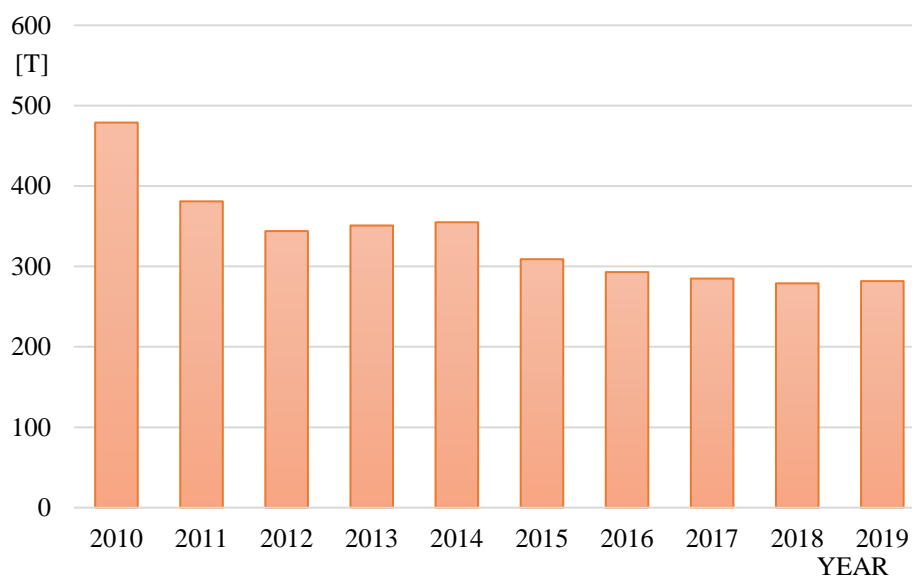

Figure 42. Production of P_{tot} by wastewater treatment plants in Slovakia

The basic monitoring of the Hornád River (**Figure 43**) was carried out in a sufficient number of surface water bodies in order to assess the overall status of surface water basins. In order to evaluate the quality of surface water in the basin of the Hornád River, three sampling points were selected – at the beginning of the flow in the village of Hranovnica, in the middle of the flow in the village of Malá Lodina and at the end the flow in the village of Hidasnémeti, at the point where the river leaves the territory of Slovakia. Based on the monitoring data parameters for assessing the quality of surface water were surveyed in these sampling points.

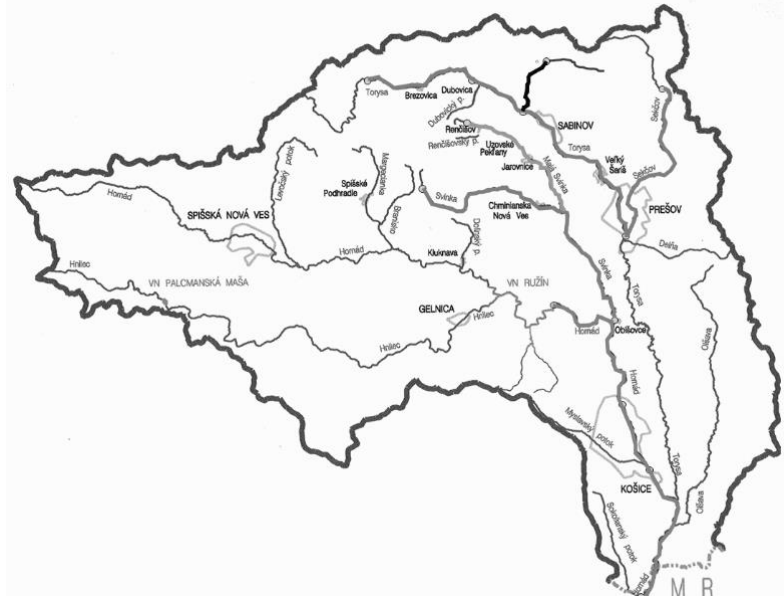

Figure 43. Graphical representation of Hornád River Basin

P_{tot} (Figure 44) – in the evaluation of the results of the analysis of the indicator total P the limit value was 0.4 mg/L. Slight exceedances of the limit occurred in the years 1995-1996 and 2001-2002 and significant exceedance occurred in the years 2003-2004, and an exceedance with an extreme value of 0.72 mg/L was reached in the biennium 1993-1994. Maximum exceedance with an extreme value of 0.97 mg/L was reached in 1993. The limits were only exceeded at the sampling site Hidasnémeti. In view of the development of the values of this indicator in the future steady state with of not exceeding the limit or slight and occasional exceeding of the limit value.

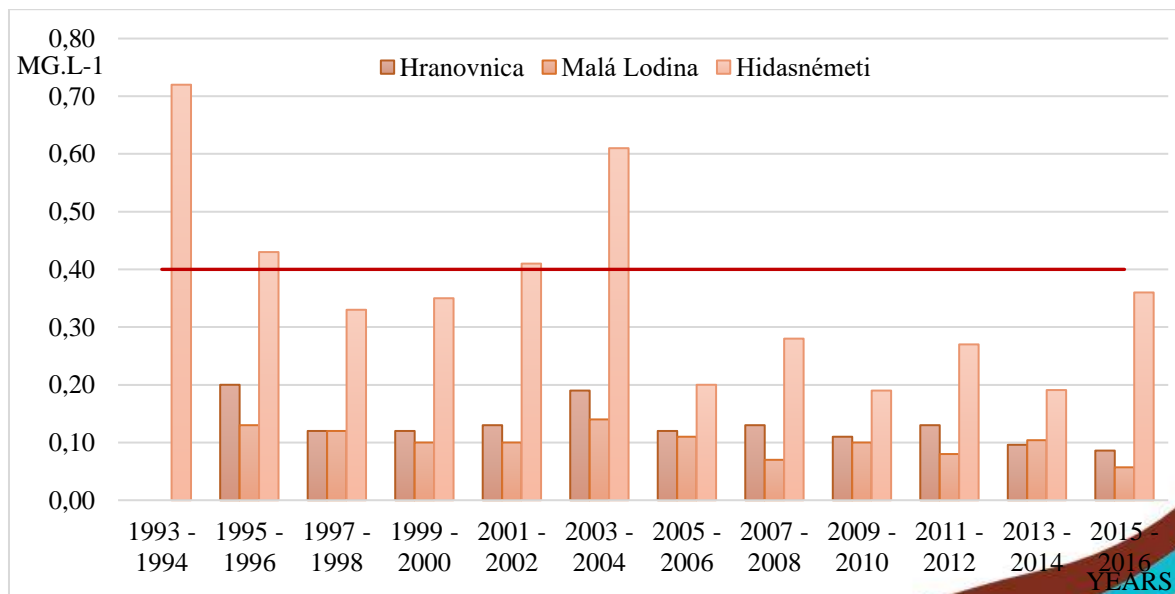

Figure 44. The progress of P_{tot} in the Hornád River

3.4.3. Use of phosphorus raw materials in food sector in Slovakia

In 2018, the consumption of industrial fertilisers containing NPK nutrients was at a level of 565,000 t, which was 29,000 t more than in 2017. The consumption of pure nutrients per hectare of agricultural land reached 102.4 kg NPK.ha⁻¹, i.e. 0.6 kg.ha⁻¹ more on a year-on-year basis. The consumption of fertilisers was applied to an acreage of 1,701,700 ha of agricultural land, which is 95.9% more than in 2017. In providing nutrition, nitrogen nutrition was favoured over phosphoric and potassium nutrition. The consumption of nitrogen accounted for 75.8 kg.ha⁻¹, the consumption of P pentoxide accounted for 15.1 kg.ha⁻¹ and the consumption of potassium oxide accounted for 11.6 kg.ha⁻¹. In 2018, the highest level of fertilisation was recorded in the case of potatoes. A positive balance of fertilisation was also achieved in the case of winter wheat, oilseed rape and spring barley. As for other crops, the NPK level was lower. A significant fertilisation deficit was recorded for grain maize and sugar beet. A smaller deficit was recorded for sunflower (**Figure 45**).

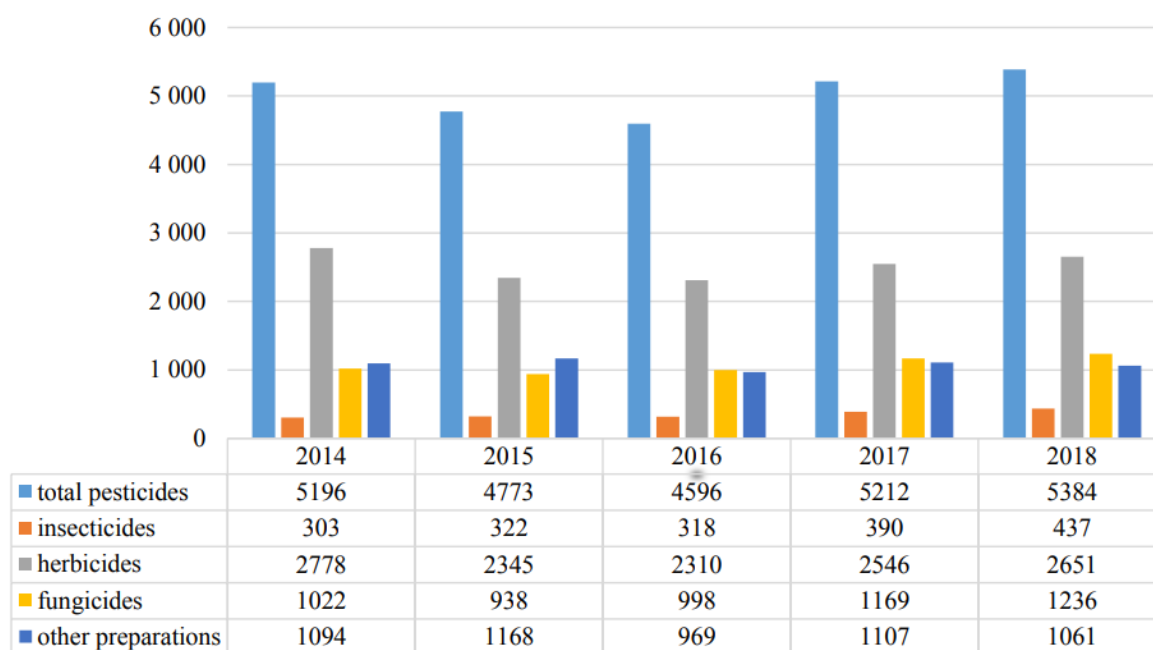

Figure 45. Progress of the NPK nutrients deficit on fertilised acreage (kg.ha⁻¹)

In 2018, the volume of all types of chemical preparations used for plant protection increased on a year-on-year basis by 172 t (3.3%) to 5,384 t, of which the consumption of insecticides increased by 47 t (12.1%) to 437 t, of herbicides by 105 t (4.1%) to 2,651 t and of fungicides by 67 t (5.7%) to 1,236 t. The consumption of other preparations (fungicidal mordants, insecticidal mordants, rodenticides and other preparations) decreased by 46 t (4.2%) to 1,061 t.

Herbicides accounted for 49.2% of all the pesticides used. Of those, the most frequently used

herbicides included amides (15.3%), phenoxy acids (10.0%) and dinitroanilines (7.9%). The share of fungicides in the consumption of protective preparations accounted for 23.0%. More than half of the fungicides used (53.5%) were thiazoles and diazoles. Insecticides accounted for 8.1% of the pesticides used. In this group, organic P compounds (51.2%) and pyrethroids (24.5%) were the most frequently used pesticides. The share of other protective preparations accounted for 19.7% of the plant protection preparations used. The insecticidal stains used accounted for 20.6% of this group, fungicidal mordants accounted for 12.9% and the least used preparations were rodenticides (1.2%). Of the other chemical plant protection preparations, the preparations used in the largest quantities were morphoregulation preparations (36.9%), desiccants and defoliant (13.7%) and pyrethroid mordants (19.8%).

In 2019 the consumption of seeds and plants in the case of selected crops (wheat, rye, barley, oat, maize, peas, oilseed rape and soya), compared to the previous year, increased by 1.1%, reaching a volume of 122,395,000 t. The most significant increase was recorded for the consumption of maize seeds, with a volume of 4,960 t (11.1%). The consumption of rye seeds increased to 31 t, which was 8.4% more on a year-on-year basis. There also was an increase in the consumption of soya seeds, with a consumption volume of 2,397 t (4.6%). There was a slight increase in the consumption of barley seeds, which increased to 25,377 t (1.9%) and the consumption of wheat seeds increased to 85,715 t (1.0%). The higher consumption of seeds of these crops is associated with the year-on-year increase in their sown areas. The greatest reduction in the consumption of seeds and plants was recorded for peas, whose consumption dropped to 1,910 t (13.8%), oat seeds consumption decreased to 2,563 t (9.2%) and the consumption of rape seeds decreased to 442 t (4.6%). In 2019, these crops were sown on a smaller area than in 2018 (**Figure 46**).

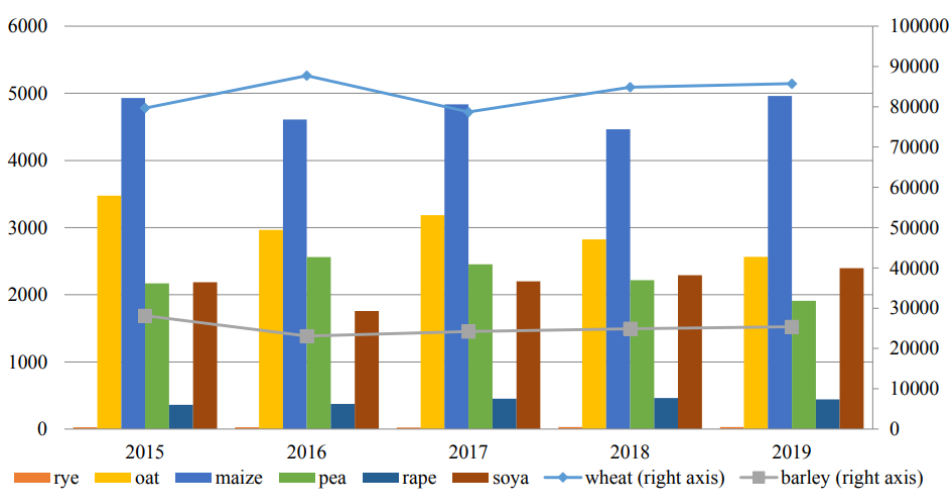

Figure 46. Development of the consumption of seeds and plants (t)

The use of P fertilizers is presented in **Figure 47**.

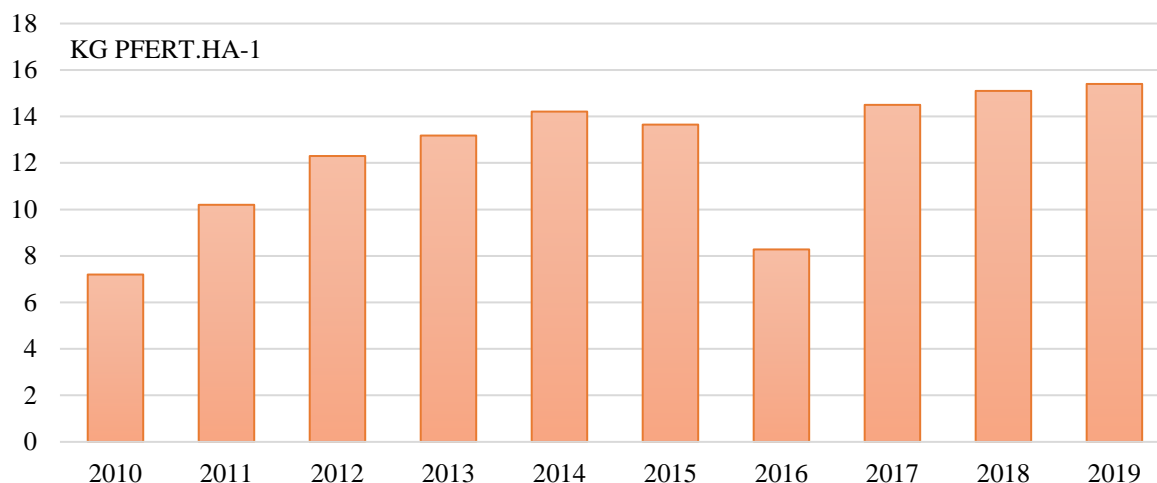

Figure 47. The use of P fertilizers in Slovakia

3.4.4. Stakeholders involved in the flow of P raw materials in Slovakia

The biggest company dealing with fertilizers is Duslo, a.s., a member of the AGROFERT Group. It is one of the most significant companies of chemical industry in Slovakia. It has developed into a manufacturer of fertilisers of European significance and a global supplier of rubber chemicals. It is a producer of polyvinyl acetate and polyacrylic glues and dispersions that it supplies to the global market. The company's product portfolio includes:

- industrial fertilisers,
- rubber chemicals,
- dispersions and glues,
- products of magnesium chemistry,
- special products.

The company is situated with its manufacturing units in the immediate vicinity of the town of Šal'a that is located in the Nitra region in the south of the western part of Slovakia, 65 kilometres from the capital city of the Slovak Republic – Bratislava. A part of manufacturing and service activities is performed in Bratislava (in the former complex of Istrochem that as of January 1, 2006, became a part of Duslo, a.s.).

Projects

- Major water management project – A new water project in the North-West of Slovakia will bring major benefits to thousands of EU citizens (more information can be found here: https://ec.europa.eu/regional_policy/et/projects/major/slovakia/major-water-management-project-makes-waves),



- Slovak Grant Agency for Science (Grant No. 1/0563/15). Research Project was carried out as planned research projects of the Department of Applied Ecology, Sumy State University, connected with subjects “Reduction of technogenic loading on the environment of enterprises of chemical, machine-building industry and heat and power engineering” according to the scientific and technical program of the Ministry of Education and Science of Ukraine (state registration No 0116U006606).

References

- [1] Slovakia.travel, www.slovakia.travel/en/about-slovakia/facts.
- [2] Carosella (2008), <http://www.ramp-alberta.org/river/gallery.aspx?galleryimage=1027>.
- [3] The Influence of Phosphogypsum Addition on Phosphorus Release in Biochemical Treatment of Sewage Sludge, www.ncbi.nlm.nih.gov/pmc/articles/PMC6025267/.
- [4] Duslo Šal'a a.s., www.agrofert.cz/en/our-companies/45/duslo-a.s.
- [5] Agriculture and Food Sector, www.mpsr.sk/en/index.php?navID=16&id=76.
- [6] Analytical factsheet for Slovakia: Nine objectives for a future Common Agricultural Policy, https://ec.europa.eu/info/sites/default/files/food-farming_fisheries/by_country/documents/analytical_factsheet_sk.pdf.
- [7] Výsledky agrochemického skúšania pôd na Slovensku v rokoch 2006 – 2011, www.uksup.sk/storage/app/uploads/public/5e1/cc5/897/5e1cc5897fd1e630610295.pdf
- [8] Geochemický atlas SR, www.apl.geology.sk/atlasrs/.
- [9] Geoportál ŠGÚDŠ, www.apl.geology.sk/mp2/#.
- [10] The Slovak Statistical Office.
- [11] Loch Branislav, Bakalár Tomáš, Róth Barbora (2017). Water quality assessment of River Hornád, Slovakia. In: Research Journal of Mining. Vol. 1, No. 2, 72-79.



4. Conclusion

Sustainable management of mineral resources is an important role in the proper functioning of European countries, including the V4 countries. Phosphorus is one of the most important elements that belong to the group of critical raw materials. Phosphorus cannot be replaced by another element. Moreover, phosphorus is an essential element of human nutrition. The problem is its resource constraints.

The V4 countries - Poland, the Czech Republic, Hungary and Slovakia do not have a P mine, and they satisfy the demand for P raw materials with imports. It is possible to replace the current imports of the V4 countries with raw materials from secondary sources, such as industrial wastewater, biomass, industrial waste and others. Moreover, the countries of the V4 countries have taken steps to broaden the knowledge of P raw materials among the society. Initiatives that disseminate information on P raw materials include organizations promoting innovative solutions for the extraction and sustainable management of P, or projects related to P raw materials in which countries participate. Such projects include "How to stay alive in V4? Phosphorus Friends Club builds V4's resilience", whose main goal is to increase the knowledge and awareness of the importance of P raw materials for food production in the Visegrad Group. The project also aims to develop a strategy for the sustainable management of P, which will contribute to ensuring a sufficient amount of P for food production. It also includes various awareness-raising events such as a workshop and a follow-up conference. Project products as a P management roadmap in V4 countries will accelerate the implementation of P recovery and ensure the safety of food production during and after the COVID pandemic. Such and similar initiatives may contribute to faster independence of the V4 countries from the import of phosphorus raw materials.

The project is co-financed by the Governments of the Czechia, Hungary, Poland and Slovakia through Visegrad Grants from International Visegrad Fund. The mission of the fund is to advance ideas for sustainable regional cooperation in Central Europe.

supported by

• **Visegrad Fund**
• •

