

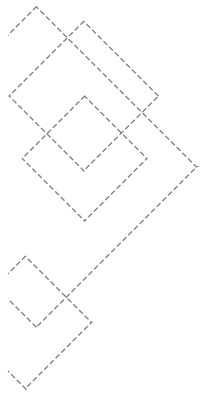

UPVC DOORS & WINDOWS HARDWARE

Inspired By Design, Powered By Quality





ABOUT COMPANY

PEGO is one of the leading and a pioneer Door & Window Hardware Brand in India. PEGO has created niche with focus on Aluminium & uPVC Door & Window Hardware. "Inspired by Design & Powered by Quality" – The Organization lives by this Tagline & it is integral to the ethos of the company.

PEGO Hardware through its reach, diversity & innovations has made enormous strides in setting trends, benchmarks, redefining and creating strong niche in the Indian fenestration industry over a decade. The Company has already executed many Private, Government & Institutional Projects across the country.

PEGO has complete range of Aluminium & uPVC door & window hardware covering:

Casement Door Hardware

Sliding Door Hardware

Casement Window Hardware

Sliding Window Hardware

The USP of PEGO is its ability to address the need of the industry and various stakeholders with respect to hardware solutions through its range of innovative and premium products. It is for this reason company has enjoyed patronage over the years of Developers, Architects, Consultants & Door and Window Manufacturers.

PEGO with its extensive growth has managed its presence on PAN India basis through its sales team and Branch Offices cum Warehouses. The company boasts of state of the art facility with testing laboratory. At its head office, PEGO has created first of its kind Application Centre by a hardware company in fenestration Industry in India with the display of new innovative hardware products & their application. The Company has its In-House R&D Lab fully equipped to measure product cycle testing, powder coating thickness, material composition enabling it to deliver premium quality products with 10 years warranty. All products are backed up with all the requisite certifications from internal & external laboratories.

PEGO under the leadership of its founder Mr. Karan Shah – Foster the team with zeal, thrive and passion leading them to become the company to be "Partner of Choice..!" on a National Level.

TEST CERTIFICATES

SPECTRO
Analytical Labs Limited
CIN:U74220DL1998PLC092698

TEST REPORT

ZINC ALLOY

Date: 06-Aug-19 07:43 PM Program: Zn-60-X
Sample ID: ID-D190806018-1 Comment: Zn Alloy

Element	%	Test Method
Zinc	95.77	SOP/CHE/00-Zn
Aluminium	3.56	--do--
Copper	0.630	IS 2599:1983 (RA 2000)
Magnesium	0.007	SOP/CHE/00-Zn
Cadmium	0.0002	--do--
Iron	0.010	IS 2599:1983 (RA 2000)
Indium	0.0001	SOP/CHE/00-Zn
Nickel	0.0090	--do--
Lead	0.0074	--do--
Tin	0.0001	--do--
Thallium	0.0001	--do--

SPECTRO
Analytical Labs Limited
CIN:U74220DL1998PLC092698

TEST REPORT

STAINLESS STEEL

Date: 06-Aug-19 04:12 PM Program: Fe-30-X
Sample ID: ID-D190806018-2 Comment: SS/Fe

Element	%	Specified	Conformity	Test Method
Carbon	0.044	0.080 Max	Yes	ASTM E-1086-2014
Silicon	0.379	0.750 Max	Yes	--do--
Manganese	1.10	2.00 Max	Yes	--do--
Sulphur	<0.005	0.030 Max	Yes	--do--
Phosphorus	0.0310	0.045 Max	Yes	--do--
Chromium	16.51	16 Min - 20.00 Max	Yes	--do--
Nickel	8.08	8 Min - 10.50 Max	Yes	--do--
Nitrogen	0.045	0.100 Max	Yes	SOP/CHE/00-SS

Remark: Sample Conforms to Grade AISI304 with respect to above test.

SPECTRO
Analytical Labs Limited
CIN:U74220DL1998PLC092698

TEST REPORT

ALUMINIUM ALLOY

Date: 08-Aug-19 07:48 PM Program: Al-10-X
Sample ID: ID-D190806018-4 Comment: Al1-Alloy

Element	%	Test Method
Copper	0.620	ASTM E1251-2011
Magnesium	0.250	--do--
Silicon	6.54	--do--
Iron	0.650	SOP/CHE/00-AL
Nickel	0.019	ASTM E1251-2011
Manganese	0.374	--do--
Zinc	0.446	--do--
Lead	0.024	SOP/CHE/00-AL
Tin	0.012	--do--
Titanium	0.033	ASTM E1251-2011
Chromium	0.016	--do--
Vanadium	0.011	--do--

SPECTRO
Analytical Labs Limited
CIN:U74220DL1998PLC092698

SALT SPRAY TEST REPORT

TEST RESULTS

During each observation, indicate the number of parts with (A). The sum of each column should correspond to the total number of parts for the test.

A	B-appearance of white rust										C:white rust over more than 5% of the surface										D-appearance of red rust														
	0	1	2	3	4	5	6	7	8	9	10	0	1	2	3	4	5	6	7	8	9	10	0	1	2	3	4	5	6	7	8	9	10		
D																																			
C																																			
B																																			
A																																			
Hours	24	48	72	96	120	SUNDAY					144	168	192	216	240	264	SUNDAY					288	312	336	360	384	408	SUNDAY					432		
Date	09-08	10-08	11-08	12-08	13-08	SUNDAY					14-08	15-08	16-08	17-08	18-08	19-08	20-08	SUNDAY					21-08	22-08	23-08	24-08	25-08	26-08	SUNDAY					27-08	
D																																			
C	X	X	X	X	X	X	X	X	X	X	SUNDAY					X	X	X	SUNDAY					X	X	X	X	X	X	SUNDAY					X
B																																			
A																																			
Hours	456	480	504	528	552	SUNDAY					576	600	624																						
Date	30-08	31-08	01-09	02-09	03-09	SUNDAY					04-09	05-09	06-09																						
Appearance of White Rust	120 / 144 Hours										624 Hours										624 Hours														
TEST RESULTS	COMPLIES <input checked="" type="checkbox"/> DOES NOT COMPLY <input type="checkbox"/> %																																		
Note/Not: The test chamber is opened at 17 th hours everyday for test piece checking and replacement.																																			
Comments:	after 120 Hours first White Rust Appearance after 144 Hours more than 5% White Rust after 624 Hours first Red Rust Appearance																																		

SPECTRO
Analytical Labs Limited
CIN:U74220DL1998PLC092698

TEST REPORT

ID No- D190806018-4

Thickness of Coating

S. N.	Test Parameter	Result	Test Method
1.	Thickness of Powder Coating	90 - 95 micron	IS:6012-1992 (RA-2010)

SPECTRO
Analytical Labs Limited
CIN:U74220DL1998PLC092698

TEST REPORT

ID-D190806008-3

Thickness of Coating

S. N.	Test Parameter	Result	Test Method
1.	Thickness of Zinc Coating	14.5 micron	IS:1573-1986



RANGE OF PRODUCT

1.	SYSTEM HARDWARE CONFIGURATION	6-10
2.	CASEMENT WINDOW HANDLES	11-13
3.	SYSTEM HARDWARE	14-17
4.	CASEMENT DOOR HANDLES	18-21
5.	HINGES	22-25
6.	ESPAGES	26-29
7.	STRIKERS	30-31
8.	SHOOTBOLTS	32-33
9.	DOOR LOCKS	34
10.	SLIDING ROLLERS	35-39
11.	TRANSMISSION HANDLES	40-42
12.	POP UP HANDLES	43-44
13.	SLIDING ACCESSORIES	45-46
14.	LOCKABLE SLIDING HANDLES	47-49
15.	PREMIUM D HANDLES	50-52
16.	SLIDING TOUCH LOCKS	53-54
17.	SLIDING TOUCH LOCK STRIKER	55
18.	FRICTION STAYS	56-58
19.	PLASTIC ACCESSORIES	59



COLOUR OPTIONS:



WHITE



BLACK



BROWN



SILVER



GOLDEN

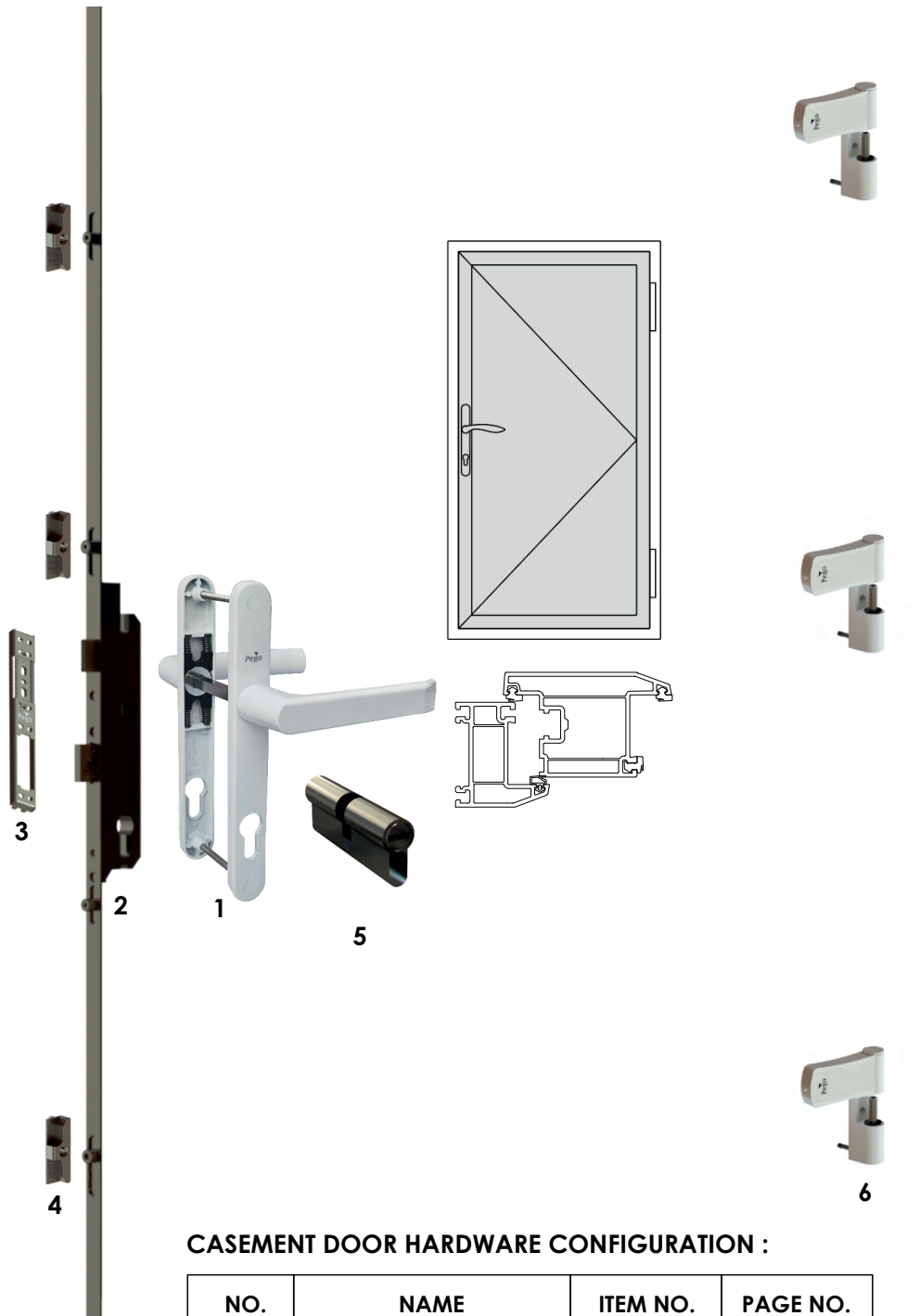

HANDLE OPTIONS



HD 22P



HD 22-AS



HD 22-SN



HD 22T

CASEMENT DOOR HARDWARE CONFIGURATION :

NO.	NAME	ITEM NO.	PAGE NO.
1	CASEMENT DOOR HANDLE	HD 30	19
2	CASEMENT DOOR ESPAGE	CDG	29
3	LOCK COUNTER PLATE	CP 11	34
4	CASEMENT DOOR STRIKER	CDK 01	31
5	CYLINDER WITH ULTRA KEYS	CY-85	28
6	3 D HINGE	BH 12-90	23

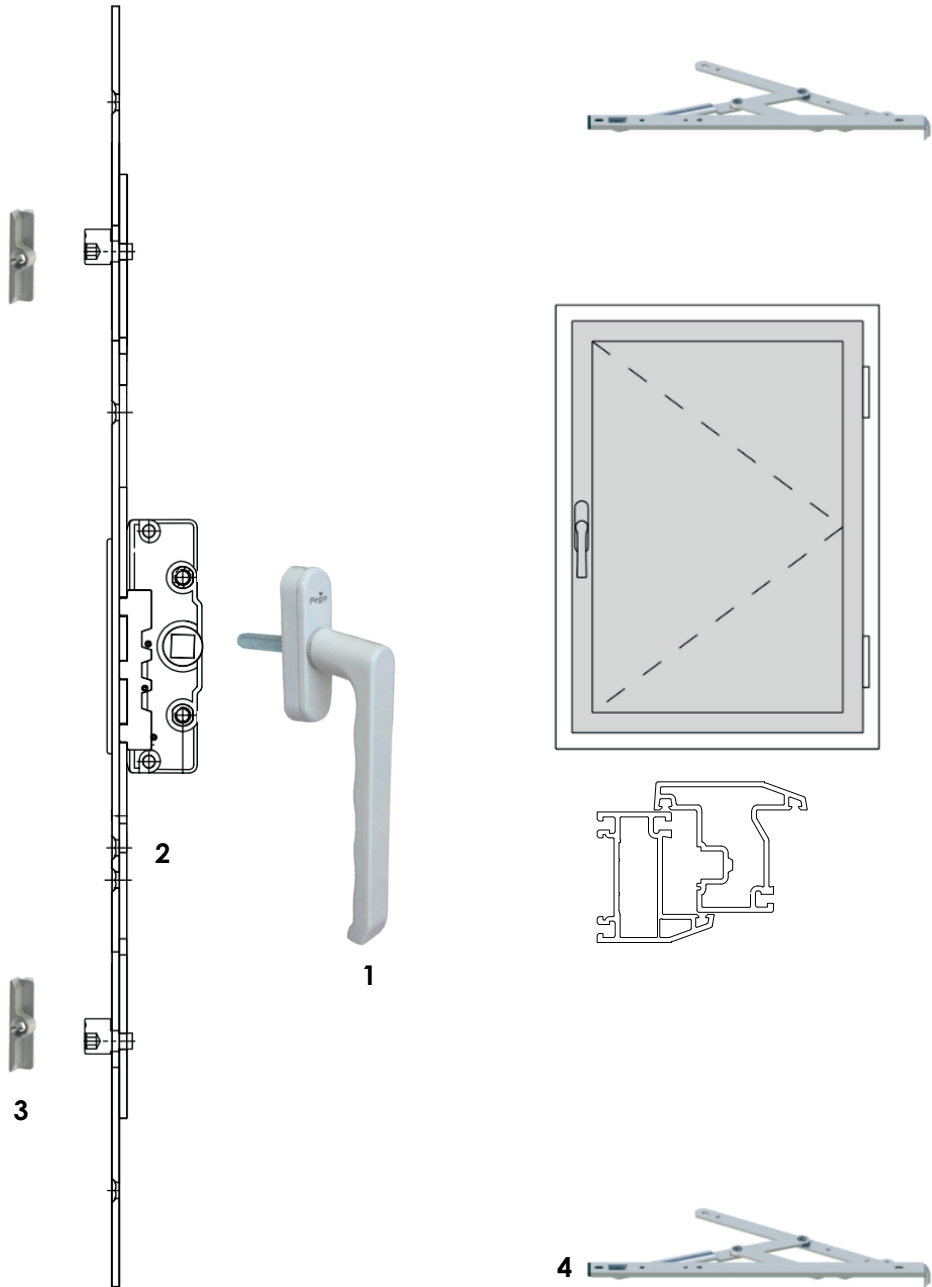

HANDLE OPTIONS



HD 33



HD 37



HD 35B



HD 43



HD 102

CASEMENT WINDOW HARDWARE CONFIGURATION :

NO.	NAME	ITEM NO.	PAGE NO.
1	CASEMENT WINDOW HANDLE	HD 40	12
2	CASEMENT WINDOW ESPAGE	CWG	27
3	CASEMENT STRIKER	CWK 01	30
4	SS FRICTION STAY	FS	57

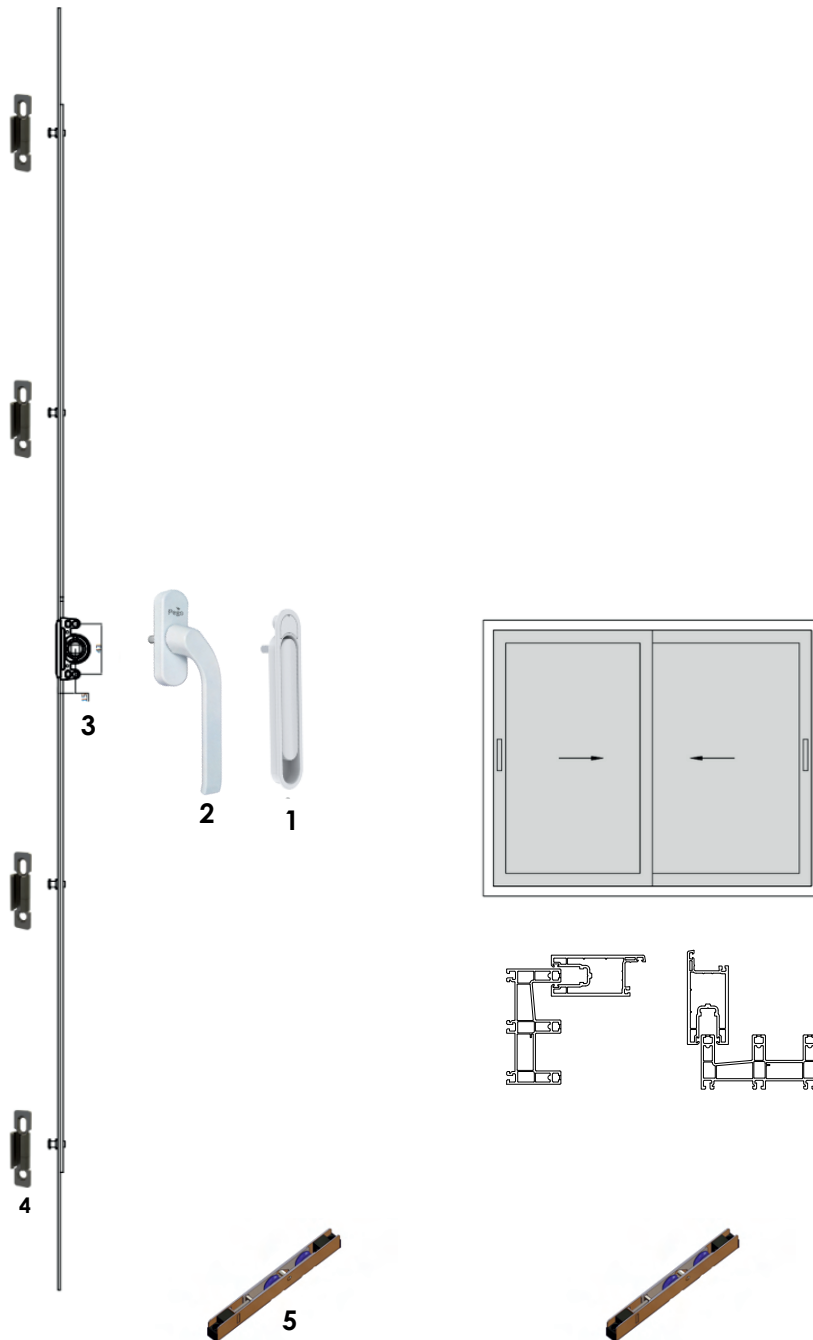

HANDLE OPTIONS



SL 38



SL 50 N



SL 47



SL 47K

SLIDING DOOR HARDWARE CONFIGURATION :

NO.	NAME	ITEM NO.	PAGE NO.
1	SLIDING POP UP HANDLE	SL 48	44
2	SHORT NECK DOOR HANDLE	SL 203	42
3	SLIDING DOOR ESPAGE	SDG	27
4	SLIDING STRIKER	SWK 02	31
5	ADJUSTABLE DOOR ROLLER	SR 24	38



HANDLE OPTIONS

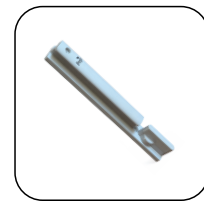

SL 111



SL 33D

SLIDING DOOR HARDWARE CONFIGURATION :

NO.	NAME	ITEM NO.	PAGE NO.
1	SLIDING LOCKABLE PATIO HANDLE ON BOTH SIDES	SL 211+ SL 212	51
2	SLIDING DOOR ESPAGE	SDGS	28
3	SLIDING ZINC ANTLIFT STRIKER	SWK 04	31
4	CYLINDER CAP	CAP 36D	21
5	CYLINDER WITH ULTRA KEYS	CY 60	28
6	ADJUSTABLE DOOR ROLLER	SR 30	39

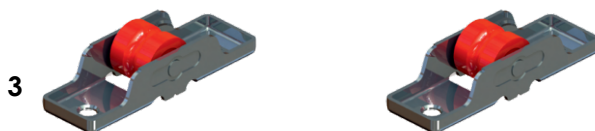
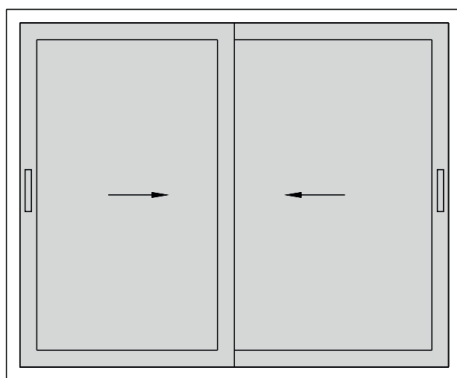

HANDLE OPTIONS

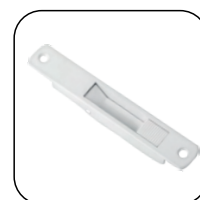

SL 31A

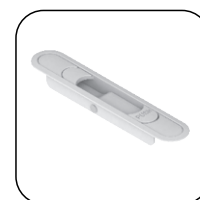

SL 42



SL 52

SLIDING WINDOW HARDWARE CONFIGURATION :

NO.	NAME	ITEM NO.	PAGE NO.
1	SLIDNG TOUCH LOCK	SL 31F	54
2	TOUCH LOCK KEEP	TLK 01	55
3	SINGLE WHEEL NYLON ROLLER	SR 21 PVC	36

CASEMENT WINDOW HANDLE



CASEMENT
WINDOW HANDLE

HD 33

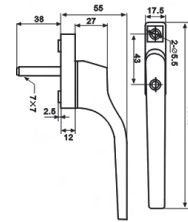

CASEMENT
WINDOW HANDLE

HD 37

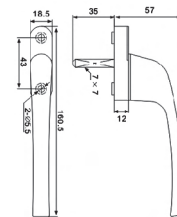

CASEMENT
WINDOW CRANK HANDLE
(LEFT/ RIGHT)

HD 43

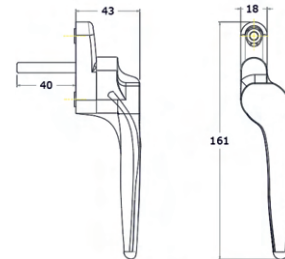

CASEMENT
WINDOW LUXURY
HANDLE

HD 40

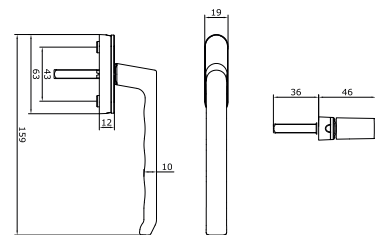

CASEMENT
WINDOW HANDLE
WITH KEY

HD 35B

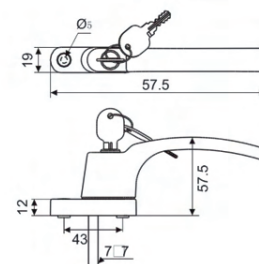

CASEMENT
WINDOW CRANK HANDLE
(LEFT/ RIGHT)

HD 102

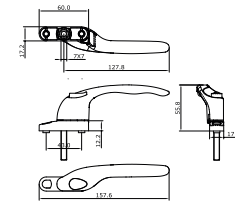

COCKSPUR HANDLE
(LEFT/RIGHT)

HD 42

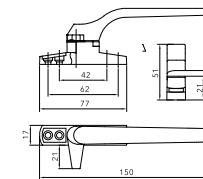

COCKSPUR HANDLE
(LEFT/RIGHT)

HD 48

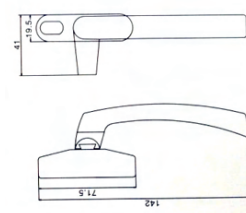

COCKSPUR HANDLE
(ECO SERIES)
(LEFT/RIGHT)

HD 09

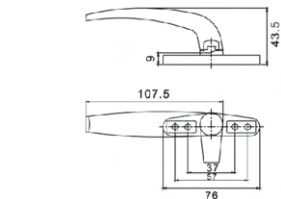

COCKSPUR HANDLE
(LEFT/RIGHT)

HD 42 - INW

Inward hook

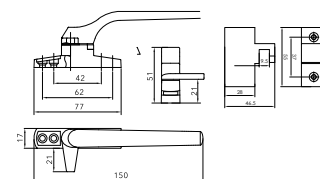



SLIDING FOLDING SYSTEM



SLIDING FOLDING SYSTEM

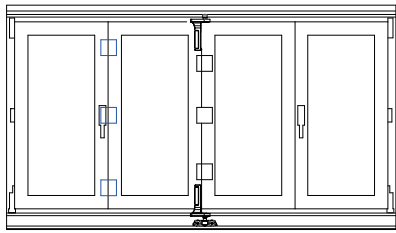

TECHNICAL SPECIFICATIONS:

- ▶ Shutter Weight Capacity: 80 Kgs
- ▶ Maximum Sash Width: 900mm
- ▶ Maximum Sash Height: 2400mm
- ▶ Maximum Aluminium Track: 6 Mtrs
- ▶ Colour Options: White & Ral 8022

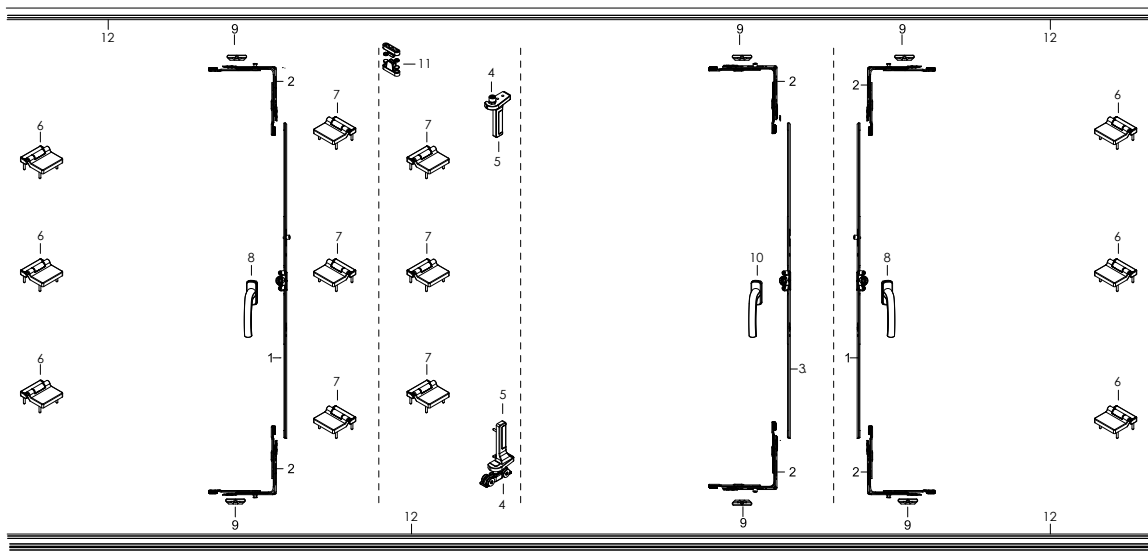
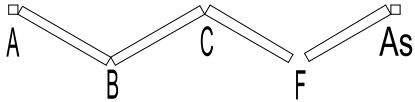

S. NO.	DISCRIPTION	S. NO.	DISCRIPTION
1.	DOOR ESPAGE WITH PIN	7.	FOLDING HINGE 30+50
2.	CORNER TRANSMISSION	8.	SLIDING LONG HANDLE
3.	DOOR ESPAGE WITHOUT PIN	9.	STRIKER 13MM
4.	BOGEY SET	10.	SLIDING ZERO HANDLE
5.	BOGEY BRACKET	11.	SASH CATCHER
6.	FOLDING HINGE 20+50	12.	CATCHER

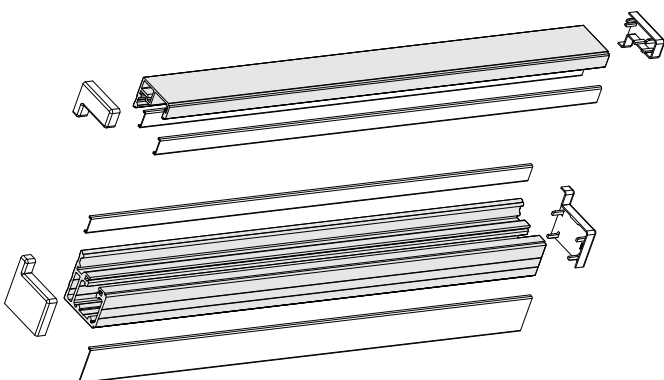

55MM THRESH HOLD

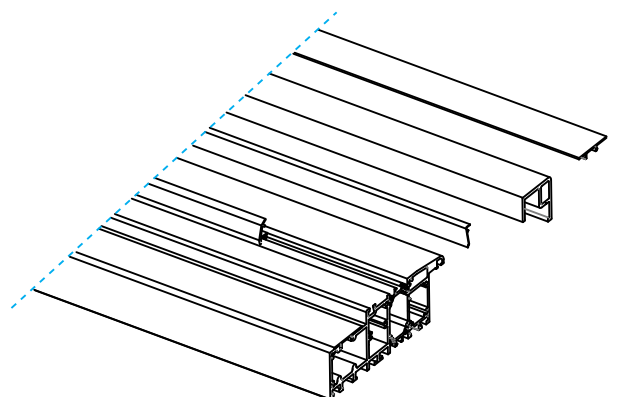

LOW THRESH HOLD

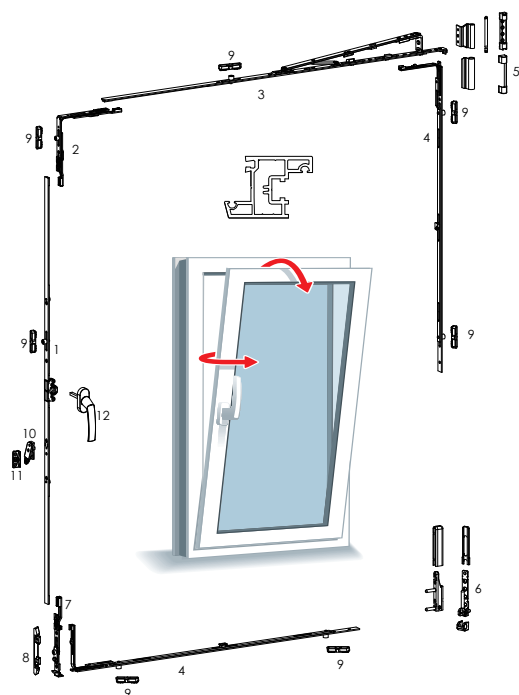

TILT & TURN CONFIGURATION

S. NO.	DISCRIPTION
1.	INWARD OPENING ESPAGE
2.	CORNER TRANSMISSION
3.	STAY ARM
4.	MIDDLE LOCK
5.	TOP HINGE SET
6.	BOTTOM HINGE SET
7.	BOTTOM LOCKING
8.	BOTTOM STRIKER
9.	STRIKER 13MM
10.	ANTI HANDLING MECHANISM
11.	ANTI HANDLING STRIKER
12.	CASEMENT HANDLE

TECHNICAL SPECIFICATIONS:

➤ Shutter Weight Capacity: 100 Kgs

➤ Sash Width: 400-1000mm

➤ Sash Height: 600-1800mm

➤ Colour Options: White & Ral 8022

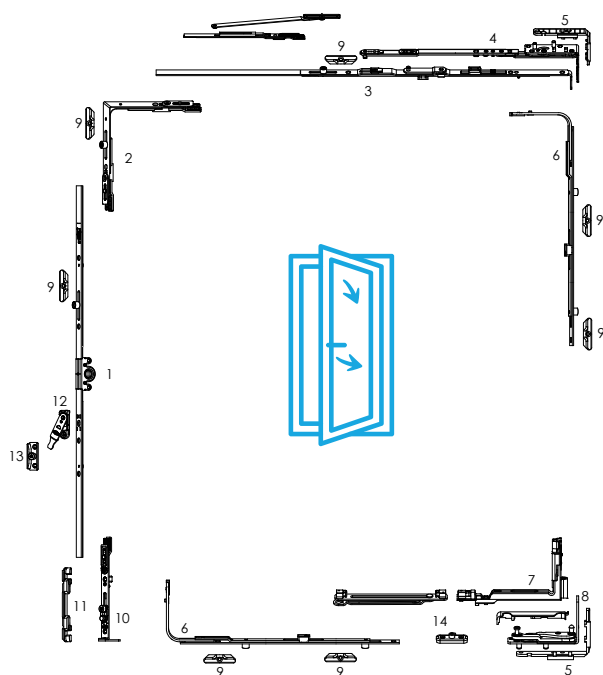

INVISIBLE TILT & TURN CONFIGURATION

S. NO.	DISCRIPTION
1.	INWARD OPENING ESPAGE
2.	CORNER TRANSMISSION
3.	STAY ARM
4.	TOP STAY HINGE
5.	HINGE CORNER PACKER
6.	MIDDLE LOCK
7.	BOTTOM CORNER HINGE
8.	BOTTOM PIVOT FRAME HINGE
9.	STRIKER 13MM
10.	BOTTOM LOCKING
11.	BOTTOM STRIKER
12.	ANTI HANDLING DEVICE
13.	ANTI HANDLING STRIKER
14.	CASEMENT HANDLE

TECHNICAL SPECIFICATIONS:

➤ Shutter Weight Capacity: 100 Kgs

➤ Sash Width: 400-1000mm

➤ Sash Height: 600-1800mm

➤ Colour Options: White & Ral 8022

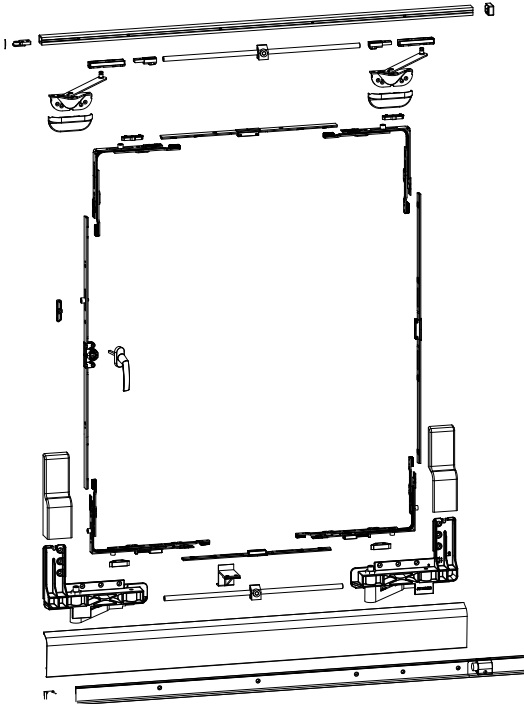

TILT & SLIDE HARDWARE

TECHNICAL SPECIFICATIONS:

- Type: Semi Automatic
-
- Axis: 13mm
-
- Sash Width: 885-1300mm
-
- Sash Height: 1985-2400mm
-
- Maximum Sash Weight: 130 kgs

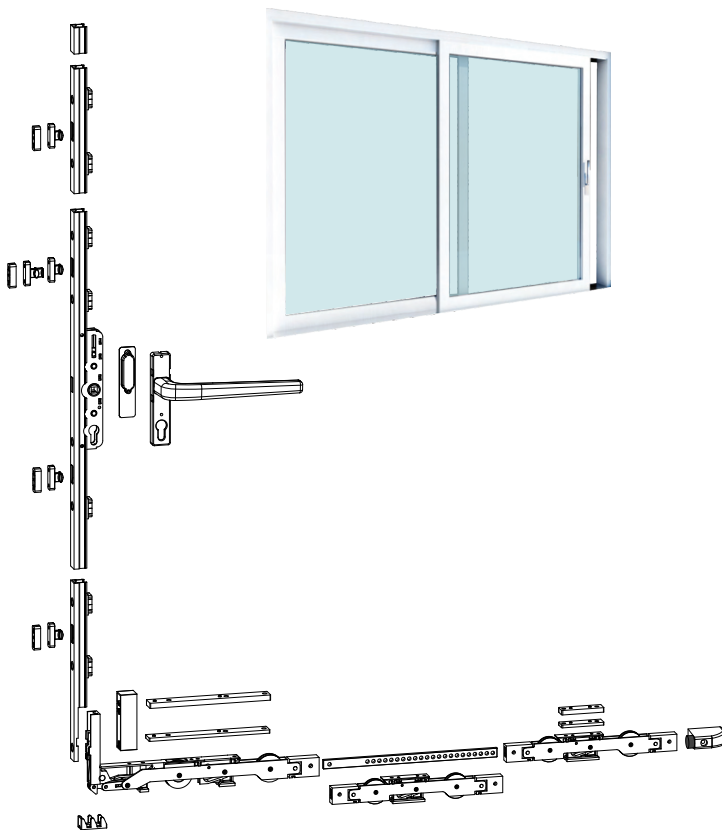

LIFT & SLIDE HARDWARE

TECHNICAL SPECIFICATIONS:

- Axis: 37.5mm / 32 mm
-
- Sash Width: 900-2200mm
-
- Sash Height: 2100-3200mm
-
- Maximum Sash Weight: 400/200 kgs

CASEMENT DOOR HANDLES



CASEMENT DOOR
HANDLE

HD 22T

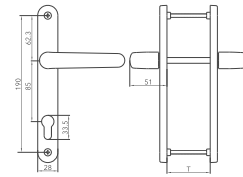

CASEMENT DOOR
HANDLE

HD 22P

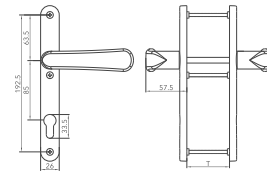

CASEMENT DOOR
HANDLE

HD 22-AS

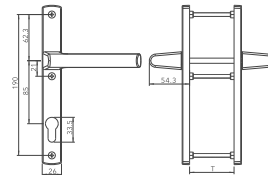

SHORT NECK
DOOR HANDLE

HD 22 SN

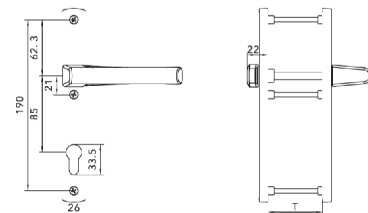

CASEMENT DOOR
HANDLE

HD 30

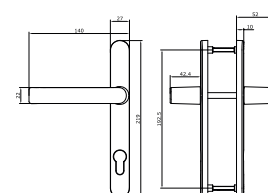

BATHROOM HANDLE
(ONE SIDE KNOB)

HD 24

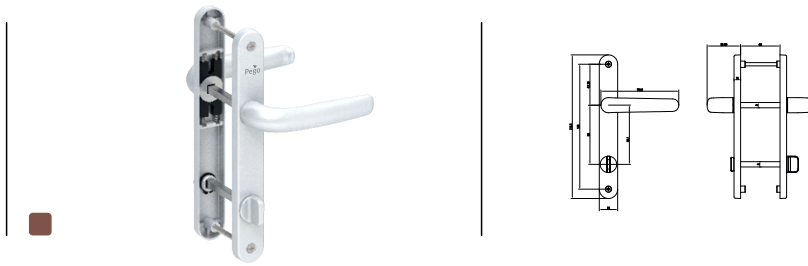

BOTH SIDE HANDLE
(ONE SIDE KEY)

HD 36



BOTH SIDE HANDLE
(ONE SIDE KEY
ONE SIDE KNOB)

HD 36B



BOTH SIDE HANDLE
(ONE SIDE KEY)
(FOR WINDOW SASH)

HD 41

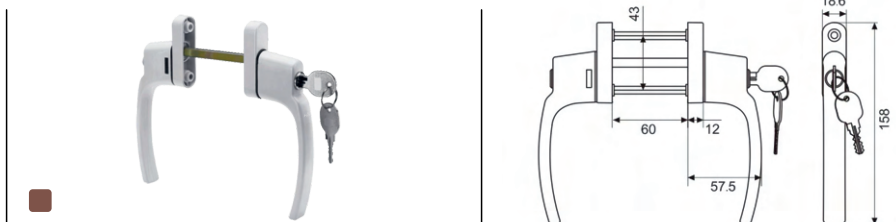

BOTH SIDE HANDLE
(ONE SIDE KEY
ONE SIDE KNOB)
(FOR WINDOW SASH)

HD 41B

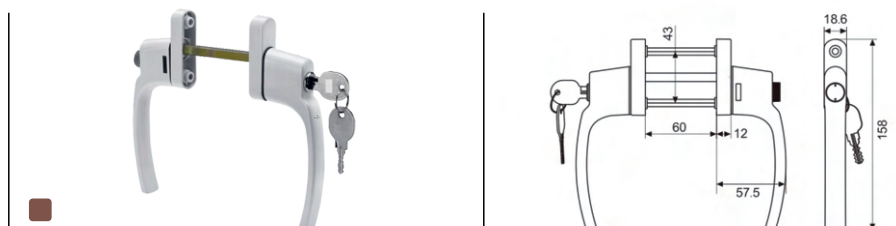

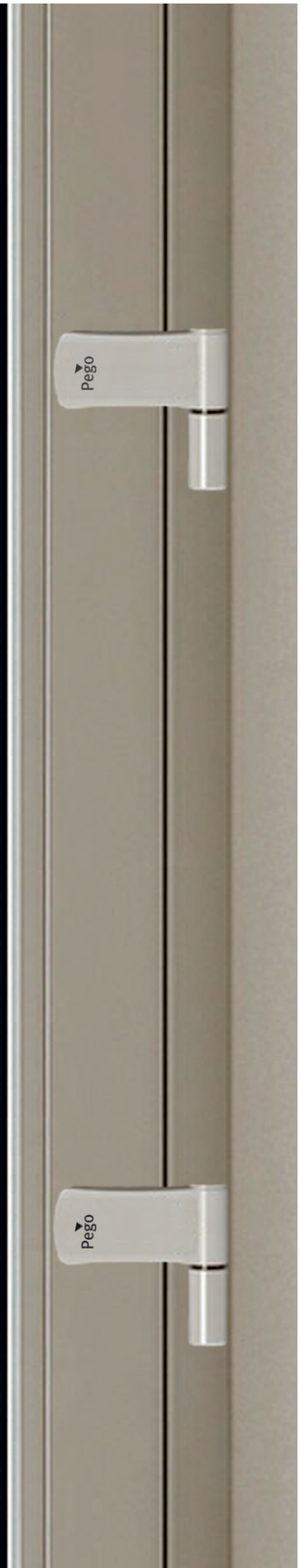

BUTT HINGE
100MM
BH 11-100

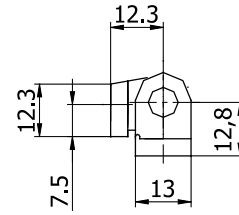

60kgs

FLAT HINGE
BH 13

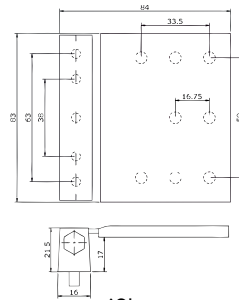

60kgs

L HINGE
BH 14

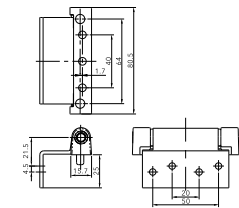

60kgs

WINDOW HINGE
(13MM AXIS)
BH 16

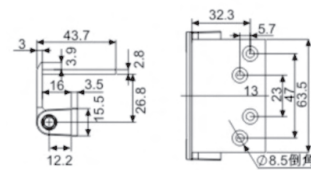

80kgs

CONCEALED
DOOR HINGE
BH 18

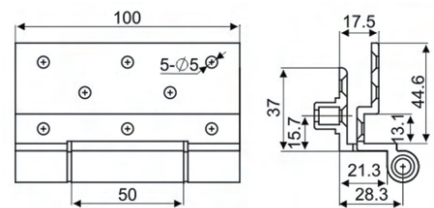
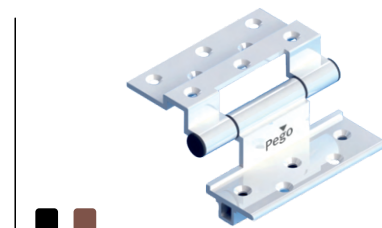

120kgs

CONCEALED WINDOW HINGE

BH 17

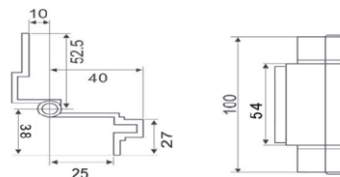

90kgs

CONCEALED WINDOW SASH HINGE

BH 19

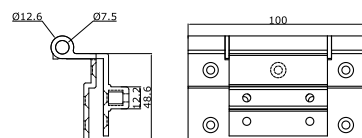
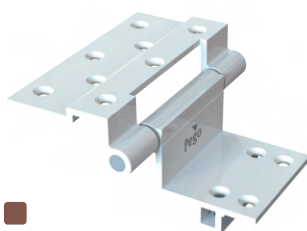

90kgs

MESH SHUTTER HINGE

BH 22

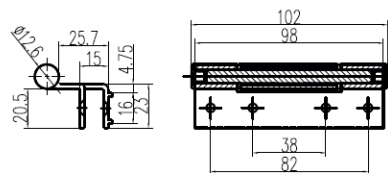

40kgs

WINDOW HINGE
(9mm AXIS)

BH 23

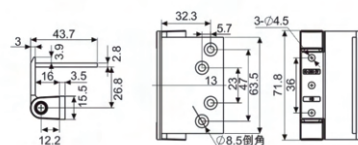

80kgs

CENTER SUPPORT HINGE
(9/13MM)

BH 21

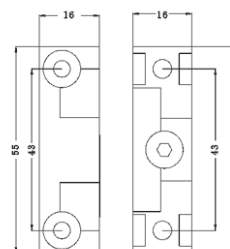
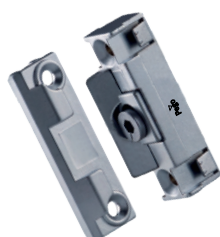

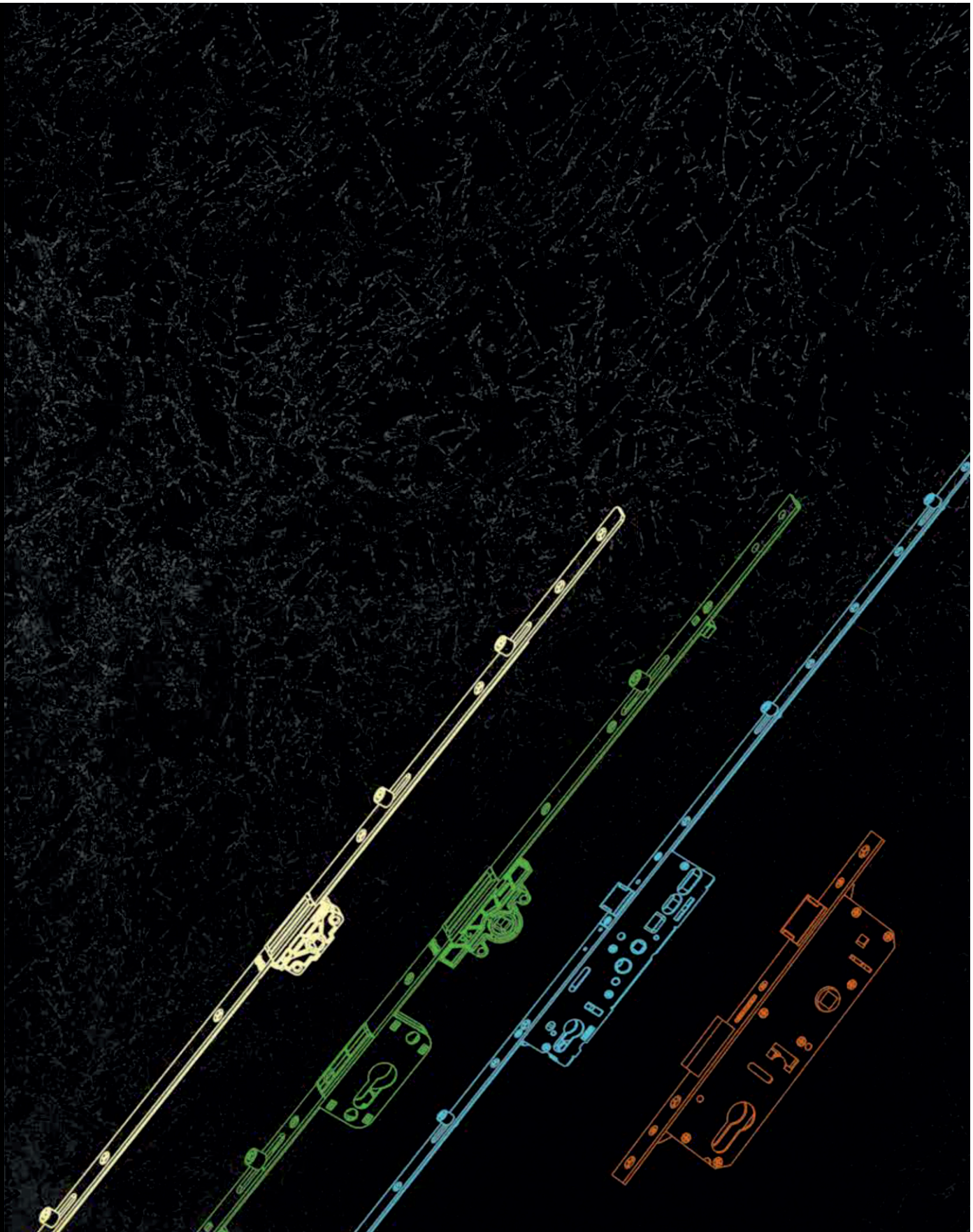

CASEMENT
WINDOW ESPAGE
(22MM BASCET)

CWG

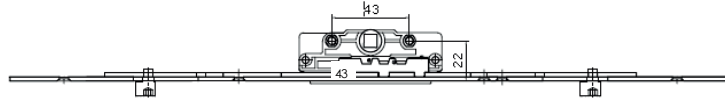

SLIDING
WINDOW ESPAGE
(7.5MM BASCET)

SWG

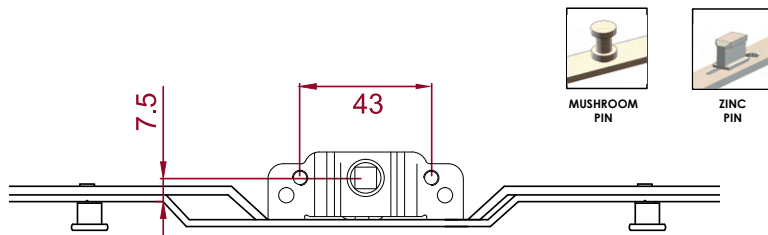

SLIDING
DOOR ESPAGE
(15MM BASCET)

SDG

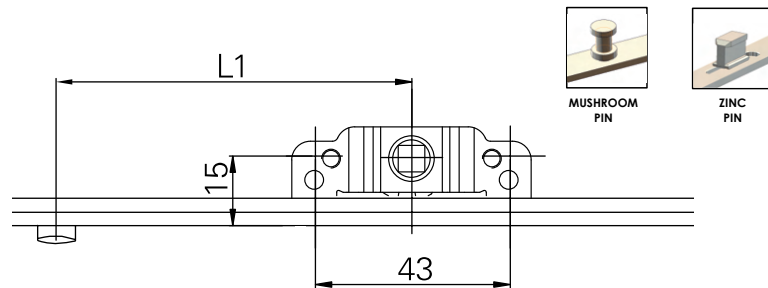

SINGLE PLATE
CASEMENT ESPAGE
(22MM BASCET)

SPG

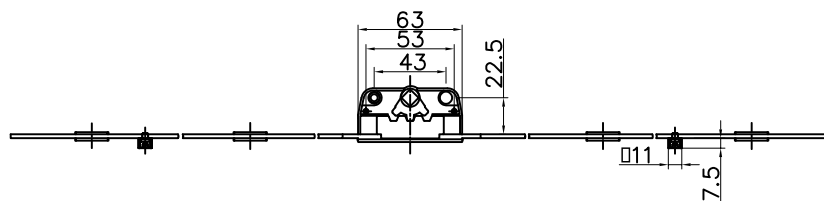

CASEMENT
DOOR ESPAGE
(30MM BASCET)

CDG-30

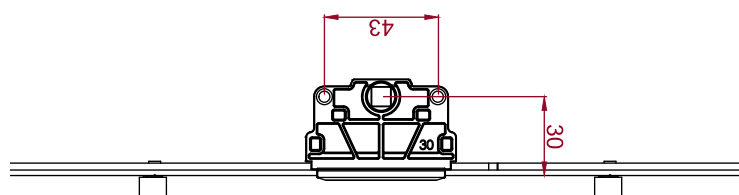

SLIDING LOCKABLE PATIO
DOOR ESPAGE

SDGPH

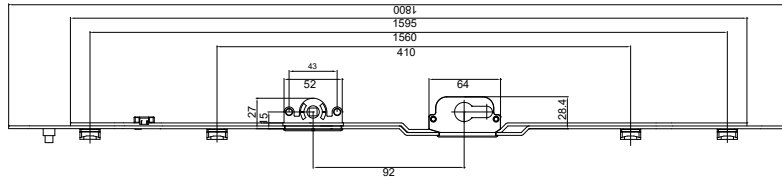

SLIDING LOCKABLE
DOOR ESPAGE

SDGS

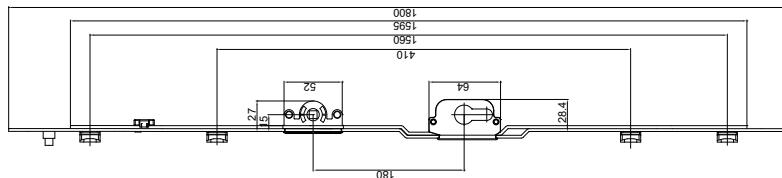

Length	7.5mm Backset	15mm Backset	22mm Backset	30mm Backset	Locking Point
400-1000	✓	X	✓	X	2
1200-1400	✓	✓	✓	X	3
1600-2200	✓	✓	✓	✓	4

Note: All espages available in SS 304 Grade also

CYLINDER WITH
ULTRA KEYS

CY



One Side Knob

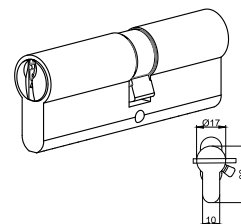

Product Code	Size	Both Side Key	One Side Knob	Half Cylinder
CY 60	60mm	✓	✓	✓
CY 70	70mm	✓	✓	✓
CY 80	80mm	✓	✓	✓
CY 85	85mm	✓	✓	✓
CY 90	90mm	✓	✓	✓

DOOR ESPAGE
WITH DEAD BOLT
(85*35mm)

CDG ++

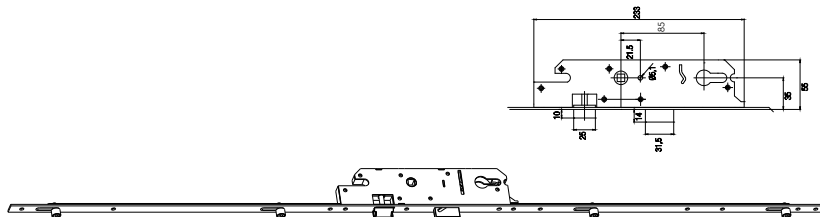

DOOR ESPAGE
WITH DEAD BOLT
(85*28mm)

CDG ++

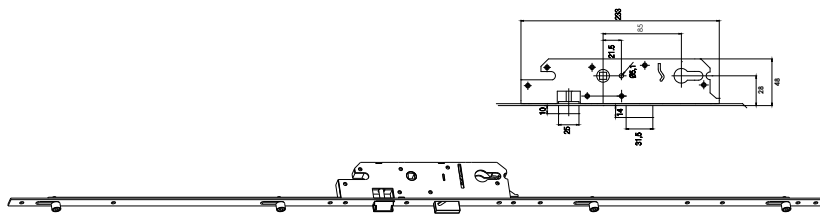

DOOR ESPAGE
WITH DEAD BOLT
(85*25mm)

CDG ++

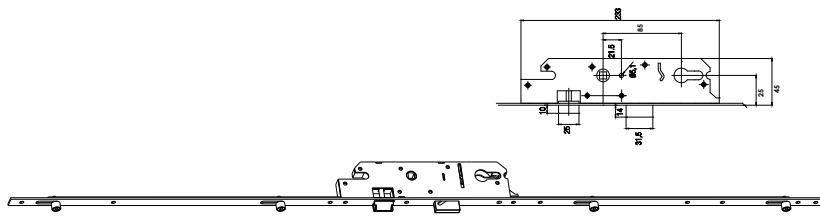

DOOR ESPAGE
WITHOUT DEAD BOLT
(85*35mm)

CDG + -

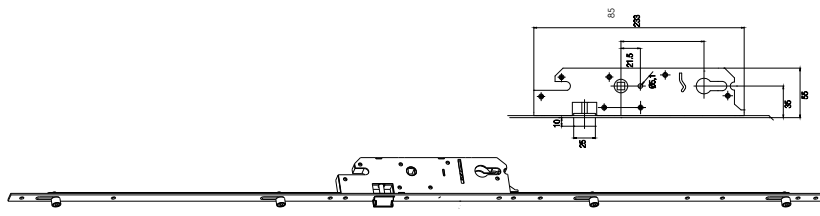

CUTTABLE WITH
CORNER TRANSMISSION
(2000-2200mm)
(85*35mm)

CDG-EXT

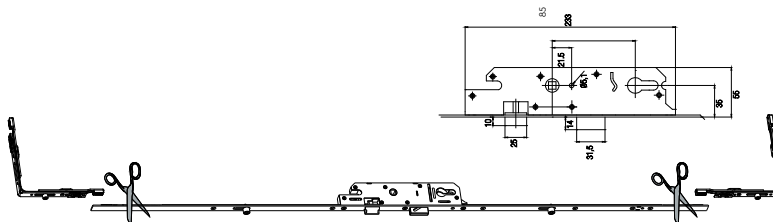

DOOR ESPAGE
WITH HOOKBOLT
LOCKING POINT
(85*35mm)

CDG-HKB

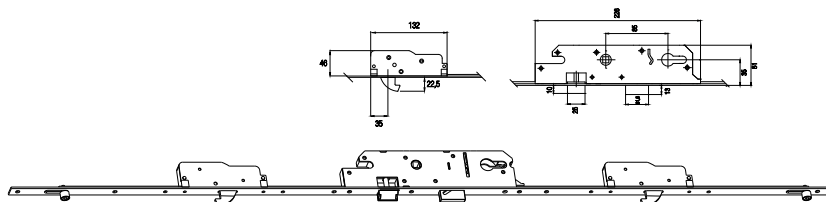

9MM AXIS
CASEMENT STRIKER

CWK 01

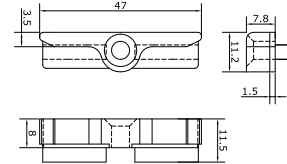

CASEMENT
REINFORCEMENT
STRIKER

CWK 02

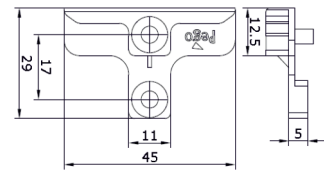

13MM AXIS
CASEMENT STRIKER

CWK 03

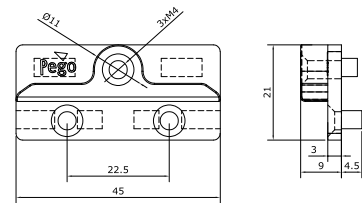

H TYPE
CASEMENT STRIKER

CWK 04

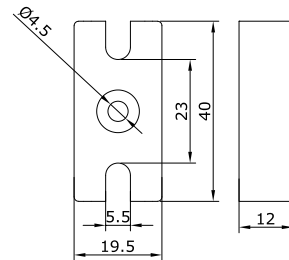
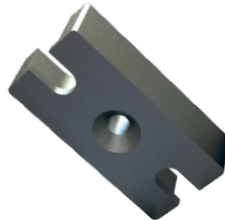

FRENCH DOOR &
WINDOW STRIKER

CWK 05

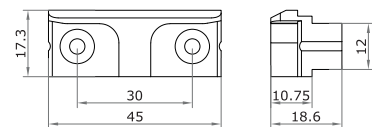
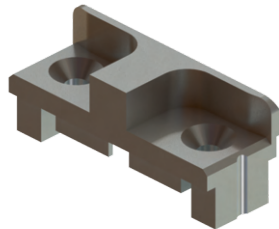

FRENCH DOOR &
WINDOW STRIKER

CWK 06

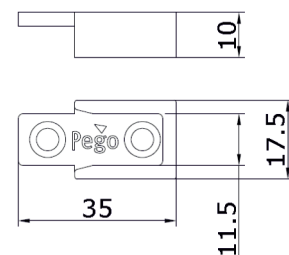

FRENCH DOOR
CASEMENT STRIKER

CWK 07

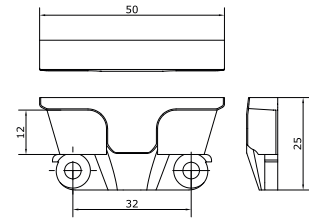

13MM AXIS
CASEMENT STRIKER

CWK 08

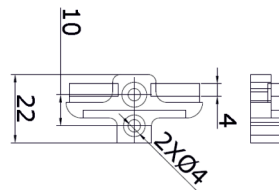

CASEMENT DOOR
STRIKER

CDK 01

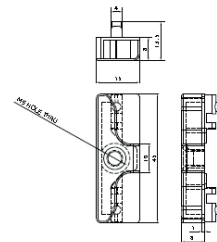

SLIDING STRIKER

SWK 02

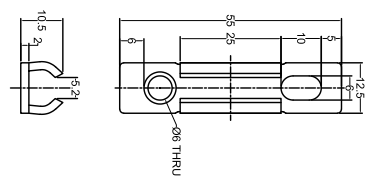

SLIDING
LG STRIKER

SWK 03

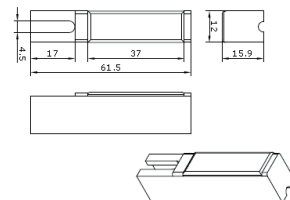

SLIDING ZINC
ANTILIFT STRIKER

SWK 04

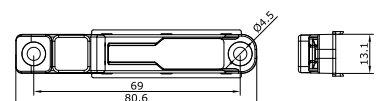
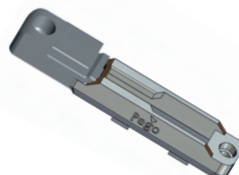

SLIDING STRIKER

SCP 11

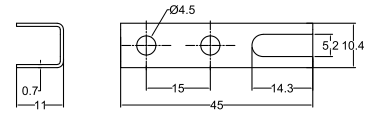
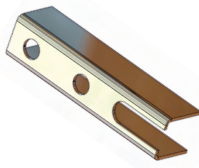

SHOOTBOLT WINDOW

TB 21

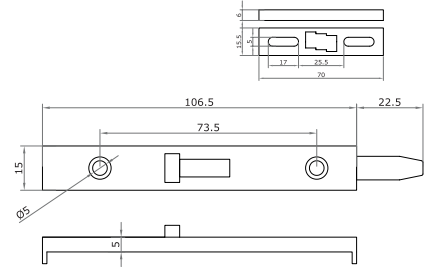
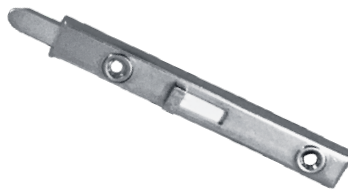

SHOOTBOLT DOOR

TB 22

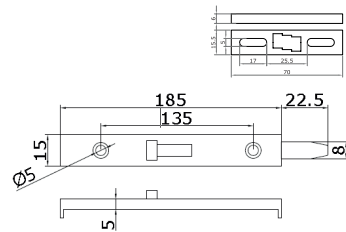

CENTRE OPERATED SHOOTBOLT (1800-2200mm)

TB 23

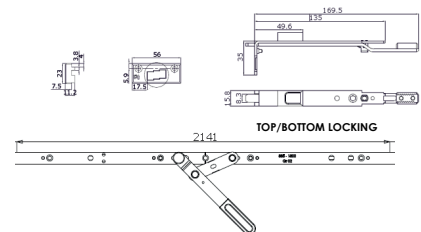

DOOR SHOOTBOLT SIZE: 10"

TB 24-10

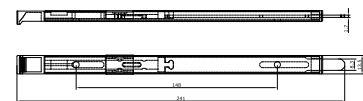

DOOR SHOOTBOLT SIZE: 16"

TB 24-16

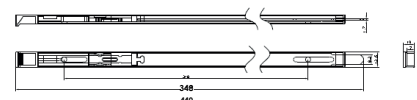

SHOOT BOLT
WINDOW

TB 26

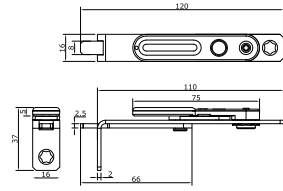

SHOOT BOLT
DOOR

TB 27

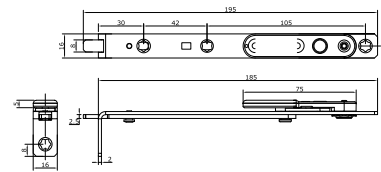

SHOOTBOLT STRIKER

CWK 09

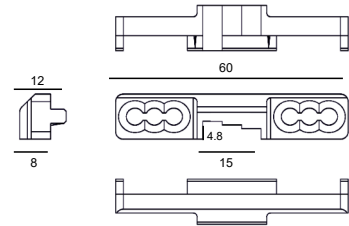

LOUVER

LVR



Blades	Lenght (mm)
3	290
4	280
5	470
6	560

SASH JAMMER

HD 45

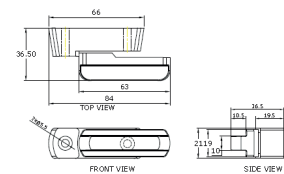

CENTRE DOOR
STRIKER

CP 11

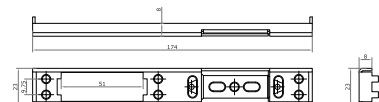

ROLLERS



SINGLE WHEEL GROOVE
NYLON ROLLER

SR 21PVC

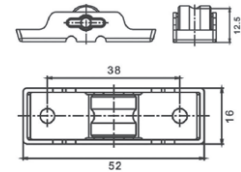
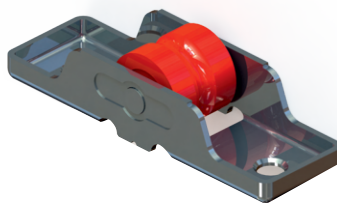

40 Kgs

SINGEL WEEL FLAT
NYLON ROLLER

SR 21PVCF

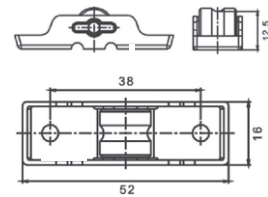
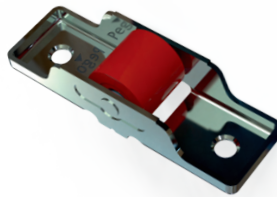

40 Kgs

SINGLE WHEEL GROOVE
NYLON ROLLER

SR 21PVC-14

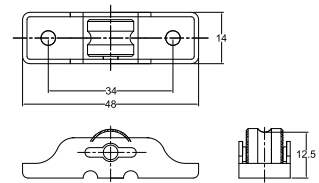
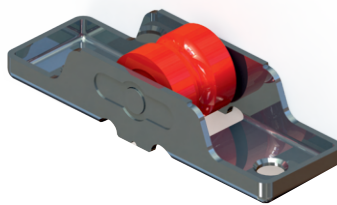

40 Kgs

SINGLE WHEEL
METAL ROLLER

SR 21M

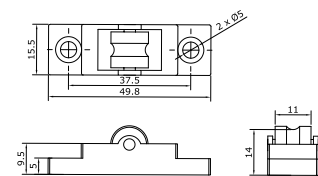
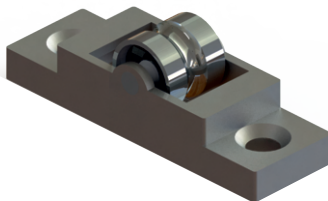

40 Kgs

DOUBLE WHEEL
NYLON SWING ROLLER

SR 23PVC

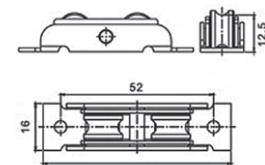
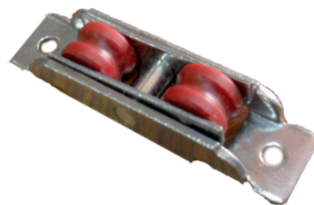

60 Kgs

MESH ROLLER

SR 27

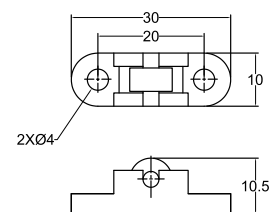
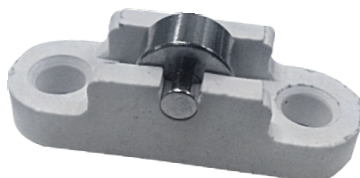

15 Kgs

NYLON
MESH ROLLER

SR 29

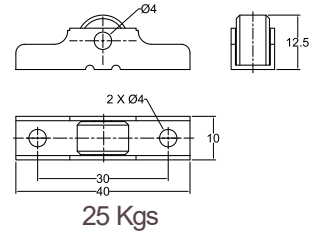
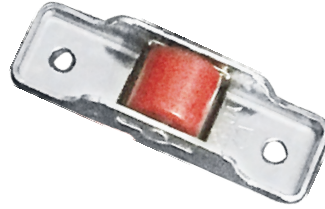

MESH ROLLER

SR 33

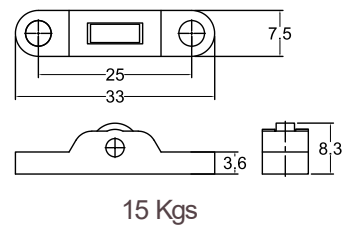

SINGLE WHEEL BALL
BEARING NYLON ROLLER
(NON EURO GROOVE)

SR 32

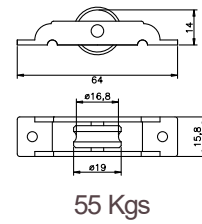
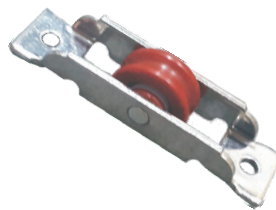

SINGLE WHEEL NYLON
SWING ROLLER

SR 63

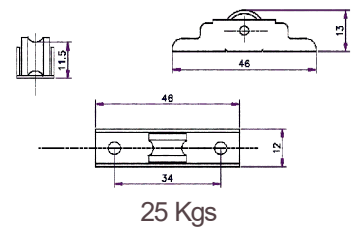

SINGLE WHEEL NYLON
SWING ROLLER

SR 64

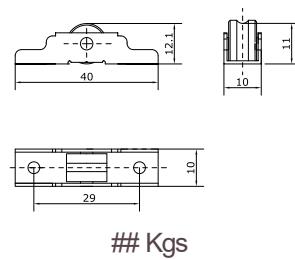

DOUBLE WHEEL METAL SWING ROLLER

SR 23M

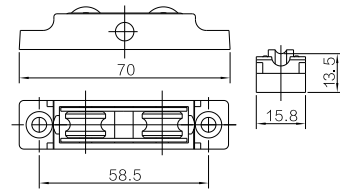

60 Kgs

SINGLE WHEEL BALL BEARING NYLON ROLLER (EURO GROOVE)

SR 25-12

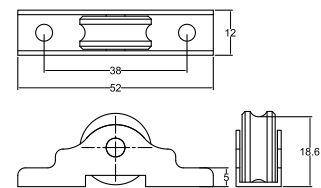

50 Kgs

DOUBLE WHEEL BALL BEARING NYLON ROLLER

SR 26-12

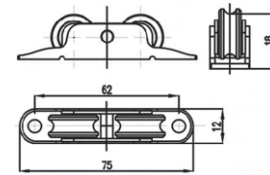

65 Kgs

DOUBLE WHEEL BALL BEARING ADJUSTABLE ROLLER

SR 28

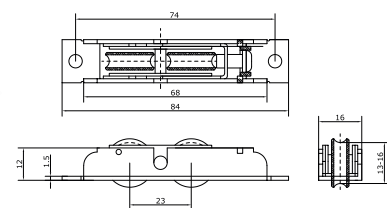

80 Kgs

ADJUSTABLE DOUBLE WHEEL NYLON DOOR ROLLER

SR 24

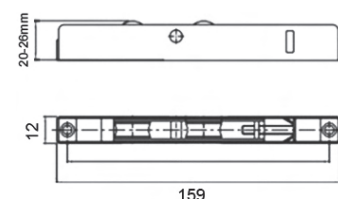

100 Kgs

ADJUSTABLE
DOUBLE WHEEL NYLON
DOOR ROLLER

SR 24-16

Note: Available in
SS 304 body as well

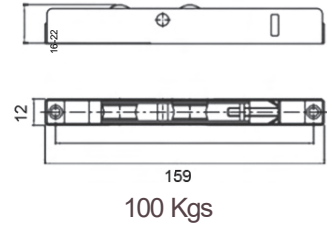

100 Kgs

ADJUSTABLE DOUBLE
WHEEL METAL
DOOR ROLLER

SR 24M

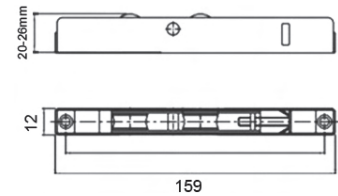

100 Kgs

ADJUSTABLE
DOUBLE WHEEL METAL
DOOR ROLLER

SR 24M-16

Note: Available in
SS 304 body as well

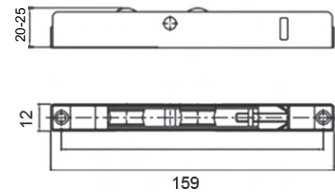
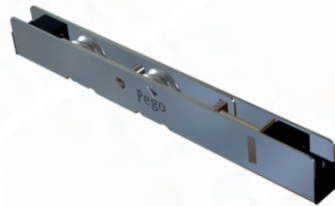

100 Kgs

SS BODY FOUR
WHEEL HEAVY DUTY
DOOR ROLLER

SR 30

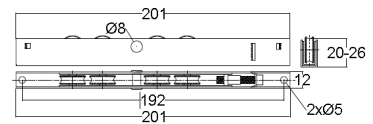

135 Kgs

SS BODY EIGHT
WHEEL HEAVY DUTY
DOOR ROLLER

SR 31

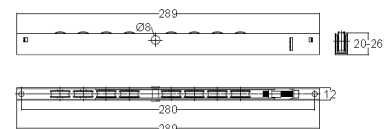

175 Kgs



SLIDING LONG
DOOR HANDLE

SL 45

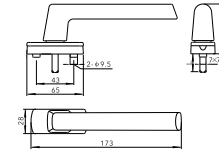

SLIDING DOOR
HANDLE

SL 54F

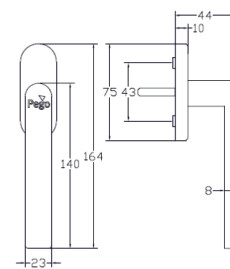

SLIDING LONG
DOOR HANDLE

SL 91

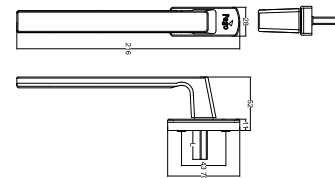

SLIDING DOOR
HANDLE

SL 92

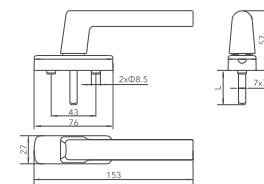

TRANSMISSION
HANDLE

SL 34M

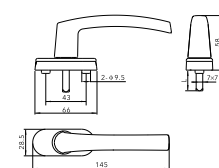

SHORT NECK
WINDOW HANDLE
(LEFT/RIGHT)

SL 37

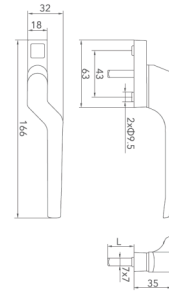

SHORT NECK
DOOR HANDLE

SL 38

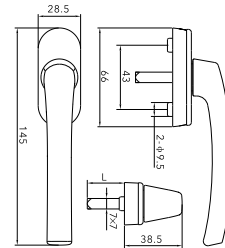

SHORT NECK DOOR
HANDLE (LEFT/RIGHT)

SL 47

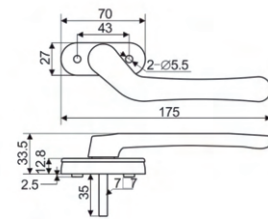

SHORT NECK
DOOR HANDLE

SL 50 N

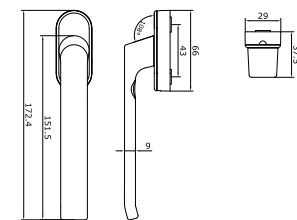

SHORT NECK
DOOR HANDLE

SL 55

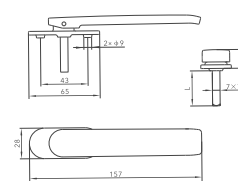

SHORT NECK
DOOR HANDLE
(LEFT/RIGHT)

SL 203

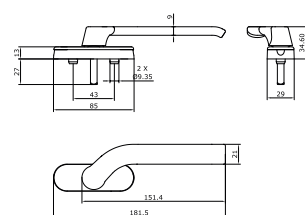

SLIDING POP UP HANDLES



POP UP HANDLE

SL 32-33

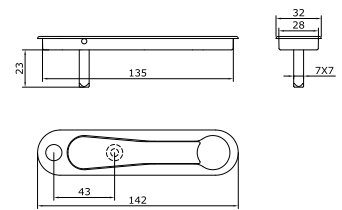

POP UP HANDLE

SL 32-25

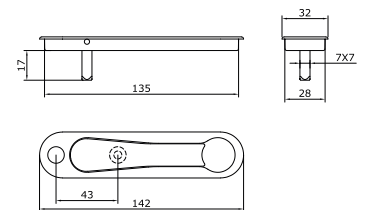

POP UP HANDLE

SL 48

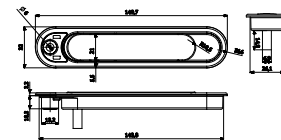

POP UP HANDLE
(BIG)

SL 43

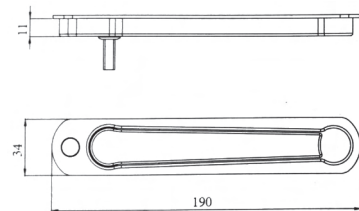

POP UP HANDLE
WITH KEY

SL 32K

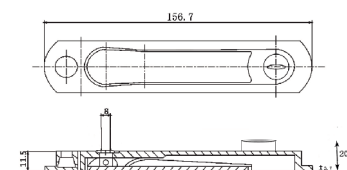

CRESCENT LOCK

SL 36

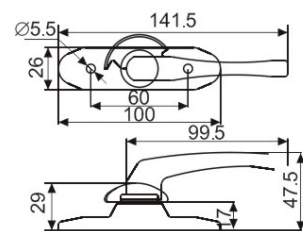

CRESCENT LOCK

SL 36S

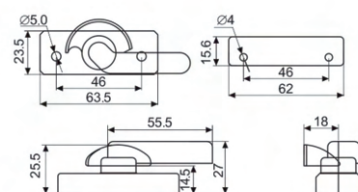

BUMP STOPPER

DS 11

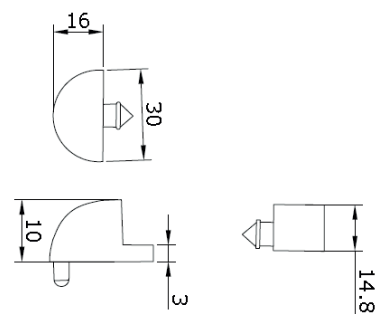

BUMP STOPPER

DS 12

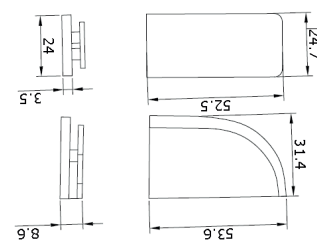

BUMP STOPPER

DS 13

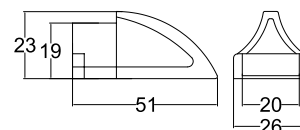

MESH HANDLE

SL 44

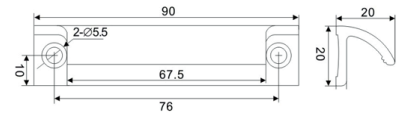

MESH HANDLE

SL 51

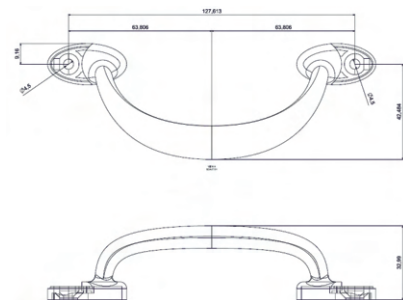

MESH LOCK

HD 46

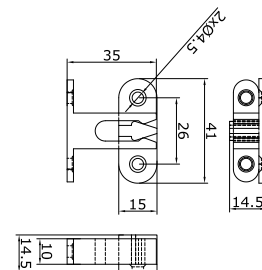
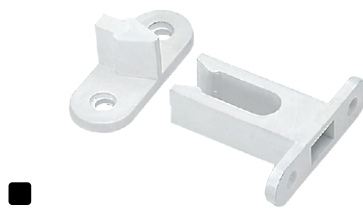

MECHANICAL JOINT

MJ 01

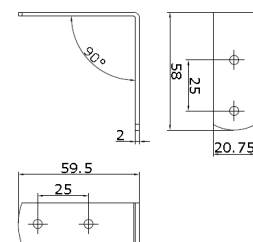

MECHANICAL JOINT

MJ 02

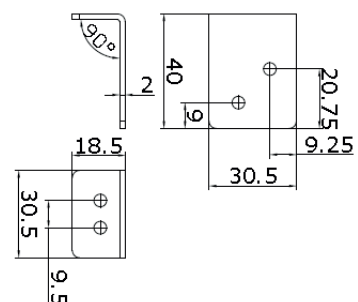

D HANDLE SERIES



SLIDING LOCKABLE
PATIO HANDLE ON
BOTH SIDES

SL 33

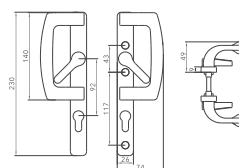

SLIDING NON-LOCKABLE
PATIO HANDLE
WITH DUMMY HANDLE

SL 33RD

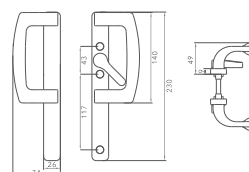

SLIDING LOCKABLE
PATIO HANDLE
WITH DUMMY HANDLE

SL 33D

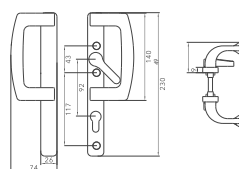

SLIDING NON-LOCKABLE
PATIO HANDLE
WITH RECESSED PLATE

SL 33R

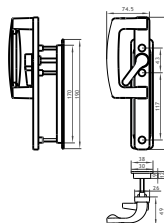

SLIDING LOCKABLE
PATIO HANDLE ON
BOTH SIDES

SL 33-2.5T

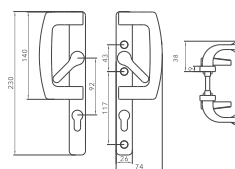

SLIDING NON-LOCKABLE
PATIO HANDLE
WITH DUMMY HANDLE

SL 33RD-2.5T

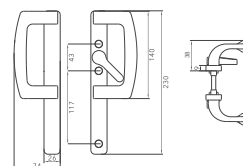

SLIDING LOCKABLE
PATIO HANDLE
WITH DUMMY HANDLE

SL 33D-2.5T

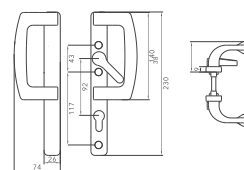

RECESSED DUMMY
HANDLE

SL 15

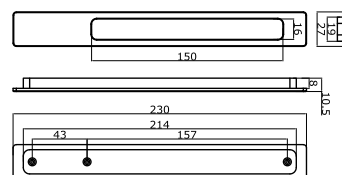

SLIDING UNIVERSAL
HANDLE WITH KNOB

SL 111

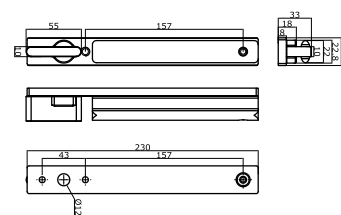

SLIDING UNIVERSAL
OUTSIDE HANDLE
WITH KNOB

SL 112

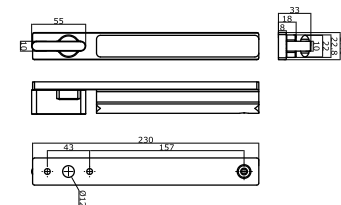

SLIDING UNIVERSAL
OUTSIDE DUMMY
HANDLE

SL 113

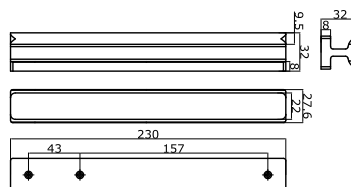

DUMMY FLUSH
HANDLE

SL 205

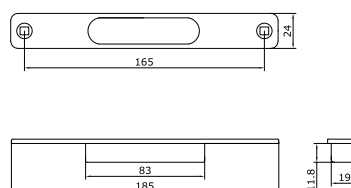



PREMIUM D HANDLE



SLIDING LEVER METRO HANDLE

SL 211

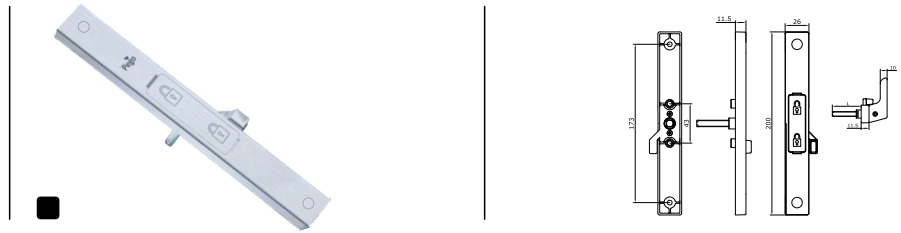

SLIDING D HANDLE
(FOR LEVER METRO HANDLE)

SL 212

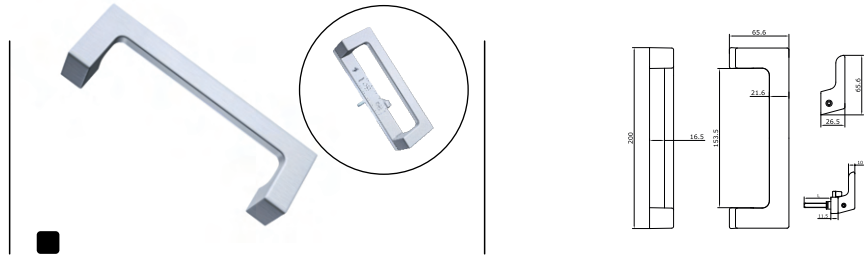

SLIDING DUMMY LEVER METRO HANDLE

SL 213

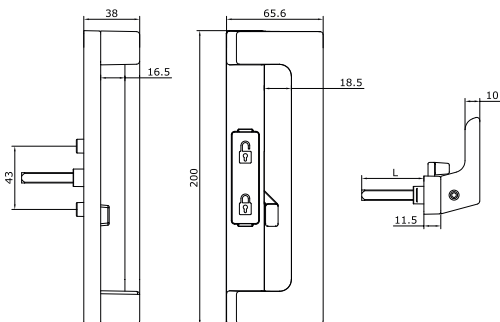
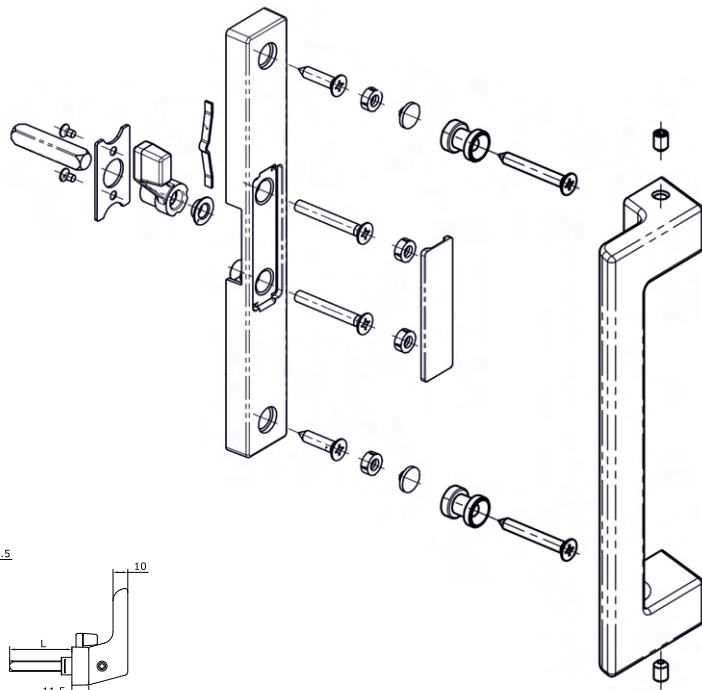
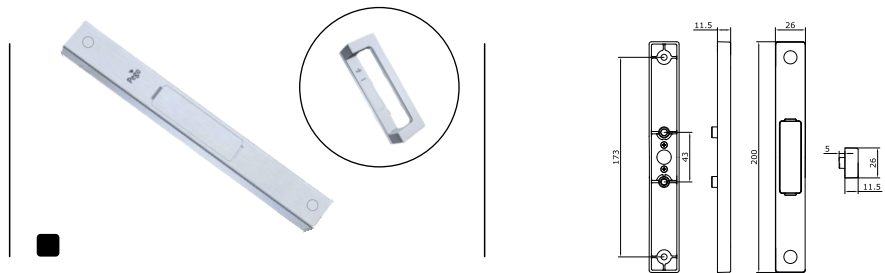

SLIDING D HANDLE COMPARATIVE MATRIX

 <p>SL 33</p>	 <p>SL 112 SL 111 CAP 36D</p>	 <p>SL 211+212+211+212 CAP 36D</p>
 <p>SL 33D</p>	 <p>SL 113 SL 111 CAP 36D</p>	 <p>SL 211+212+213+212 CAP 36D</p>
 <p>SL 33RD</p>	 <p>SL 113 SL 111</p>	 <p>SL 211+212+213+212</p>
 <p>SL 33R</p>	 <p>SL 15 SL 111</p>	 <p>SL 211+212+213</p>

SLIDING TOUCH LOCKS



SLIDING
TOUCH LOCK
(LEFT/RIGHT)

SL 31F

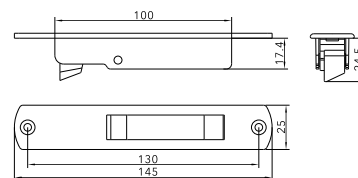

SLIDING
TOUCH LOCK
(LEFT/RIGHT)

SL 31A

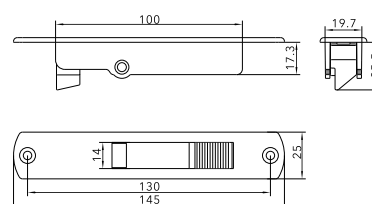

SLIDING
TOUCH LOCK
(LEFT/RIGHT)

SL 42

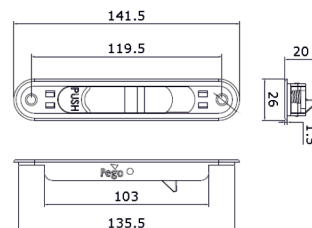

SLIDING
TOUCH LOCK
(LEFT/RIGHT)

SL 52

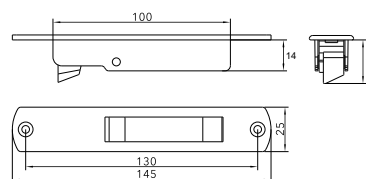



FRICION STAY

STAINLESS STEEL
FRICION STAY
(BAR THICKNESS: 2mm)

FS

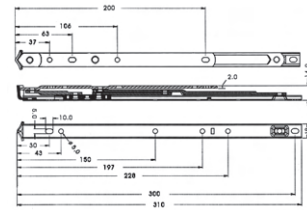

PRODUCT CODE	Hinge Size (in/mm)	Stack Height (mm)	Side Hung		Top Hung		Load Capacity (kgs)	Opening Angle (+/- 2.5°)
			Max Shutter Width (mm)	Max Shutter Height (mm)	Max Shutter Width (mm)	Max Shutter Height (mm)		
FS 08 A	08/205	13.5	450	900	900	450	8	87.5
FS 10 A	10/255	13.5	500	850	850	500	10	87.5
FS 12 A	12/310	13.5	550	1200	1200	550	12	87.5
FS 14 A	14/355	13.5	650	1200	1200	650	15	87.5
FS 16 A	16/405	13.5	650	1350	1350	650	17	87.5

STAINLESS STEEL
FRICION STAY
(BAR THICKNESS: 2.5MM)

FS -B

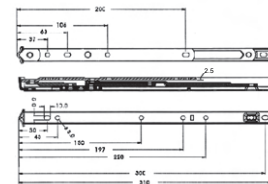

PRODUCT CODE	Hinge Size (in/mm)	Stack Height (mm)	Side Hung		Top Hung		Load Capacity (kgs)	Opening Angle (+/- 2.5°)
			Max Shutter Width (mm)	Max Shutter Height (mm)	Max Shutter Width (mm)	Max Shutter Height (mm)		
FS 10 B	10/255	16	500	1100	1100	500	12	87.5
FS 12 B	12/310	16	575	1200	1200	575	16	87.5
FS 14 B	14/355	16	650	1350	1350	650	19	87.5
FS 16 B	16/405	16	700	1500	1500	700	21	87.5
FS 18 B	18/455	16	750	1600	1600	750	23	87.5

STAINLESS STEEL
CONCEALED STAY
(9/13 mm AXIS)

CS 01



WEIGHT CAPACITY: 80 kgs

STAINLESS STEEL
FRICITION STAY
(HEAVY DUTY)

FS-C

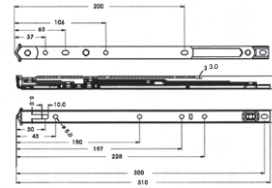

PRODUCT CODE	Hinge Size (in/mm)	Stack Height (mm)	Side Hung		Top Hung		Load Capacity (kgs)	Opening Angle (+/- 2.5°)
			Max Shutter Width (mm)	Max Shutter Height (mm)	Max Shutter Width (mm)	Max Shutter Height (mm)		
FS 10 C	10/255	16	600	1200	1200	600	22	87.5
FS 12 C	12/310	16	650	1300	1300	650	30	87.5
FS 14 C	14/355	16	700	1400	1400	700	34	87.5
FS 16 C	16/405	16	750	1500	1500	750	40	87.5
FS 20 C	20/505	16	NA	NA	1500	1500	80	30
FS 24 C	24/555	16	NA	NA	1500	1700	100	30

SINGLE X
PARALLEL STAY

PS-X

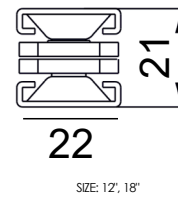

DOUBLE XX
PARALLEL STAY

PS-XX

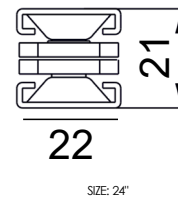

STAINLESS STEEL
RESTRICTOR ARM

RA

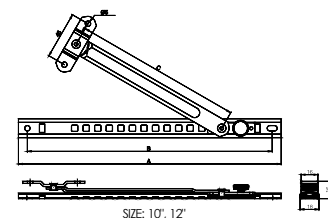

LIMITING ARM STAY

RA 102

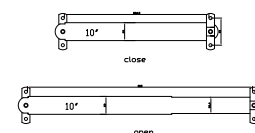

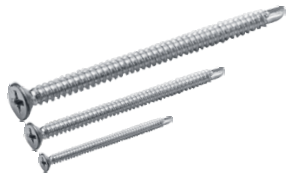

SD SCREWS



ANCHOR FASTENER

SIZE : 8*80, 8*100



WOOLPILE

SIZE : 5*6, 6*6, 6.8*6, 6*7



MESH ROLLON



U PACKER

SIZE : 2mm, 3mm, 5mm

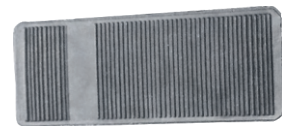

GLASS PACKER

SIZE : 2mm, 3mm, 5mm



FASTNER CAP



SLIDING STOPPER



SASH STOPPER



ANTILIFT

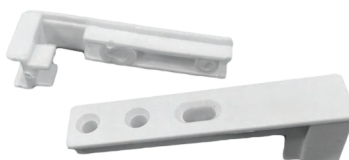

L ANTILIFT



DRAIN CAP

Experience Pego Hardware Sale Support



Head Office & Application Centre:

Pego Hardware

Plot No. 28/1/8, Site IV,
Sahibabad Industrial Area,
Ghaziabad (U.P.) - 201010 (India)

Regional Office (Delhi)

Pego Hardware

4899, Hauz Qazi,
Delhi - 110006 (India)

Regional Office (Coimbatore)

Pego Hardware

No. 2/227F Erangattu Thottam, Rasiptyam,
Sulur, Coimbatore - 641402 (India)

For Sales

North: +91-8929070621 | West: +91-8929070625 | Andhra & Telangana: +91-8929070624
East: +91-9319623434 | Karnataka: +91-9999697660 | Tamilnadu: +91-9717900843
W. Bengal & North-East : +91-9311600435 | UP, UK, J&K: +91-9871485577
Maharashtra: +91-9311600436

Customer Support: +91-9319444246 | E-Mail: info@pego.in | www.pego.in