

F R E E D O M[®]



PCK



Revision Knee Surgical Technique



Pursue Life[™]

CONTENTS

INTRODUCTION	1
Overview	1
Preoperative Planning.....	1
Incision and Exposure	2
Primary Implant Removal	2
STEMMED TIBIAL PREPARATION	3
STEP 1: Reaming IM Canal	3
STEP 2: Refining the Proximal Tibial Face Including Augmentation.....	4
STEP 3: Tibial Baseplate Positioning.....	6
STEP 4: Keel Preparation	9
PCK FEMORAL PREPARATION	10
STEP 1: Sizing the Femur	10
STEP 2: Reaming IM Canal	10
STEP 3: Distal Femoral Cut and Valgus Angle Preparation.....	11
STEP 4: Preparation for Anterior and Posterior Cuts	12
STEP 4A: A/P Cutting Block Positioning with No Femoral Offset	14
or	14
STEP 4B: A/P Cutting Block Positioning with Femoral Offset	15
STEP 5A: Set Up of Femoral Anterior/Posterior Cutting Block	16
STEP 5B: Performing Anterior and Posterior Cuts, Including Augment Cuts	16
STEP 6: Preparation for Intercondylar Box Cuts	17
STEP 6A: Positioning the PCK Box Cut Guide (BCG) with No Femoral Offset	18
or	18
STEP 6B: Positioning the PCK Box Cut Guide (BCG) with Femoral Offset	19
STEP 7: Performing Central Boss Reaming and Intercondylar Box Cuts	20
STEP 7A: Central Boss Reaming in Cases with No Femoral Offset	20
or	20
STEP 7B: Central Boss Reaming in Cases with Femoral Offset	21
STEP 7C: Intercondylar Box Cuts and Chamfer Cuts	21
TRIALING	22
Trialing the PCK Femoral Components	22
Trialing the Stemmed Tibial Components	24
Trialing the Patella	26
Trial Reduction and Gap Balancing	26
IMPLANTS	26
Preparing the Stemmed Tibial Implant Assembly	26
Preparing the PCK Femoral Implant Assembly.....	27
Implantation.....	28
a) Stemmed Tibial Components	28
b) PCK Femoral Components	29
c) Tibial Articulating Surface.....	29
d) Patellar Component	29



INTRODUCTION

The Freedom PCK® (Progressive Constraint Kinematics) Femoral and Stemmed Tibial Components are intended for use in revision knee replacement surgery. The stemmed tibial baseplate is designed to allow the addition of a stem extension with optional offset junction to the distal keel and optional augmentation blocks to the distal tray. Likewise, the PCK femur can accommodate a stem extension, as well as optional distal and posterior condylar augmentation blocks. The intercondylar box is tapered such that, throughout the range of motion, the joint transitions from natural laxity in flexion to high stability in extension.

Overview

Surgical technique is an important factor in providing consistent and reproducible results. Basic principles of total knee replacement surgery should be followed throughout the procedure. The surgeon must pay close attention to balancing the flexion and extension gaps, accurately sizing the femoral, tibial, and patellar components, positioning the femoral component in appropriate external rotation, removing excessive osteophytes from the posterior condyles, maintaining the joint line, and implanting the final components using modern cementing techniques.

Preparation of the femur, tibia, and patella is independent for each bone and can be performed in any order, based on surgeon preference. The principles of measured resection (replacing removed bone with equal amounts of implant) are used to provide this versatility during the operation. When trialing the implants, it is recommended that the surgeon assess overall alignment, extension angle, varus/valgus stability, flexion angle, patellofemoral tracking, and anterior/posterior stability. The surgical technique outlined is specific to the Freedom Knee® System.

Preoperative Planning

Preoperative radiographs can be used to anticipate aspects of the surgical procedure including implant sizing, stem extension length and diameter, quality of bone stock, and alignment of bone cuts. X-rays should include coronal and sagittal views of the operative knee in full extension. You may contact your Maxx representative for x-ray templates. Templates are available for all digital platforms.

The angle between the mechanical and anatomic axes of the femur should be reproduced intraoperatively. The tibial component should be positioned perpendicular to the mechanical axis of the tibia in the frontal plane. Implant sizing must be determined intraoperatively as x-rays only provide an approximation.

Incision and Exposure

The technique described uses the classical anterior midline incision to access the knee joint via a medial parapatellar arthrotomy. However, the subvastus and midvastus approaches can readily be used with the same instrumentation. When possible, follow the pre-existing scar from the primary procedure. Your Maxx representative can supply instrumentation to accommodate your preferred approach.

Primary Implant Removal

Preserve as much bone stock as possible when removing the primary implants. It is generally beneficial to remove the femoral implant first, as this can improve access to the tibial components.

A variety of tools can be utilized to disrupt the implant-bone interface, including osteotome, reciprocating saw, Gigli saw, and dedicated extraction instruments. Your Maxx representative can provide a **femoral impactor/extractor** and **slap hammer** to aid in femoral implant removal.

Remove any bone cement that remains after primary implant extraction. Use **tibial alignment guide blocks** to measure the flexion and extension gaps, as a predictor for implant sizing and tissue balancing requirements.

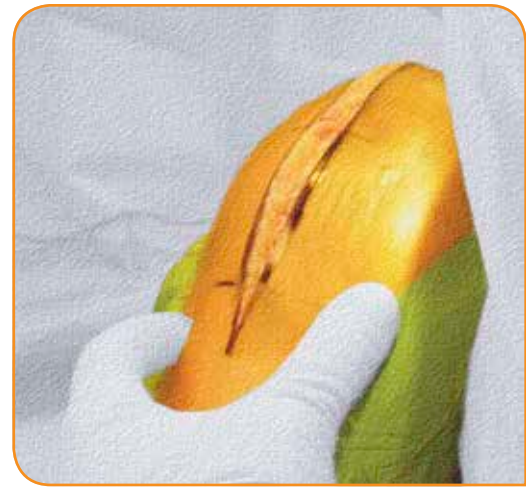

Incision

STEMMED TIBIAL PREPARATION

STEP 1: Reaming IM Canal

Remove cortical bone to accommodate the stem extension and optional offset junction.

Consult Table A to determine the reamer depth marking corresponding to the stem extension and optional offset junction combination to be implanted. Ream the medullary canal with a sharp-tipped **distal reamer** (6.5mm or 9mm) until the appropriate depth marking reaches the surface of the proximal tibia (Fig. T1). Progressively increase reamer diameter in 0.5mm increments until the desired cortical bone contact is achieved. The ultimate reamer and stem diameters should match when uncemented; ream an additional 0.5mm or 1mm, in diameter, if cementing.

NOTE

The reamed depth of the IM canal increases if the tibial component is to be offset, see Table A at right. If the need to offset the tibia is undetermined at this time, the additional depth can be reamed later.

Subsequent instrumentation uses the $\varnothing 9\text{mm}$ shaft of the **distal reamer** as a positioning reference. However, in the case of a narrower $\varnothing 7.5\text{mm}$ stem, the **IM 9mm tibial alignment rod** can be used instead of the reamer. This rod provides more length at the required $\varnothing 9\text{mm}$ to attach instrumentation. It can also be used for a $\varnothing 9\text{mm}$ stem, if preferred.

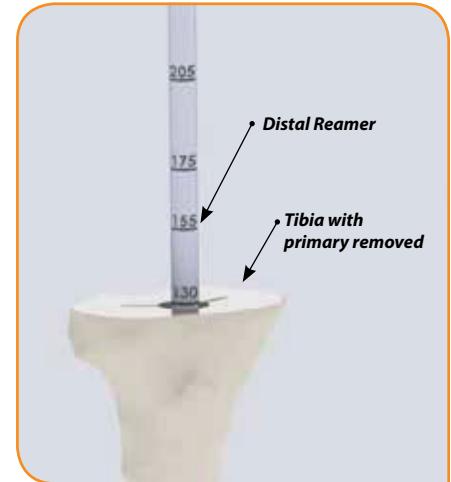

Figure T1: Reaming IM Canal

TABLE A
TIBIAL IM CANAL REAMING DEPTH REQUIREMENTS

STEM LENGTH	REAMER DEPTH MARKING	
	No Offset	With Offset
40mm	65	100
75mm	100	130
100mm	130	155
150mm	175	205

STEP 2: Refining the Proximal Tibial Face Including Augmentation

Refine the proximal tibial face after primary implant removal in order to improve the bone's interface with instruments and implant. The depth of resection should be minimized to preserve bone stock.

Assemble the **IM tibial cutting guide (TCG)** (Fig. T2) by inserting the **reamer connector** through the slot in the vertical body and connecting the appropriate left, right or universal **TCG jig** onto the **jig connector**. Secure the **TCG jig** by rotating the **jig lever** to expose the lock symbol. Slide the **reamer connector** over the **distal reamer** and tighten the **reamer knob** to secure the entire guide to the **distal reamer** at roughly the desired height. Slide the **jig connector** and **TCG jig** along the vertical body and engage the **cam lever** to lock them in place. An **angel wing** through the cutting slot can help visualize the amount of resection as well as any need for medial and/or lateral augmentation. Fine tune the resection level by turning the knurled **thumb knob** clockwise to resect less bone and counter-clockwise to resect more bone. Snug the **TCG jig** against the anterior of the tibia using the ratcheting connection between the **vertical body** and **reamer connector**. It can be released and repositioned by depressing the button in the **vertical body**.

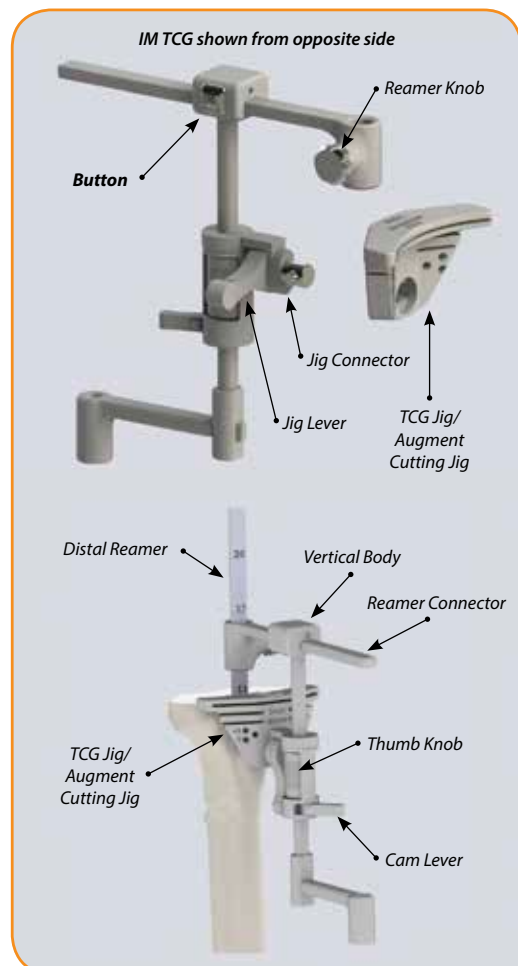

Figure T2: Assembling Tibial Cutting Guide

NOTE

The left and right **TCG jigs** (shown in Figure T3) have a single cutting slot and '0' pinning holes as well as '+2' and '-2' hole options. The universal **TCG jig** (shown in Figure T2) has a '0' cutting slot and additional augment cutting slots and therefore should be used when augmentation is anticipated. The universal jig also has '0' and '+5' pinning hole options.



Figure T3: Tibial Cutting Guides

With the desired resection level set, pin the **TCG jig** to the tibia using **straight pins** through the '0' pinning holes. Remove the **tibial cutting guide (TCG)** by releasing the **jig lever**, depressing the button on the side of the **vertical body**, and separating the guide from the pinned **TCG jig**. Loosen the knob on the **reamer connector** and remove it from the **reamer**. The **distal reamer** and the pinned **TCG jig** should be the only instrumentation remaining at this point.

Proceed to resect the tibia using an **oscillating saw** through the cutting slots in the **TCG jig**, removing the **distal reamer**, if necessary (Fig. T4). In either the left, right or universal **TCG jig**, use the top captured cutting slot to make a '0' or clean up cut of the proximal tibia surface. Assess the need for medial and/or lateral augmentation with the aid of an **angel wing**. With the universal (augment) **TCG jig**, use the '5mm' or '10mm' cutting slots to resect the tibia for either one or two augments. For three augments or 15mm of resection, reposition the universal **TCG jig** on the '+5" holes and cut through the '10mm' cutting slot. Additional pins can be used through the angled holes for further fixation with any of the available **TCG jigs**.

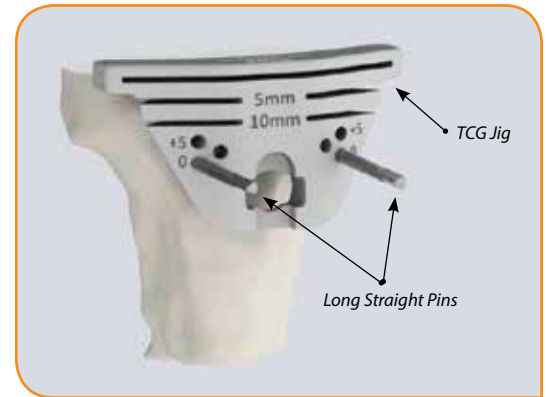

Figure T4: Pinning Tibial Cutting Jig

NOTE

Cuts through the slots in the **TCG jigs** result in a 3° posterior slope of the resected tibia.

NOTE

Tibial augments are optional for use with the **stemmed tibial baseplate**. They are 5mm thick and may be stacked up to three high to correct defects from 5mm to 15mm. **Tibial augments** are reversible to address both medial and lateral defects and decreasing sizes can be stacked accordingly to create a conical profile. Differing amounts of augmentation between the medial and lateral sides can also be accommodated.

STEP 3: Tibial Baseplate Positioning

Size and position the tibial baseplate to achieve maximal coverage of the proximal tibial surface, either centered about the IM canal or offset by 4mm or 6mm.

If removed for resection, reintroduce the **distal reamer** into the IM canal. Select the appropriately sized **tibial offset guide plate**, which has bony support on all sides with no overhang. If tibial augment cuts were made in the previous step, select the corresponding size and thickness of **tibial offset guide plate augments** (referred to as “augments” here) to attach to the underside of the **tibial offset guide plate**. Attach the **augments** with the appropriate length **augment pin** (Fig. T5a) If desired, hold the **tibial offset guide plate** with the **tibial tray coupler** (Fig. T5b).

For appropriate positioning, start by placing the **tibial offset guide plate** over the **distal reamer** and against the resected proximal tibia. Next, slide the **central dial** over the **distal reamer** and secure it in the recess of the **tibial offset guide plate** (Fig. T6). Keep the underside of the **tibial offset guide plate** against the resected proximal tibia and slightly rotate it about the **distal reamer** to achieve maximum coverage. If coverage is optimal, secure the **tibial offset guide plate** to the tibia with **long pins**. In this case, the **tibial offset guide plate** is centered about the IM canal and therefore no tibial offset will be performed.

NOTE

For cases with NO tibial offset, proceed directly to Step 5 on Keel Preparation.

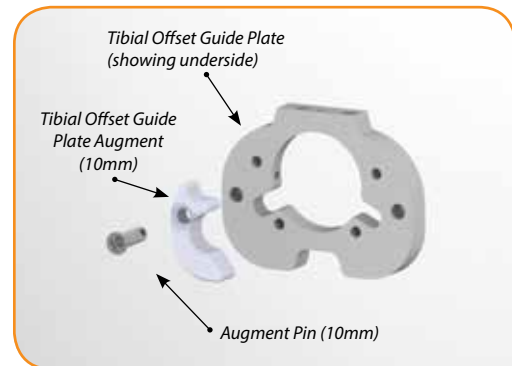

Figure T5a: Assembling Tibial Guide Plate and Augments

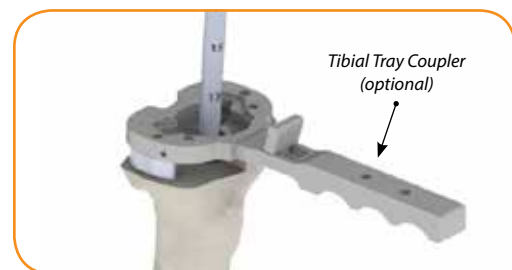

Figure T5b: Positioning Tibial Guide Plate

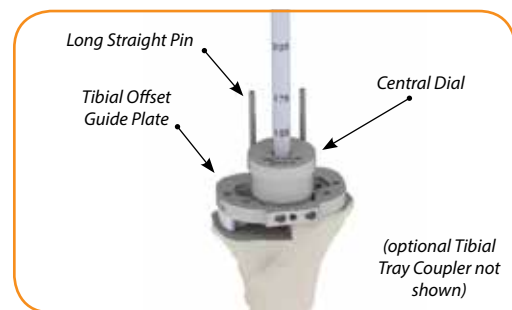

Figure T6: Pinning Tibial Guide Plate (NO offset)

However, if tibial coverage is inadequate with the **tibial offset guide plate** positioned using the **central dial**, as shown in Figure T7a, better coverage will be achieved through offsetting the **tibial component** with respect to the IM canal.

In these cases, an **offset junction component** will later be included between the **tibial baseplate** and the **tibial stem**. At this time and taking advantage of the current instrument setup, the tibia will be prepared to accommodate the distal portion of this **offset junction component** that is in line with the IM canal (Fig T7a). Having positioned the **tibial offset guide plate** using the **central dial**, secure the **tibial offset guide plate** to the tibia with **long pins**. [Note that the coverage of the **tibial offset guide plate** on the resected tibial plateau is not ideal in this position and its final position will be determined later using an **offset dial**.] Remove the **central dial** and **distal reamer** and place the **tibial broach housing** in the recess of the pinned **tibial offset guide plate**. Using the **entry reamer**, gently ream until the proximal most end of the **reamer** reaches the top of the **tibial broach housing** (Fig. T7b).

NOTE

Alternatively, the **ø17mm distal reamer** can be used in place of the **entry reamer**. Ream until the 100mm groove reaches the top of the **tibial broach housing**.

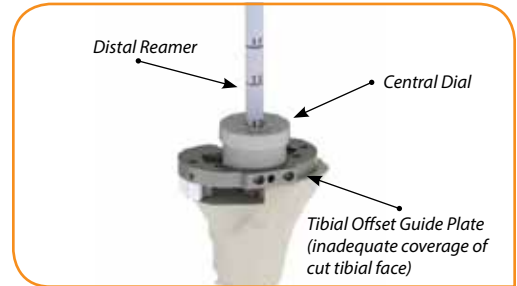

Figure T7a: Temporary positioning of Tibial Guide Plate (Offset to be performed)

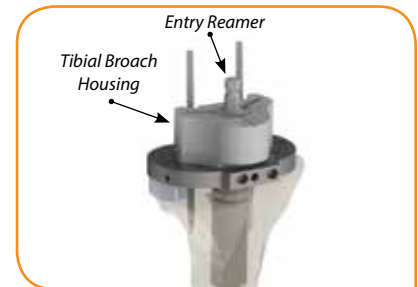

Figure T7b: Reaming for distal portion of Offset Junction

With the distal portion of the bone prepared for the offset junction, the **tibial offset guide plate** will now be repositioned, representing the final location of the **tibial baseplate**. Two **offset dials** of 4mm and 6mm are available. These **offset dials** offer a ball plunger/detent tactical interface with the **tibial offset guide plate** and provide 360 degrees of relative offset positioning of the **tibial baseplate** with respect to the IM canal. Reintroduce the **distal reamer** into the IM canal, and if needed, ream the additional depth noted for the Stem with Offset Junction in Table A, at right. (Be sure to reduce this reaming depth accordingly for any augment cuts already performed on the proximal tibial face).

Drop the **tibial offset guide plate** over the **reamer** onto the surface of the tibia. Slide the **4mm offset dial** over the **distal reamer** and secure it in the recess of the **tibial offset guide plate** (Fig. T8). Turn the **4mm offset dial** about the **distal reamer**, repositioning the **tibial offset guide plate** on the surface of the resected tibia to achieve optimal coverage. If coverage is still inadequate, repeat this process using the **6mm offset dial**. Determine the best-fit combination of baseplate size, offset amount, and offset positioning, and then secure the **tibial offset guide plate** to the tibia with **long pins**. In using an **offset dial**, it is important to note which marking on the **offset dial** is aligned with the midline marking on the **tibial offset guide plate** (Fig. T8). Remove all instrumentation except the pinned **tibial offset guide plate** and proceed to the next step, Keel Preparation.

TABLE A
TIBIAL IM CANAL REAMING DEPTH REQUIREMENTS

STEM LENGTH	REAMER DEPTH MARKING	
	No Offset	With Offset
40mm	65	100
75mm	100	130
100mm	130	155
150mm	175	205

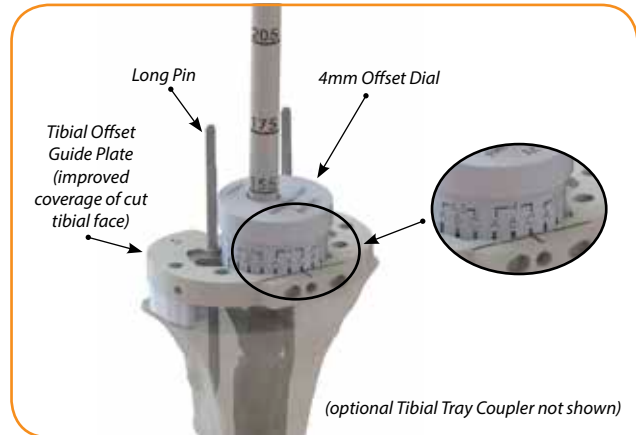

Figure T8: Final positioning of Tibial Guide Plate (Offset to be performed)

NOTE

Recording the offset dial marking that aligns with the midline marking on the offset guide plate (in this case, '4C') aids in later assembling the trial and implant components correctly.

STEP 4: Keel Preparation

Ream to remove cancellous bone to accommodate the tibial keel and the proximal portion of the optional offset junction. Broach to accommodate the tibial keel.

Ream for the tibial keel and optional offset junction:

Place the **tibial broach housing** in the recess of the pinned **tibial offset guide plate**. For no offsetting, use the **entry reamer** to gently ream the proximal tibia until the *distal* most groove on the **reamer** reaches the top of the **tibial broach housing** (Fig. T9a). In cases of offsetting, use the **entry reamer** to gently ream the proximal tibia until the *proximal* most groove on the reamer reaches the top of the **tibial broach housing** (Fig. T9b). The additional reamed depth will prepare the bone to accept the proximal portion of the **offset junction component**.

NOTE

Alternatively, the **ø17mm distal reamer** can be used in place of the **entry reamer**. For no offsetting, ream until the 65mm groove reaches the top of the **tibial broach housing**. Ream an additional 5mm if the tibial component is being offset.

Broach for the tibial keel:

Insert the **tibial broach** through the **tibial broach housing** and gently tap until it reaches its endpoint (Fig. T10, shown here with no offset). Extract the broach from the bone, using a slap hammer if necessary.

The tibia is now prepared for trialing. Figure T11 depicts the tibia prepared for cases in which an **offset junction** will be implanted, showing accommodation for both the proximal and distal portions of the **offset junction** as well as the tibial keel.

Remove all instrumentation for trialing.

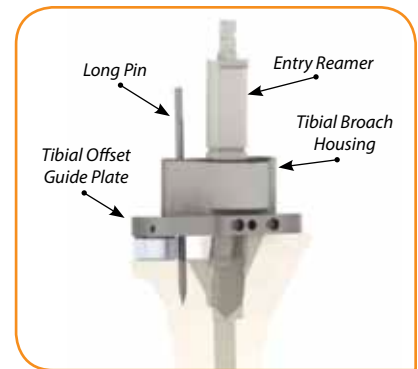

Figure T9a: Tibial Keel Reaming (NO offset)

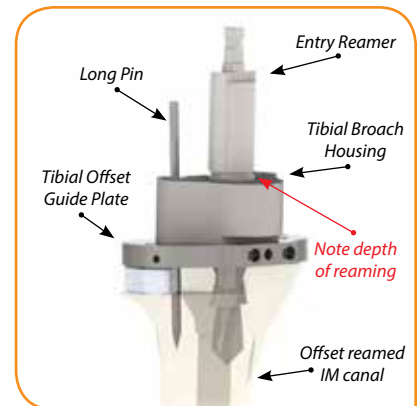

Figure T9b: Tibial Keel Reaming (Offset to be performed)

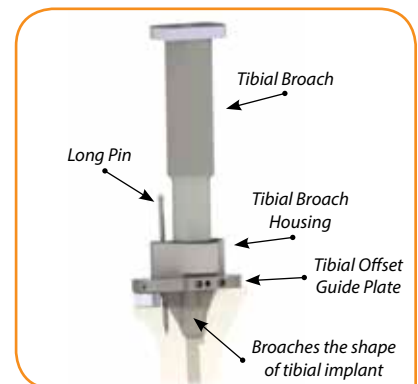

Figure T10: Broaching Tibial Keel

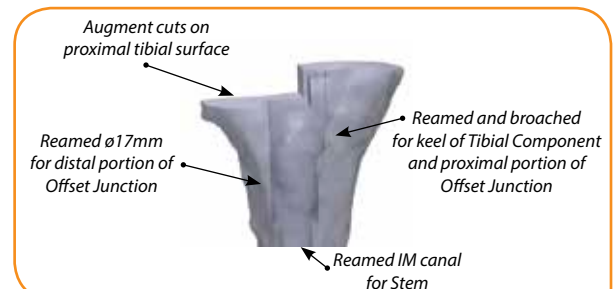

Figure T11: Prepared Tibia (shown as for cases of offset)

PCK FEMORAL PREPARATION

STEP 1: Sizing the Femur

Determine the size of revision femur to be implanted. The removed primary implant is a useful reference, and the **femoral profile guides** (Fig. F1) can also be used to visualize the fit of each size.

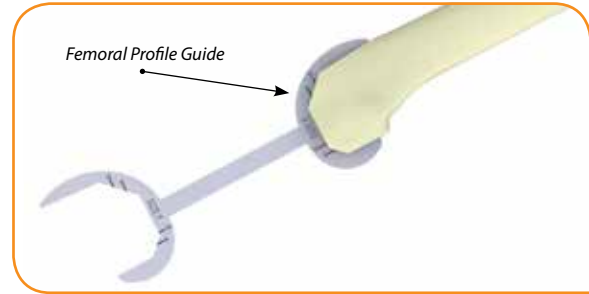

Figure F1: Sizing of the Femur

STEP 2: Reaming IM Canal

Remove cancellous bone to accommodate the stem extension.

Consult Table A at right to determine the reamer depth marking corresponding to the stem extension to be implanted. Ream the intramedullary (IM) canal with a sharp-tipped **distal reamer** (ø6.5mm or ø9mm). Ream angled anteriorly and until the appropriate depth marking reaches the distal surface of the femur (Fig. F2). (Be sure to reduce this reaming depth accordingly if the distal face will be augmented). Progressively increase reamer diameter in 0.5mm increments until the desired cortical bone contact is achieved. The ultimate **distal reamer** and **stem implant** diameters should match when uncemented. If cementing the stem, the **reamer** diameter should be 0.5mm or 1mm larger than that of the stem.

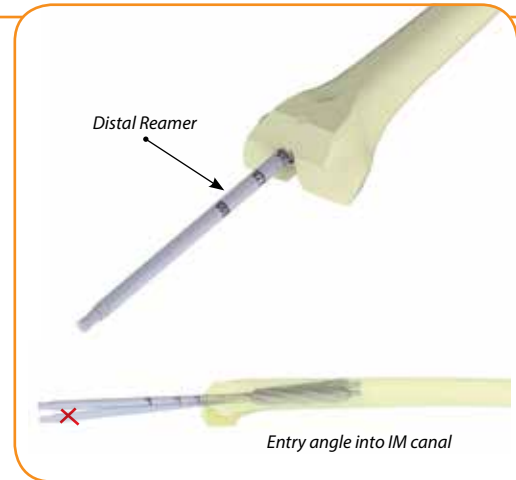

Figure F2: Reaming IM canal

TABLE A
FEMORAL IM CANAL REAMING DEPTH REQUIREMENTS

STEM LENGTH	REAMER DEPTH MARKING	
	No Offset	With Offset
40mm	65	100
75mm	100	130
100mm	130	155
150mm	175	205

NOTE

The reamed depth of the IM canal increases if the femoral component is to be offset, see Table A at right. If the need to offset the femoral is undetermined at this time, the additional depth can be reamed later.

STEP 3: Distal Femoral Cut and Valgus Angle Preparation

Refine the distal femoral face after primary implant removal to improve the bone's interface with instruments and implant. The depth of resection should be minimized to preserve bone stock. If necessary, remove deficient bone to be replaced with distal femoral augmentation blocks.

Subsequent instrumentation uses the $\varnothing 9\text{mm}$ shaft of the **distal reamer** as a positioning reference. However, in the case of a narrower $\varnothing 7.5\text{mm}$ stem, the **IM 9mm tibial alignment rod** must replace the **reamer** to provide the required $\varnothing 9\text{mm}$ reference shaft. This rod can also be used for a $\varnothing 9\text{mm}$ stem, if preferred.

To position the **Distal Femoral Cutting Guide Jig (DFCG jig)**, slide the 6° angle block over the engaged **distal reamer**, oriented according to the correct operative side.

NOTE

The Freedom Knee® PCK femoral has a fixed 6° valgus angle.

Snap the **DFCG jig** onto the **adapter** and insert the **adapter** into the slot of the 6° angle block marked 'Revision.' Set the resection level by laying the **6° angle block** against the distal face of the femur (Fig. F3) and then securing the **DFCG jig** to the bone using **long pins**. Use the **angel wing** to visualize the resection plane and assess the need for any medial or lateral distal augmentation. Resection depth can be adjusted by 2mm distally or proximally by using the $\pm 2\text{mm}$ pin holes in the DFCG jig.

To maintain the correct joint line when both medial and lateral augmentation is needed, use the **U-plate** to position the resection plane above the femoral surface. In this case, insert the **U-plate** through the appropriate **DFCG jig** augment slots (+5, +10 or +15) and lay the **U-plate** against the distal face of the femur before securing the **DFCG jig** to the bone with **long pins** (Fig. F4).

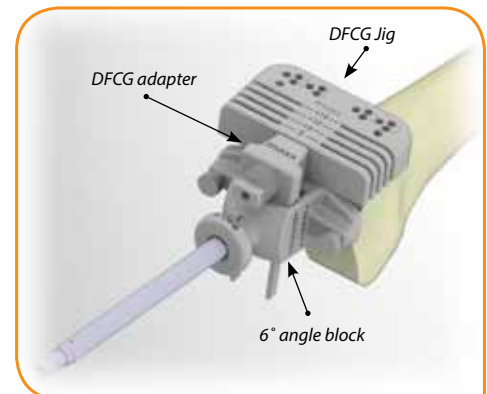

Figure F3: Assembling Distal Femoral Cut Guide

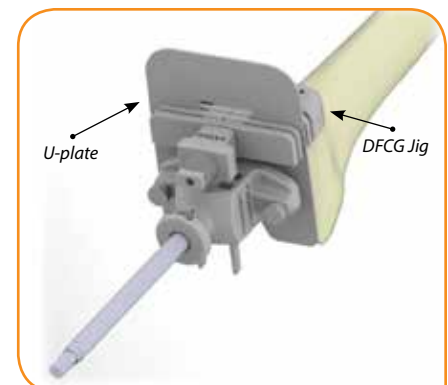

Figure F4: Assembling Distal Femoral Cut Guide with both medial and lateral augmentation

Once the **DFCG jig** is secure, detach the adapter and remove it along with the **6° angle block**. If there is bone close to or surrounding the **distal reamer** that also needs clearing, remove the **distal reamer** before resecting. Make the distal femoral cut using an **oscillating saw** through the neutral 0mm slot in the **DFCG jig** if no augmentation is necessary. Saw through the +5mm, +10mm or +15mm augment slots, independently on the medial and lateral sides, to prepare the femur to accept 1, 2 or 3 femoral distal augments, respectively. Differing amounts of distal augmentation is acceptable between the medial and lateral sides. Posterior augmentation will be addressed in the next step.

NOTE

Femoral distal and **femoral posterior augments** address distal and posterior condylar defects and are optional for use with the PCK femoral component. They are symmetric to address both medial and lateral defects and are each 5mm thick. Femoral augments, *on the distal face*, may be stacked up to three high to correct defects from 5mm to 15mm. Femoral augments, *on the posterior face*, may be stacked up to two high to correct defects of 5mm and 10mm. However, the maximum number of distal and posterior augments combined *per side* is four; i.e. if three distal augments are used on the medial side, then at most one posterior augment may be used on that same side.

STEP 4: Preparation for Anterior and Posterior Cuts

Refine the anterior and posterior femoral cuts, including posterior augmentation cuts, if necessary. Assess the need for offsetting the femoral component with respect to the IM canal.

Reintroduce the **distal reamer** into the IM canal if it was removed to perform the distal femoral resection. Select the size of **femoral A/P positioning guide** that matches the implant size. The medial/lateral width of each guide is the same as the medial/lateral width of its corresponding femoral component. If the distal face was prepared for augmentation in the previous step, **femoral augments** can be attached to the **femoral A/P positioning guide** to increase the stability of the guide on the distal face (Fig. F5). Medial and/or lateral side and thickness of augments should match the previously made femoral distal augment cuts. **Femoral augments** are supplied in two footprints, the smaller of which to be used with the size B, C or E **positioning guide** and the larger of which to be used with the size F, G or H **positioning guide**. Each set contains thicknesses of 5, 10 and 15mm.

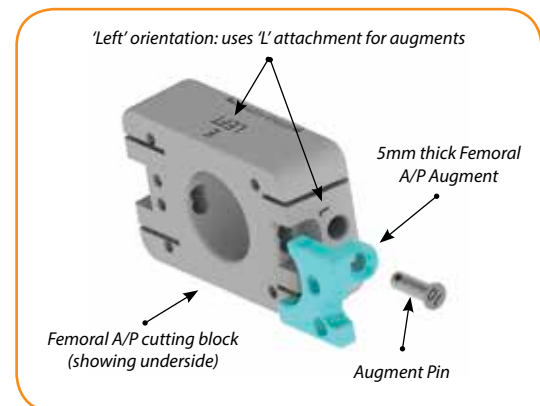

Figure F5: Assembling Femoral A/P Positioning Guide and Augments

Using the **10mm trial augment pin**, attach the appropriate size and thickness of augment(s) to the **positioning guide** through the holes on the sides of the guide according to operative side (holes marked "L" for a left knee and "R" for a right knee). There are clearance holes in the augments that align with the straight pinning holes in the **positioning guide**.

Drop the **femoral A/P positioning guide** over the **distal reamer**, orienting it for the correct operative side and resting it on the previously resected distal face of the femur. Slide the '0' dial over the **distal reamer** and fit it into the recess of the **femoral A/P positioning guide**. Use an **angel wing** through the anterior slot in the **positioning guide** to check its alignment with the existing anterior cut bone. Assess the medial/lateral location of the **positioning guide**, as this will be the medial/lateral placement of the **PCK femoral implant** (Fig. F6).

NOTE

If the central placement of the femoral is acceptable, proceed with pinning the guide in Step 4A. If this placement is not acceptable, the femoral will need to be offset, proceed directly to Step 4B.

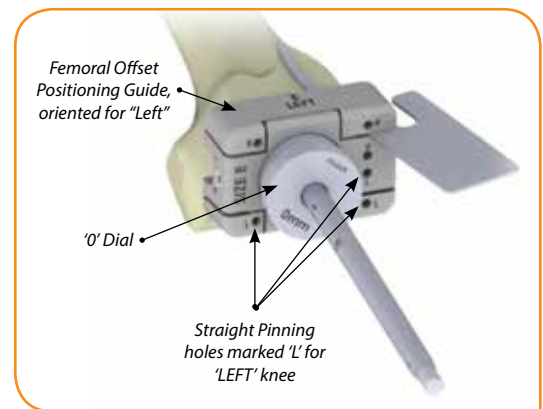

Figure F6: Assessing Central Placement of Femoral

STEP 4A: A/P Cutting Block Positioning with No Femoral Offset

[Involves either femoral A/P positioning guide and '0' dial OR femoral A/P cutting block insert instrumentation]

With the **femoral A/P positioning guide** assembled to the femur using the '0' dial, proceed to pin the guide as follows. There are three holes available per operative side for pinning the **femoral A/P positioning guide** on the distal cut face of the femur. Insert **long straight pins** through at least 2 of the 3 holes; marked as "L" for a left knee or "R" for a right knee (Fig. F6). Remove the '0' dial and the **femoral A/P positioning guide**, leaving behind the **distal reamer** and **straight pins**. Proceed directly to Step 5A: 'Assembling Femoral A/P Cutting Block'.

Alternatively, the **femoral A/P cutting block** can be positioned for no offset directly (without the use of the **femoral A/P positioning guide**) using the **femoral A/P cutting block insert** as shown at right (Fig. F7). Prepare the appropriate size **femoral A/P cutting block** with the same femoral augments used on the **femoral A/P positioning guide**. Attachment of the femoral augments is done through holes in the sides of the cutting block using the 10mm trial augment pins. Slide the femoral A/P cutting block over the distal reamer and against the distal cut bone. Slide the femoral A/P cutting block insert over the reamer and into the recess in the cutting block, oriented per operative side.

Reaffirm the location of the anterior cut using an **angel wing** through the anterior cut slot, ensuring that the anterior cut is not too deep as to notch the anterior cortex of the femur. Reaffirm the medial/lateral position of the **cutting block** for optimal coverage, understanding that the width and location of the **cutting block** will exactly match the width and location of the **femoral PCK implant**. Secure the **cutting block** to the bone with **threaded headed pins** through its oblique holes.

After securing the **femoral A/P cutting block**, proceed directly to Step 5B: 'Performing Anterior and Posterior Cuts, Including Augment Cuts'.

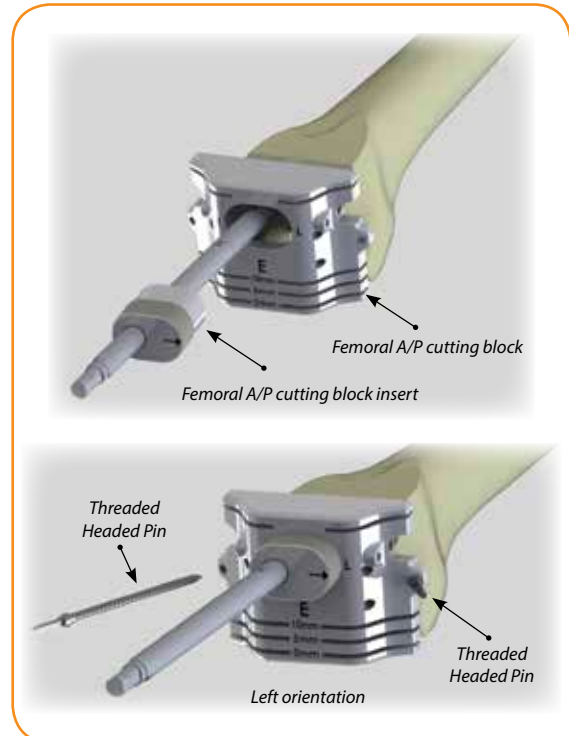

Figure F7: Positioning Femoral A/P Cutting Block (NO offset)

STEP 4B: A/P Cutting Block Positioning with Femoral Offset
[Involves femoral offset guide plate and offset dial instrumentation]

If the decision is made to offset/reposition the **femoral component**, check the **distal reamer** depth in the IM canal against the values in Table A under the column “with offset”, at right. If needed, ream the additional depth as reported in this table. (Be sure to reduce this reaming depth accordingly for any augment cuts already performed on the distal face).

With the **femoral A/P positioning guide** over the **distal reamer**, replace the “0” dial with the “left” or “right” **femoral 4mm offset dial**, according to operative side. Rotate the dial around the **distal reamer** to reposition the guide in an acceptable anterior/posterior location. Use an **angel wing** through the anterior slots as a guide, understanding that this indicates the final position of the anterior surface of the **PCK femoral implant** (Fig. F8). Also, the medial/lateral location of the **positioning guide** will be the medial/lateral location of the **PCK femoral implant**.

Proceed to pin the guide as follows. There are three holes available per operative side for pinning the **femoral A/P positioning guide** on the distal cut face of the femur. Insert **long straight pins** through at least 2 of the 3 holes; marked as “L” for a left knee or “R” for a right knee (Fig. F9).

Remove the **femoral offset dial** and the **femoral A/P positioning guide**, leaving behind the **distal reamer** and **straight pins**. Proceed directly to Step 5A: ‘Assembling Femoral A/P Cutting Block’.

TABLE A
FEMORAL IM CANAL REAMING DEPTH REQUIREMENTS

STEM LENGTH	REAMER DEPTH MARKING	
	No Offset	With Offset
40mm	65	100
75mm	100	130
100mm	130	155
150mm	175	205

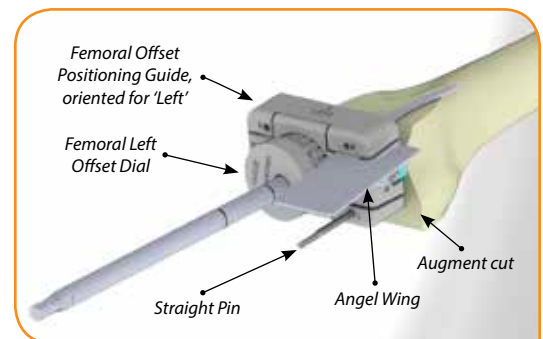

Figure F8: Positioning Femoral A/P Cutting Block (Offset to be performed)

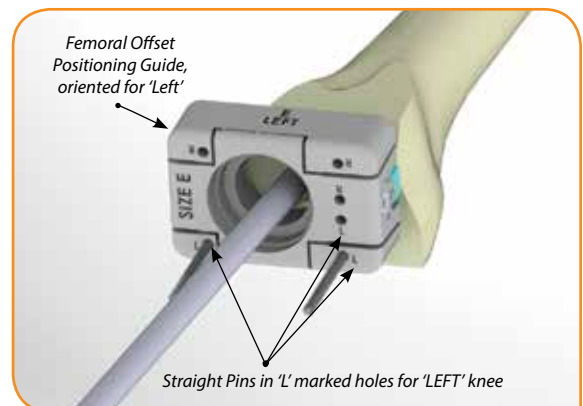

Figure F9: Pinned A/P Positioning Guide

STEP 5A: Set Up of Femoral Anterior/Posterior Cutting Block

Prepare the appropriate size **femoral A/P cutting block** with the same **femoral augments** used on the **femoral A/P positioning guide**. Attachment of the **femoral augments** is done through holes in the sides of the **A/P cutting block** using the same **10mm trial augment pins**.

Each cutting block has 4 straight pinning holes in the exact configuration as its corresponding **femoral A/P positioning guide** (which possesses 3 of these 4 holes). Slide the **femoral A/P cutting block** over the **straight pins** through the appropriate pinning holes, resting it on the cut distal face of the femur (Fig. F10).

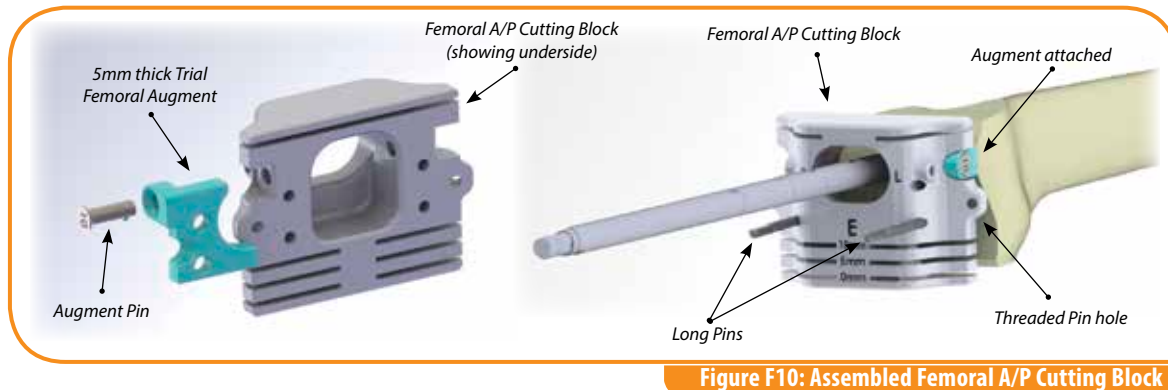

Figure F10: Assembled Femoral A/P Cutting Block

Reaffirm the location of the anterior cut using an **angel wing** through the anterior cut slot, ensuring that the anterior cut is not too deep as to notch the anterior cortex of the femur. Reaffirm the medial/lateral position of the cutting block for optimal coverage, understanding that the width and location of the cutting block will exactly match the width and location of the **femoral PCK implant**. Secure the **femoral A/P cutting block** to the bone with **threaded headed pins** through its oblique holes.

Proceed with Step 5B: 'Performing Anterior and Posterior Cuts Including Augment Cuts'.

STEP 5B: Performing Anterior and Posterior Cuts, Including Augment Cuts

Visualize the anterior and posterior cuts using the **angel wing**. Ensure that anterior notching will be avoided and assess the need for posterior augmentation. Make the anterior and posterior cuts using an **oscillating saw** through the appropriate cutting slots in the **femoral A/P cutting block**. For the posterior cuts, use the '0mm' slots if no augmentation is needed or use the '5mm' or '10mm' augment slots to remove bone for 1 or 2 augments, respectively, as required. The maximum number of posterior augments per side is two.

NOTE

The maximum number of distal and posterior augments combined per side is four. Therefore, two posterior augments may be used on a particular side only if two or fewer distal augments are used on that same side; again adding up to a combined maximum number of four augments per side.

Remove the **femoral A/P cutting block** and proceed with Step 6: 'Preparation for Intercondylar Box Cuts'.

STEP 6: Preparation for Intercondylar Box Cuts*Assembling and positioning of the PCK box cut guide (BCG)*

Select the size of **femoral PCK box cut guide (BCG)** that matches the implant size. The medial/lateral width each guide is the same as the medial/lateral width of its corresponding femoral component. If the distal face was prepared for augmentation, **distal femoral augments** can be attached to the **BCG** to increase the stability of the guide on the distal face. Medial and/or lateral position and thickness of augments should match the previously made femoral distal augment cuts. There is one **distal femoral augment** for all sizes of box cut guides available in thickness of 5, 10 or 15mm. The proper orientation of the **distal femoral augments** will ensure no interference with the subsequent box and chamfer cuts. Attach the appropriate thickness augment to the distal face of the **BCG** using the corresponding length of **trial augment pin** (Fig. F11).

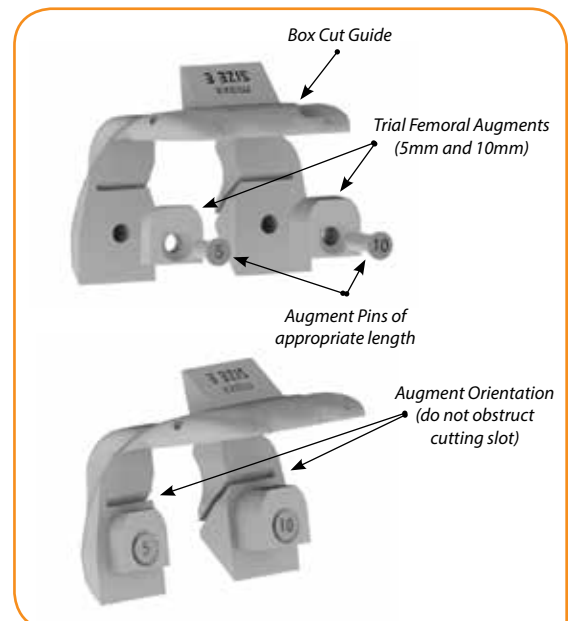

Figure F11: Assembling Femoral BCG and Augments

NOTE

If there is no femoral offset, position the BCG as per Step 6A. Otherwise, if the femoral A/P cutting block was positioned to offset the femoral, proceed directly to Step 6B: 'Positioning the PCK Box Cut Guide (BCG) for Offsetting the Femoral'.

STEP 6A: Positioning the PCK Box Cut Guide (BCG) with No Femoral Offset
[Involves femoral drill guide housing and reducer instrumentation]

Reintroduce the original **distal reamer** into the IM canal if it was previously removed (diameter which matches the stem to be implanted). Select and attach the appropriate size **femoral drill guide housing**, small (B-E) or large (F-H), to the **BCG**, oriented according to the correct operative side. Drop the assembly over the **distal reamer** and position it flush against the anterior and distal faces of the resected femur (Fig. F12).

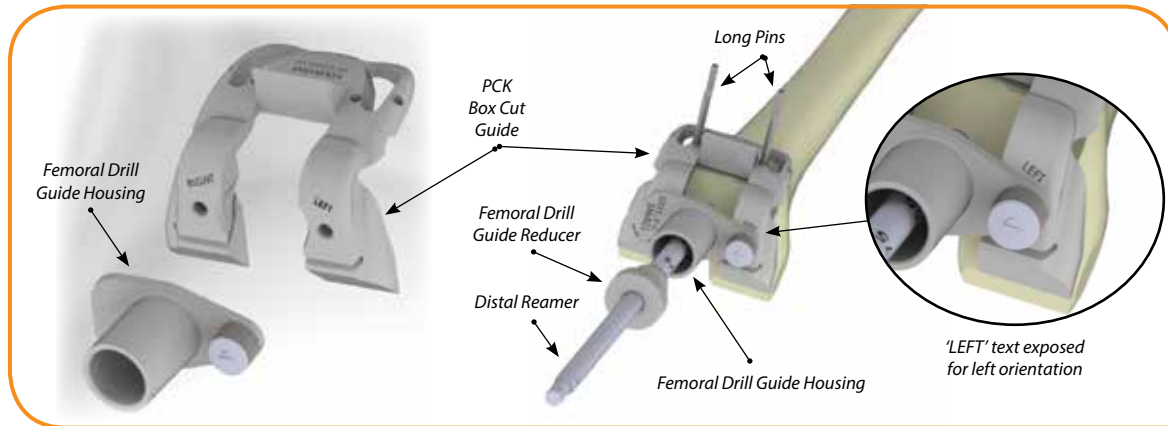

Figure F12: Positioning Box Cut Guide (NO offset)

Slide the **femoral drill guide reducer** over the **distal reamer** and into the boss of the **femoral drill guide housing**. The **femoral drill guide reducer** accepts the $\varnothing 9.0\text{mm}$ of the **distal reamer** and is needed to correctly position the **BCG** when no femoral offset is performed. Secure the **BCG** using **long pins** through the straight holes on its anterior face (use the most distal set of straight holes if multiple sets exist).

Remove the **femoral drill guide reducer** and **drill guide housing** and note the following prior to extracting the **distal reamer**.

NOTE

If the **distal reamer** diameter exceeds those listed in the table at right corresponding to the femoral implant size, it is necessary to temporarily remove the **BCG** from the **long pins** prior to extracting the **distal reamer**. After removing the **distal reamer**, reassemble the **BCG** onto the **long pins** before proceeding.

TABLE B. MAXIMUM REAMER \varnothing VS. FEMORAL IMPLANT SIZE

FEMORAL IMPLANT SIZE	REAMER \varnothing
B	$\varnothing 17.5\text{mm}$
C	$\varnothing 18.0\text{mm}$
E	$\varnothing 18.0\text{mm}$
F	$\varnothing 22.0\text{mm}$
G	$\varnothing 22.0\text{mm}$
H	$\varnothing 22.0\text{mm}$

After extracting the **distal reamer**, additional pins can be used through the oblique holes to further secure the **BCG**. With only the pinned **BCG** remaining, proceed directly to Step 7: 'Performing Central Boss Reaming and Intercondylar Box Cuts'.

STEP 6B: Positioning the PCK Box Cut Guide (BCG) with Femoral Offset [Involves femoral BCG offset plate and offset dial instrumentation]

Opening IM canal to accept femoral offset component:

If offsetting the femoral and the IM canal is reamed to a diameter smaller than $\varnothing 17\text{mm}$, additional reaming is necessary to prepare the femur to accept the proximal portion of the offset junction in line with the IM canal.

Remove all instrumentation including the current **distal reamer**. Using the **$\varnothing 17\text{mm}$ distal reamer** and following the previously reamed IM canal, ream until the 65mm mark on the reamer is flush with the distal face of the femur. (Be sure to reduce this reaming depth accordingly for any augment cuts already performed on this distal face).

Positioning the BCG:

Reintroduce the original **distal reamer** into the IM canal if it was previously removed (diameter which matches the stem to be implanted). Take the prepared **BCG** (refer to Fig. F11) and depending on implant size, attach the small (B-E) or large (F-H) **femoral BCG offset plate** to the **BCG**, oriented according to the correct operative side (Fig. F13).

Drop the **BCG** assembly over the **distal reamer**. Initially, position it flush against the anterior and distal faces of the resected femur. Slide the appropriate "left" or "right" **femoral offset dial** over the **distal reamer** and fit it into the recess of the **femoral BCG offset plate** (Fig F14). Rotate the **offset dial** around the **distal reamer** to position the **BCG** in the appropriate location. Two situations can occur:

- Ideally, the internal anterior face of the **BCG** rests on the anterior cut of the femur and an acceptable medial/lateral placement is found. Recall, that in positioning the **femoral A/P cutting block** to make the anterior and posterior cuts, this medial/lateral position was assessed and therefore should be correct.

OR

- The internal anterior face of the **BCG** is not resting on the anterior cut of the femur, but rather is floating off the bone. In this case, offsetting of the femoral is most likely anterior with respect to the IM canal. This can happen if the explanted femoral was placed too far posterior and/or too much anterior bone was resected during the previous surgery. Understand that if you desire to finalize the position of the **BCG** as such, you will need to recut the posterior face of the femur accordingly, as well as fill this resulting anterior gap with bone cement.

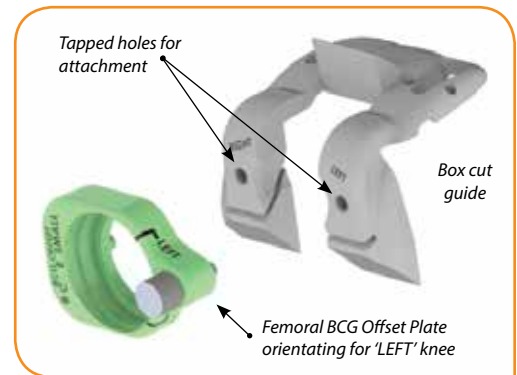

Figure F13: Femoral PCK Box Cut Guide with Femoral BCG Offset Plate

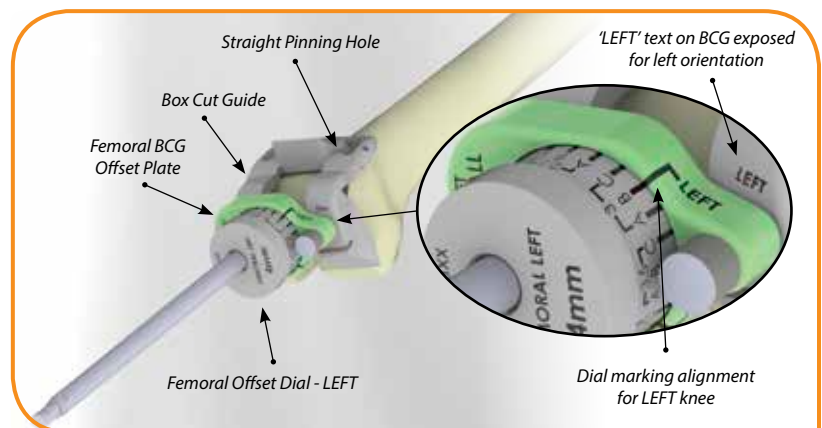

Figure F14: Offset Positioning of Femoral PCK Box Cut Guide

Pin the **BCG** with long straight pins through the straight anterior pinning holes. Be mindful to avoid pinning holes that may interfere with the reamer, especially in situations where offsetting is mostly in the medial or lateral direction. The oblique pinning holes can be used later for further fixation.

Record which marking on the **offset dial** is aligned with the corresponding mark on the **femoral BCG offset plate** (Fig. F14).

NOTE

Recording the offset dial marking that aligns with the marking on the **BCG offset plate** (in this case, '3 B') aids in later assembling the trial and implant components correctly.

Disassemble the instrumentation as follows. First, remove the **femoral offset dial** and **BCG offset plate**. Prior to extracting the **distal reamer**, temporarily remove the **BCG** from the **long pin** or **pins** securing it. Extract the **distal reamer** and then replace the **BCG** on the **pin(s)**. At this point, additional pins can be used through the straight or oblique holes to further secure the **BCG**. With only the pinned **BCG** remaining, proceed with Step 7: 'Performing Central Boss Reaming and Intercondylar Box Cuts'.

STEP 7: Performing Central Boss Reaming and Intercondylar Box Cuts

Remove intercondylar bone to accommodate the femoral boss and intercondylar box of the PCK femoral implant as well as the distal end of the optional offset junction component.

Follow the appropriate description below regarding Central Boss Reaming: 7A for no femoral offset and 7B for cases with femoral offset.

STEP 7A: Central Boss Reaming in Cases with No Femoral Offset

NOTE

If the **distal reamer** used is $\varnothing 17\text{mm}$ or larger, central boss reaming is not needed. Proceed directly to the next section titled 'Intercondylar box cuts'.

If the **distal reamer** used is less than $\varnothing 17\text{mm}$, the femur must be prepared to accept the central boss of the PCK component. Re-attach the appropriate size **femoral drill guide housing** [small (B-E) or large (F-H)] to the pinned **BCG**, oriented according to the correct operative side. Pins can be introduced through the oblique set of holes in the **BCG** for additional fixation. Advance the **entry reamer** through the **femoral drill guide housing** until the proximal end of the reamer reaches the top of the **femoral drill guide housing** (Fig. F15a). Remove the **entry reamer** and **femoral drill guide housing**, leaving the **BCG** in place for the subsequent box and chamfer cuts. Proceed directly to Step 7C: 'Intercondylar Box Cuts and Chamfer Cuts'.

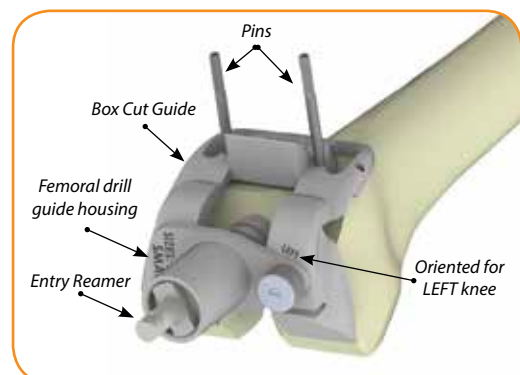

Figure F15a: Reaming Central Boss (NO Offset)

NOTE

Alternatively, the **Ø17mm distal reamer** can be used in place of the **entry reamer**. Reaming until the 100mm groove is about 15mm shy of the top of the **femoral drill guide housing** replicates the depth achieved using the **entry reamer**.

STEP 7B: Central Boss Reaming in Cases with Femoral Offset**NOTE**

Central boss reaming is always needed in cases where the femoral is offset.

Prepare the femur to accept not only the central boss of the PCK femoral component, but also the distal portion of the offset junction component. Attach the appropriate size **femoral drill guide housing** [small (B-E) or large (F-H)] to the pinned **BCG**, oriented according to the correct operative side. Pins can be introduced through the oblique set of holes in **BCG** for additional fixation. Advance the **Ø17mm distal reamer** through the **femoral drill guide housing**, reaming until the 100mm groove reaches the top of the **femoral drill guide housing** (Fig. F15b). Remove the **distal reamer** and **femoral drill guide housing**, leaving the **BCG** in place for the subsequent box and chamfer cuts. Proceed directly to Step 7C: 'Intercondylar Box Cuts and Chamfer Cuts.'

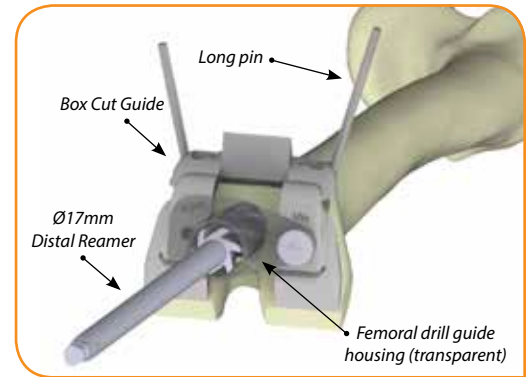

Figure F15b: Reaming Central Boss (Offset to be performed)

STEP 7C: Intercondylar Box Cuts and Chamfer Cuts

For this step, ensure that the pinned **BCG** is the only instrumentation present. With a **reciprocating saw**, use the three centralized surfaces of the **BCG** to aid in making the box cuts on the distal femur (Fig. F16). Be careful not to risk fracture by undermining the medial or lateral condyles. Use an **oscillating saw** through the cutting slot in the **BCG** to perform the anterior chamfer resection. Guide the saw along the posterior angled faces of the **BCG** to perform the posterior chamfer resection.

Remove all instrumentation in preparation for trialing.

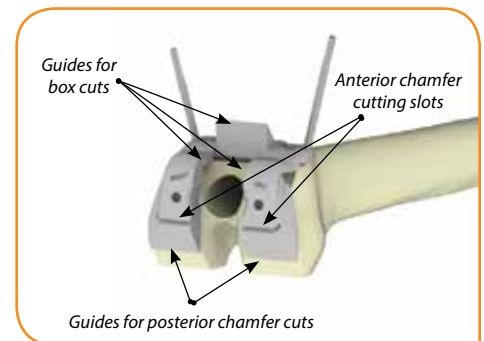

Figure F16: Performing Box Cuts

TRIALING

Trialing the PCK Femoral Components

Select the size of **femoral trial** that matches the size to be implanted. Optional components include a **stem extension trial**, **femoral augment trials** and **4mm offset junction trial**.

If needed, attach the appropriate size and thickness of **femoral trial augment(s)** with the appropriate length **augment pins(s)** to the **femoral trial** (Fig. I1). The thickness and placement of the **femoral trial augment(s)** is dictated by the femoral distal and posterior augment cuts previously made.

If not offsetting, thread and hand tighten the appropriate diameter and length **stem extension trial** into the **femoral trial** (Fig. I2a).

If offsetting, thread and hand tighten the appropriate diameter and length **stem extension trial** into the **4mm offset junction trial**. Thread the **offset junction trial** into the central boss of the **femoral trial** until the **offset junction trial** can spin freely (Fig. I2b).

Align the **femoral trial** and **offset junction trial** markings according to the rotational position recorded earlier between the **femoral BCG offset plate** and the **femoral offset dial** (refer to Step 6B and Fig. F14, page 19, under the PCK Femoral Preparation for offset marking). Secure this orientation by inserting the **PCK junction screw** through the hole in the **femoral trial** and threading it into the **offset junction trial** (Fig. I3).

Alternatively, the trial assembly shown in Fig. I2b can first be impacted in place, prior to inserting the screw. This allows the **offset junction** to rotate freely and the assembly to find its natural position in the prepared bone. For this alternative method, as the last step, lock the orientation of the assembly by inserting the **junction screw** as previously mentioned. After extracting the trial assembly, be sure to record the marking value that aligns the **offset junction** to the **femoral trial**. This marking should be used in assembling the implant components even though it may vary slightly from the one determined during the instrumentation stage.

This value is imperative to assemble the implant components in the same orientation as the trial components.

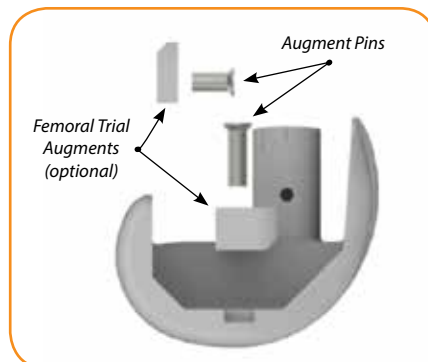

Figure I1: Attaching Femoral Trial Augments

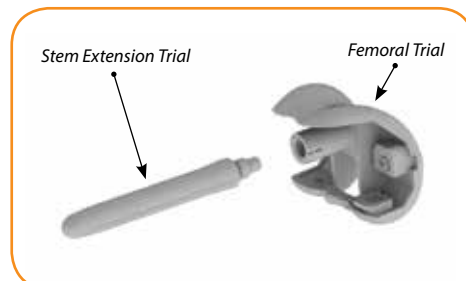

Figure I2a: Attaching Femoral Stem Trial (No offset)

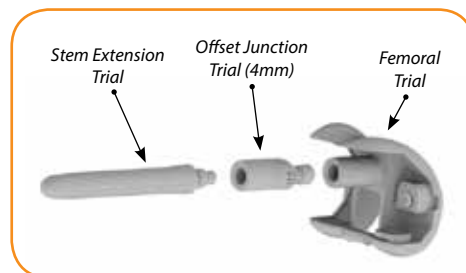

Figure I2b: Attaching Femoral Stem Trial and Offset Junction Trial

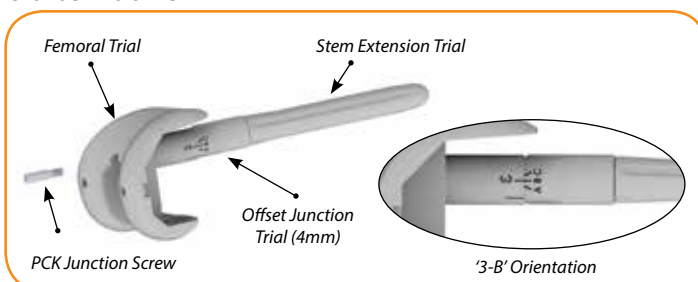

Figure I3: Securing Femoral Offset Positioning

NOTE

The **femoral trial** has the numbers '1', '2' and '3' laser etched on the circumference of the boss with corresponding laser etched lines respectively for 1, 1.5, 2, 2.5 and 3. Regardless of whether the femoral is a LEFT or a RIGHT component, the '1' is located on the medial side of the boss and the '3' is on the lateral side of the boss.

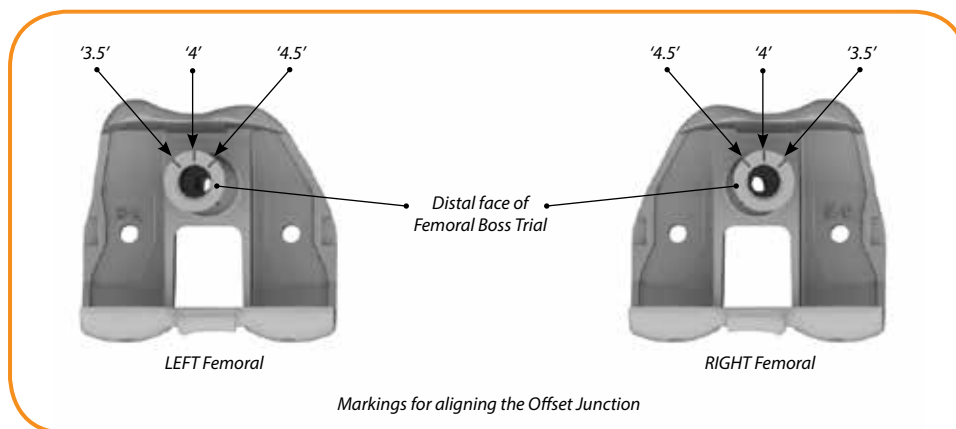

Figure I4: Femoral Trial Offset Markings

NOTE

The laser etched lines respectively for 3.5, 4 and 4.5 are located on the flat distal face of the boss. No numbers accompany these three lines (Fig. I4). Note the locations of these markings on the LEFT and RIGHT femorals shown here.

Place and impact the **femoral trial assembly** into the prepared femur using a **femoral impactor**. Using a **tibial alignment guide**, reduce the knee to estimate the tibial liner thickness (Fig. I5).

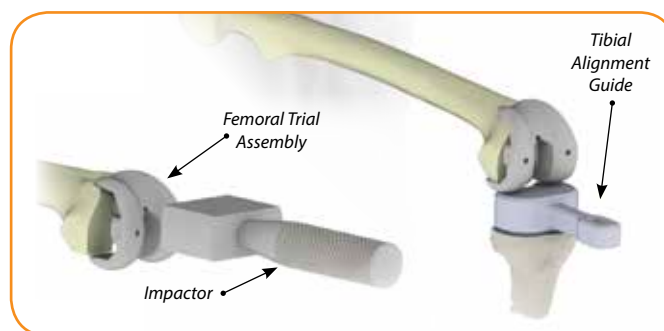

Figure I5: Impacting Femoral Trial and Estimating Tibial Liner Thickness

Trialing the Stemmed Tibial Components

Select the appropriate sizes of the **stemmed tibial tray trial** and **stem extension trial** components that match the sizes to be implanted. Optional components include an **offset junction trial** and **tibial augment trials**.

If the proximal tibial face was previously prepared for augmentation, secure **tibial augment trial(s)** to the distal surface of the **stemmed tibial tray trial** with the appropriate length **augment screw(s)** (Fig. I6). The number and size of **augment trials** per side is determined by the previously made tibial augment cuts. Stacked multiple **tibial augment trials** can be of the same size or in descending sizes. The lugs on the **tibial augment trials** are used to aid their alignment and placement. Thread the **augment screw(s)** fully through each augment before stacking and threading the screw through the next augment. Hand tighten the screw(s) using a **2mm hex driver** to lock the **augment(s)** to the **stemmed tibial tray trial**.

If not offsetting, thread and hand tighten the **stem extension trial** into the keel of the **stemmed tibial tray trial** (Fig. I7a).

If offsetting, thread and hand tighten the **stem extension trial** into the distal end of the **offset junction trial**. Thread the proximal end of the **offset junction trial** into the keel of the **stemmed tibial tray trial** until the **offset junction trial** can spin freely (Fig. I7b). Align the **stemmed tibial tray trial** and **offset junction trial** markings according to the rotational position recorded earlier between the **tibial offset guide plate** and the **offset dial** (refer to Step 4 and Fig. T8, page 8, under the Stemmed Tibial Preparation for offset marking). Secure this orientation by inserting the longest **augment screw (15mm)** through the hole in the **stemmed tibial tray trial** and threading it into the **offset junction trial** (Fig. I7b).

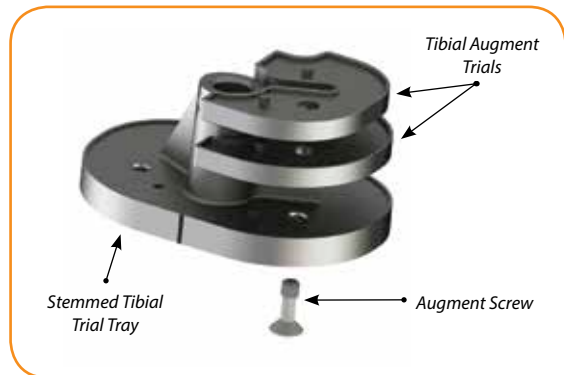

Figure I6: Attaching Tibial Augment Trials

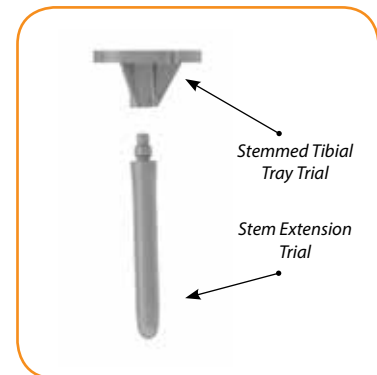

Figure I7a: Attaching Tibial Stem Trial (No offset)

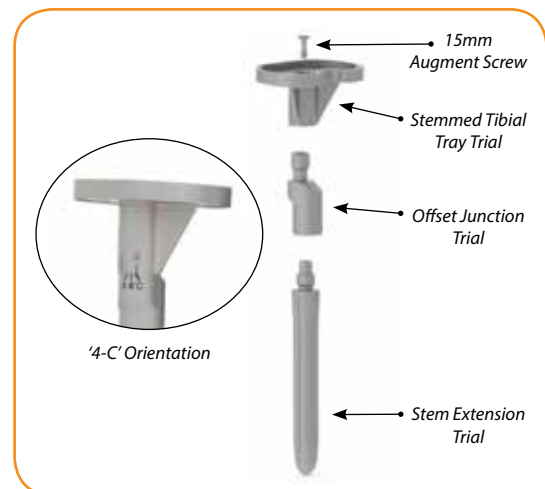

Figure I7b: Attaching Tibial Stem Trial and Offset Junction Trial

Alternatively, the trial assembly of the **stemmed tibial tray**, **offset junction** and **stem extension trial** can first be impacted in place, prior to inserting the screw. This allows the **offset junction** to rotate freely and the assembly to find its natural position in the prepared bone. For this alternative method, as the last step, lock the orientation of the assembly by inserting the **augment screw** as previously mentioned. After extracting the trial assembly, be sure to record the marking value that aligns the **offset junction** to the **stemmed tibial tray trial**. This marking should be used in assembling the implant components even though it may vary slightly from the one determined during the instrumentation stage. **This value is imperative to assemble the implant components in the same orientation as the trial components.**

Impact the **tibial trial assembly** into the resected and prepared tibia (Fig. I8).

Select the appropriate size **PS tibial trial liner** or **PCK tibial trial liner** "top" and snap it together with the appropriate size and desired thickness of the **tibial trial liner** "base." (Tops are available in sizes B thru H; select the letter size that matches the femoral size. Bases are available in sizes 1 thru 8; select the number size that matches the tibial tray size. Each base is available in thicknesses of 11 thru 31mm). Fit the liner components into the recess in the **stemmed tibial tray trial** (Fig. I9). The approximate liner thickness was estimated earlier using the **tibial alignment guide**. Multiple **trial liner base** thicknesses can be trialed here to obtain the correct balance during reduction of the knee.

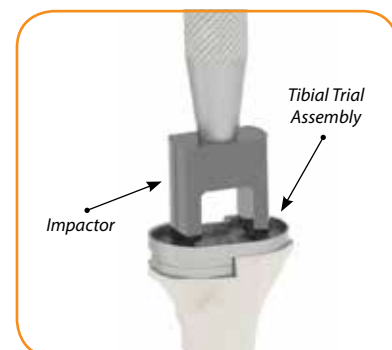

Figure I8: Impacting Tibial Trial



Figure I9: Inserting Tibial Trial Liner

Trialing the Patella

Refer to Freedom Total Knee® System Surgical Technique (MXO-MP00005) for information on the preparation and trialing of the patella.

Trial Reduction and Gap Balancing

Perform a trial reduction of all the components (Fig. I10). Check alignment, varus/valgus stability, extension, patellofemoral tracking, anteroposterior stability, and flexion degrees. Use a gap balancing chart to adjust and modify any imbalance in the knee. Soft tissue releases can be performed as necessary to allow for fine tuning the tension in extension and flexion.

Once satisfied with their performance, remove the femoral and tibial trial assemblies. Take note of all components, their respective sizes, the **tibial trial liner** thickness, and the coordinated markings between the **offset junction** and **stemmed tibial tray trial** and between the **offset junction** and **femoral trial**. These markings should closely match those recorded earlier in the procedure. Refer to step 4 (Fig. T8) under the Stemmed Tibial Preparation and step 6B (Fig. F14) under the PCK Femoral Preparation to review the offset orientation.



Figure I10: Reduction of Knee with Trial Components

IMPLANTS

Preparing the Stemmed Tibial Implant Assembly

Prepare the **stemmed tibial baseplate** by removing the necessary plugs using care to not damage the component. The **taper hole plug** is removed using an osteotome between the plug and keel. If augmenting, the **tibial augment hole plugs** are removed by placing the **baseplate** face down on a flat surface and pushing out the plugs with the **2mm hex driver**. If a **PCK tibial liner** is to be implanted, the **central sealing plug** is unthreaded using a **2mm hex driver**.

In cases where no tibial offset is needed, there is one Morse-type taper locking mechanism with set screw between the **stemmed tibial baseplate** and **stem extension** (Fig. I11a). The **set screw** is included with the tibial component but packaged separately in its own pouch. Seat the **stem extension** firmly within the keel taper. Place the **baseplate** face down on a flat surface of the surgical cart and while protecting the **stem extension** strike it solidly once with a two-pound mallet. Use the **2mm hex key** to thread and hand tighten the **set screw** through the hole in the keel.

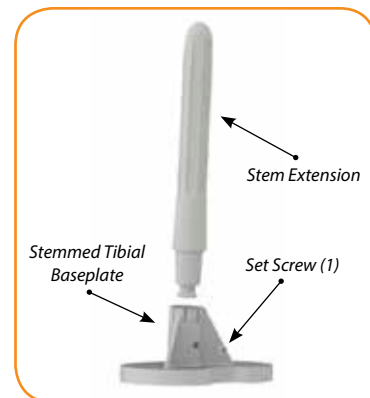

Figure I11a: Assembling Tibial Implant Components (No Tibial Offset)

In cases involving a **tibial offset junction**, there are two Morse-type taper locking mechanisms with **set screws** (Fig. I11b). The **set screws** are included with their respective components, but again packaged separately in their own pouches. Seat the **stem extension** firmly within the distal end of the **offset junction**. Properly orient the **offset junction** with respect to the **baseplate**, replicating the alignment markings determined during trialing, and firmly seat its proximal end into the keel taper of the **baseplate**. Place the **baseplate** face down on a flat surface of the surgical cart and while protecting the **stem extension** strike it solidly once with a two-pound mallet. Use the **2mm hex key** to thread and hand tighten the **set screws** through the holes in both the body of the **offset junction** and the keel of the **baseplate**.

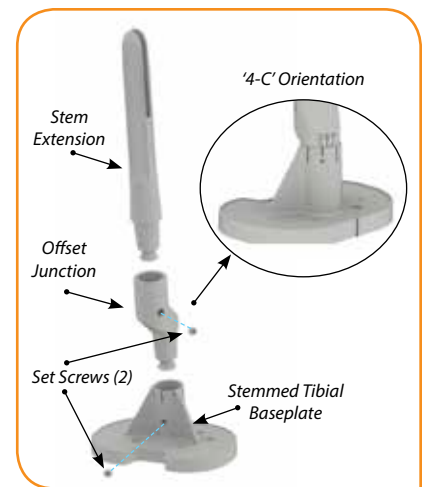

Figure I11b: Assembling Tibial Implant Components (Including Tibial Offset)

NOTE

The **set screw** in the **baseplate** must be assembled before attaching the **tibial augments** in the next step.

NOTE

Striking the stem more than once to engage the taper may loosen the taper connection.

Attach **tibial augment(s)** to the distal surface of the **stemmed tibial baseplate** with the appropriate length **augment screw** as required (Fig. I12). The lugs are used to aid alignment and placement. Thread the **augment screw** fully through each **augment** before stacking and threading it through the next **augment**. Hand tighten the screw(s) using a **2mm hex driver** to lock the **augment(s)** to the **baseplate**.

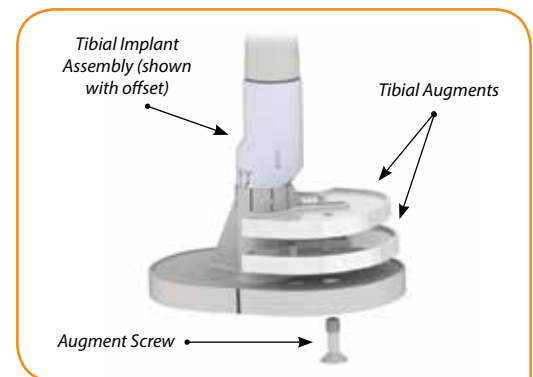

Figure I12: Attaching Tibial Implant Augments

Preparing the PCK Femoral Implant Assembly

In cases where no femoral offset is needed, there is one Morse-type taper connection with **set screw** between the **femoral implant** and optional **stem extension** (Fig. I13a). The **set screw** is included with the femoral component but packaged separately in its own pouch. Firmly seat the **stem extension** into the female taper of the **femoral implant** central boss. Protect the articulating surface of the femoral; support it against the surface of the surgical cart, and while protecting the **stem extension**, strike it solidly once with a two-pound mallet. Use the **2mm hex key** to thread and hand tighten the **set screw** through the hole in the side of the central boss.

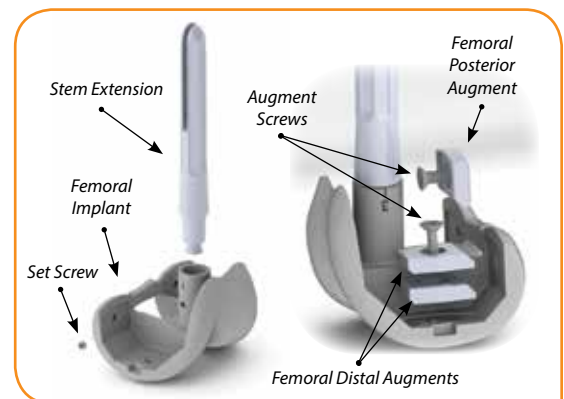

Figure I13a: Assembling Femoral Implant Components — No Femoral Offset

In cases involving a **femoral offset junction**, there are two Morse-type taper locking mechanisms with **set screws** (Fig. I13b). The **set screws** are included with their respective components, but again packaged separately in their own pouches. Seat the **stem extension** firmly within the female taper of the **offset junction**. Properly orient the **offset junction** with respect to the **femoral implant**, replicating the alignment markings determined during trialing, and firmly seat its distal end into the female taper of the **femoral implant**. Protect the articulating surface of the femoral; support it against the surface of the surgical cart, and while protecting the **stem extension**, strike it solidly once with a two-pound mallet. Use the **2mm hex key** to thread and hand tighten the set screws through the holes in both the body of the **offset junction** and the central boss of the femoral.

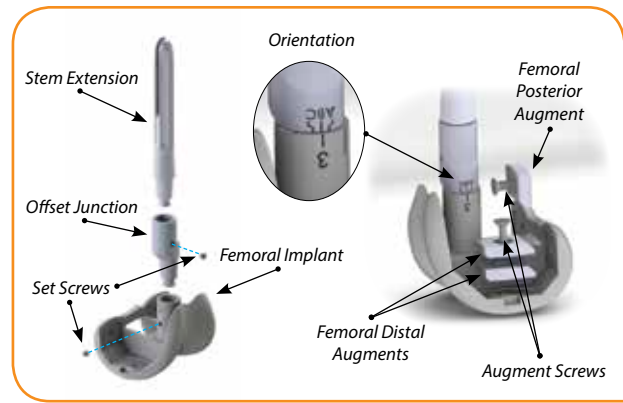

Figure I13b: Assembling Femoral Implant Components — Including Femoral Offset

Attach **posterior femoral augment(s)** and **distal femoral augment(s)** with the appropriate length **augment screw(s)** as required (Fig I13a or I13b). The number and type of **augments** should replicate that of the trial assembly.

Implantation

Using the standard mixing protocol for the bone cement, mix and prepare the bone cement for cementing the implants.

We recommend the following order of implantation.

- a) **Stemmed tibial components**
- b) **PCK femoral components**
- c) **Tibial articulating surface (tibial liner)**
- d) **Patellar component**

a) Stemmed Tibial Components

Prior to cementing, irrigate the bone surfaces and drill sclerotic areas with a **1/8" drill bit** to a depth of approximately **1/8"**. Firmly press cement into the bone surfaces, including the perimeter of the reamed keel entry hole, to allow for adequate interdigitation. Place cement on the undersurface of the **stemmed tibial baseplate** and firmly impact the assembled **stemmed tibial components** into place using the **tibial impactor** (Fig. I14). Remove excess cement. If desired, cement can also be used on the **stem extension**. In this case, the IM canal must have been reamed 0.5mm to 1mm in diameter larger than the stem diameter to be implanted (refer to Step 1 under Stemmed Tibial Preparation "Reaming IM Canal").

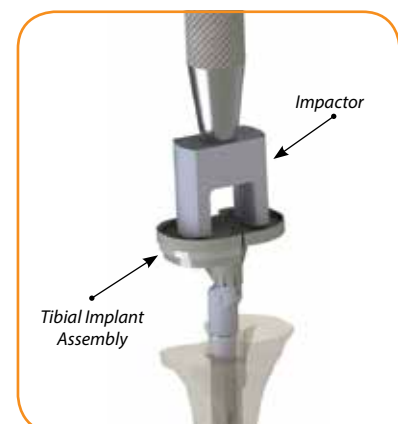

Figure I14: Impacting Stemmed Tibial Implant

b) PCK Femoral Components

Hyperflex the knee and dry the distal femoral bone cuts. Finger pressurize the posterior condyles with cement. Apply bone cement to the undersurface of the **femoral component**. Firmly impact the **femoral components** into place using the **femoral impactor** (Fig. I15). Remove excess cement. If desired, cement can also be used on the **stem extension**. In this case, the IM canal must have been reamed 0.5mm to 1mm in diameter larger than the stem diameter to be implanted (refer to Step 2 under PCK Femoral Preparation "Reaming IM Canal").

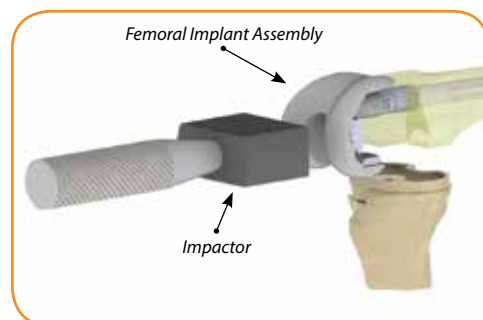

Figure I15: Impacting PCK Femoral Implant

c) Tibial Articulating Surface

Irrigate the surface of the **stemmed tibial baseplate** and remove any excess debris to clear the locking mechanism. Firmly impact the selected **PS or PCK tibial liner** into place with the **tibial impactor** and check to see that the locking mechanism is engaged (Fig. I16). In cases with a **PCK tibial liner**, use a **2mm hex driver** to advance the captured **locking screw** (currently inside the liner) into the **stemmed tibial baseplate**, securing the liner in place.

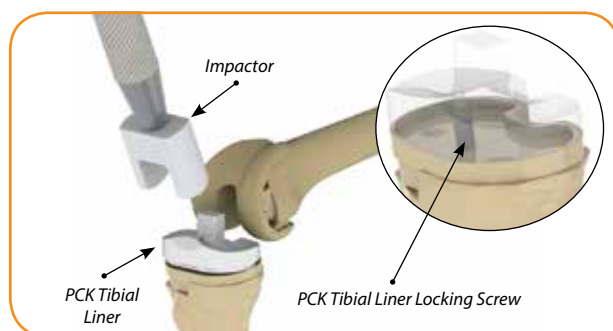

Figure I16: Impacting Tibial Articulating Surface Implant

d) Patellar Component

Refer to Freedom Total Knee® System Surgical Technique (MXO-MP00005) for information on preparation and implantation of the patella.

Closure is performed in the usual manner.

Pursue Life™

For more information about Freedom Knee® please contact your local representative or visit maxxortho.com.



SEARCH: freedom knee

Freedom Total Knee® System (PCK and Stemmed Tibia)

Rx only



Maxx Orthopedics, Inc.
2460 General Armistead Ave, Ste 100
Norristown, PA 19403 USA



RMS UK, Ltd. 28 Trinity Rd
Nailsea, Somerset BS 484NU UK

CE 2460



Carefully read all instructions and be familiar with the surgical techniques prior to use.

Please see the package insert for complete device description, product selection information, indications, contraindications, precautions, adverse effects, warnings, materials, sterilization and patient guidance associated with the Freedom Total Knee® System.

CAUTION: THIS DEVICE IS RESTRICTED TO SALE BY OR ON THE ORDER OF A LICENSED PHYSICIAN

WARNING: THIS DEVICE IS INTENDED FOR CEMENTED USE ONLY

Freedom Knee® is manufactured by Maxx Orthopedics, Inc. FREEDOM, FREEDOM KNEE, PCK, Pursue Life and Think Outside the Box are Registered Trademarks of Maxx Orthopedics, Inc.

© 2019 Maxx Orthopedics. All rights reserved. Updated January 2019.

maxx
orthopedics

www.maxxortho.com

Maxx Orthopedics Brochure No. MXO-MP0023-R04