

RXL Series

Explosion Proof Edge Lit LED Exit Sign

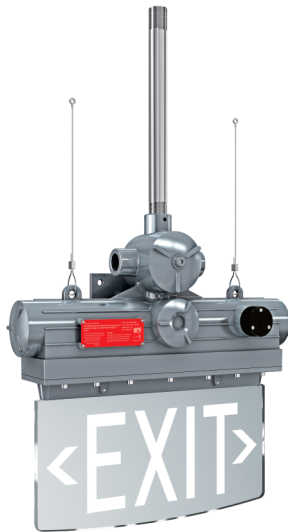

Explanation of Indicator Light:



Image: RGY three-color indicator light

- If three or two indicator lights remain on during initial power on, it is necessary to reset them by detecting the switch: press the switch "ON" for 5 to 6 seconds ->OFF ->ON.
- **RED:**
 1. Fast charging for 2 hours.
 2. Charging indicator, displaying 20% -80% battery capacity.
- **GREEN:**
 1. Trickle charging.
 2. Charging indicator, displaying 80% -100% battery capacity.
 3. Green light on when disconnecting the battery.
- **RED and GREEN:**

Red and Green flashes alternately for 5 minutes, indicating that it is at 80% battery capacity.
- **YELLOW:**
 1. Discharge below 20%.
 2. If the yellow light is on in any state, the product is out of order.

Features:

- Low energy consumption.
- 3-hour emergency operation.
- Alternate exit legend and languages available.
- Provided with 3/4" NPT or M25 conduit hubs.
- Long lifespan up to 50,000 hours.
- Edge-lit sign.
- Ingress protection rating IP66.

Two Options of Function:

- Model 1: EXIT sign remains on with or without mains electricity.
- Model 2: EXIT sign does not light up when there is mains electricity, but only lights up when there is a power outage.

Specifications:

Universal Input Voltage

100-277VAC or 100-347VAC, 50/60Hz

Rated Wattage

1W, 2W, 3W, 4W, 5W

Emergency Time

3H

Warranty

5-year limited warranty

Temperature Rating (Ambient)

14°F to +140°F (-10°C to +60°C)

Certifications:

- Marking UL844 (North American)
 - Class I, Division 1, Groups B, C, D
 - Class I, Division 2, Groups A, B, C, D
 - Class II, Division 1, Groups E, F, G
 - Class II, Division 2, Groups F, G
 - Class III
- UL924
- UL844
- UL 121201/CSA NO.213
- CSA C22.2 No.137-18

Description of Switch:

- 1. Press the switch "ON" once, the EXIT sign and indicator light will flash once, with an ON/OFF interval of 10 seconds.
- 2. With mains electricity disconnected, long press and hold the switch for 3 to 5 seconds to turn off the product. If the EXIT sign needs to be turned on again, it will be activated through mains electricity.
- 3. The product will automatically have monthly inspection. EXIT sign and indicator light will flash once every 30 or 31 days.
- 4. The product will automatically have an annual inspection. EXIT sign and indicator light will flash twice every year.

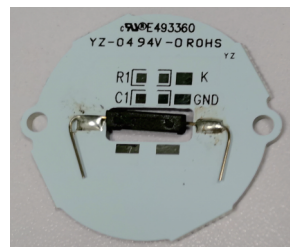

Image: Magnetic switch

Standard Materials:

- Housing: A356T6 aluminum with baked-on gray epoxy finish
- Gasket: One-piece silicone
- Hardware: Stainless steel
- Mounting Sling: Stainless steel
- EXIT Sign Plate: Tempered glass

J Series Explosion Proof Edge Lit LED Exit Sign

Model Encoding:

EX- * W J N * D180

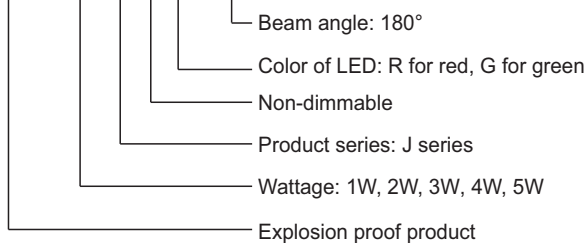

Dimension:

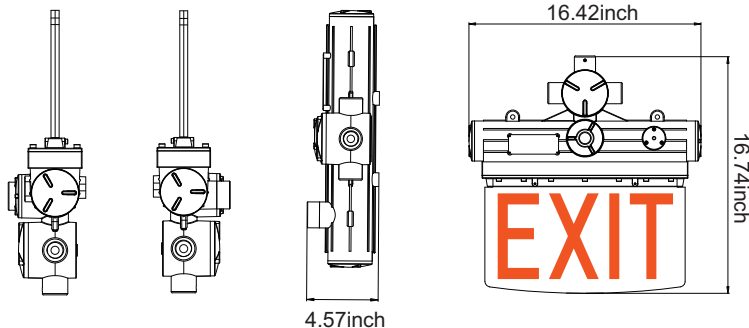

Mounting Methods and Accessories:

Wall Mounting:

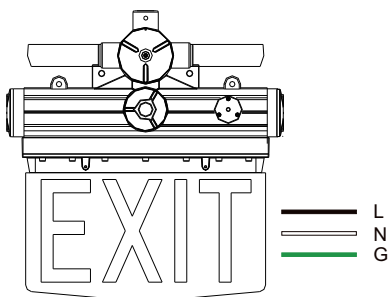

Pendant Mounting:

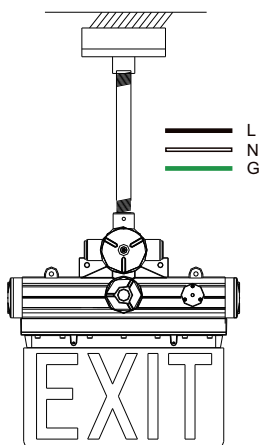

- Model: Ex-Straight Pipe
Name: Straight Pipe
Material: Iron



- Model: EX-HD51-KBI
Name: Junction Box
Material: Aircraft Aluminum A383

Pendant with Safe Wires:

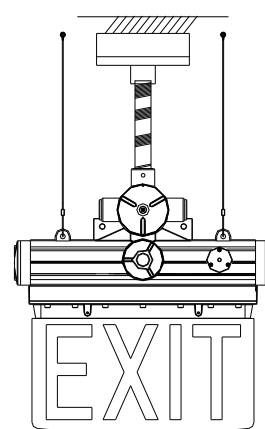

- Model: Ex-Straight Pipe
Name: Straight Pipe
Material: Iron



- Model: EX-HD51-KBI
Name: Junction Box
Material: Aircraft Aluminum A383



- Model: Ex-Straight Chain
Name: Pendant Chain
Material: Stainless Steel S30400



- Model: Ex-Hook
Name: Installation Hook
Material: Aircraft Aluminum A383

Packing Information:

Model	Quantity/Carton	Packing Size	Net Weight	Gross Weight
J Series	2 Pcs	18.50x18.50x10.24inch/470x470x260mm	6.0 kg/13.23 lbs	14.0 kg/30.86 lbs