



BPO LIGHTING
Hazardous Area Lighting

HAL HL



Class 1 Division 2 

Key Features

- FEATURES:** Round Low Bay Area Light
Extremely Rugged
Compact
High lm/W
BAA (Buy American Act)
- OPTIONS:** 2 Body Sizes (HL & HLL)
10 Mounting Styles
Military Grade Lens

Compliance

UL 844 Hazardous Locations
Class I Division 2 Groups A, B, C, D
Class I Zone 2 Group IIB
Class II Division 1 Groups E, F
Class II Division 2 Groups E, F
Class II Zone 20, 21, or 22 Group II B
Class III
UL 1598 Suitable for Wet Locations
UL 1598A Marine Saltwater
CSA C22.2 No. 250.0
CSA C22.2 No. 137
IP66
1Ex d IIC T5 @-40°C to +55°C (-40°F to +131°F)



(BAA) Fully compliant with the Buy American Act, meeting the requirements for domestic manufacturing and material sourcing as outlined in 41 U.S.C. §§

Applications

Oil and Gas

Petroleum production and refining
Petroleum loading, storage, transportation and retail
Confined spaces with vapor accumulation
LNG and LPG handling
Oil tankers and shipping vessels
Fuel system testing facilities

Power Plants

Coal-fired power plants, including coal handling and storage areas
Gas-fired power plants with fuel storage
Nuclear power facilities in hazardous auxiliary areas
Biomass or waste-to-energy plants with combustible dust risks

Industrial

Industrial storage facilities
Paper mills, sawmills and lumber yards
Loading dock platforms
Manufacturing plants for heavy industrial goods
Warehouses handling flammable materials

Waste Treatment

Wastewater treatment plants
Pumping stations
Solid waste processing and incineration facilities
Sewage treatment with methane gas risks
Hazardous waste recycling centers

Mining

Operations and service areas
Underground mining tunnels with gas accumulation

Chemical Industry

Chemical production, processing and storage facilities
Solvent handling and mixing areas
Chemical research labs with flammable substances

Ocean, Marine and Aerospace

Offshore platform operation facilities and structures
Marine and saltwater environments
Aerospace clean rooms and production areas
Ocean vessel operations
Shipyards and dry docks
Aircraft hangars with fuel vapors

Metal Treatment

Paint facilities
Steel and aluminum factories
Metal smelting, foundry and fabrication
Welding and cutting areas with gas risks

Military and Defense

Ammunition storage and handling
Fuel depots and refueling stations
Explosives manufacturing
Vehicle maintenance bays in hazardous zones

Food, Alcohol and Agriculture Industry

Flour and fine particle production and storage
Food and distilling production
Grain storage elevators and silos
Breweries and fermentation tanks
Feed mills with dust risks
Fertilizer production and storage

Pharmaceutical Industry

Drug manufacturing and solvent handling
Clean rooms with volatile compounds
Pill coating and drying areas
Research and development labs

Other high humidity, high dust, high temperature and vapor locations

Specifications

Wattage	36W	60W
OPTICAL		
Lumen Output	5200 lm (GM) 4900 lm (XPC)	8700 lm (GM) 8100 lm (XPC)
Lumens Per Watt	140 lm/W (GM) 135 lm/W (XPC)	135 lm/W (GM) 130 lm/W (XPC)
Color Temperature: CCT	5000K (standard), 3000-5000K options	
CRI (Color Rendering Index)	> 70	
Beam Angle	120°	
Light Source	Samsung LEDs / R1	
ENVIRONMENTAL		
Ambient Operating Temperature	-40°C to +55°C (-40°F to +131°F)	-40°C to +45°C (-40°F to +113°F)
Temperature Code	T5 (+55°C), T6 (+50°C)	T6 (+45°C)
MECHANICAL		
Housing Material	Copper free aluminum alloy	
Lens Diffuser	G: Borosilicate glass GM: Tempered borosilicate glass XPC: Extreme polycarbonate lens (Military lens)	
Hardware	Marine grade stainless steel	
Finish	Polyester powder coat finish	
Mounting	SB: Swivel Bracket PM: Pendant Mount SAB: Stanchion Mount 25° SSB: Stanchion Mount 90° WAB: Wall Mount 25° WMB: Wall Mount 90° CMB: Ceiling Mount EMB: Eye-Bolt Mount SBB: Swivel Bracket PMB: Pendant Mount	
Cable Entry	Classified for CID2 nickel plated brass adapter from M20 to 3/4" with 6' of wire	
Warranty	5 Year Standard Warranty	

ELECTRICAL

Lifespan	L70> 70,000 Operational Hours @ 25°C L70> 40,000 Operational Hours @ 55°C	L70> 100,000 Operational Hours @ 25°C L70> 50,000 Operational Hours @45°C
Input Frequency	50/60Hz	
Power Factor	> 0.95	
THD (Total Harmonic Distortion)	< 30%	<20%
LED Driver	Custom made 20-277VAC, 230-370VDC	MeanWell 90-295 VAC/127-417VDC
LED Driver Protection	Short circuit, over temperature, over voltage	Short circuit, over temperature,
Surge Protection	1kV	2kV
Inrush Current	27A	45A

Ordering Logic

ORDER EXAMPLE: HAL HL SB GM RV 120 5K 36W

(1) Product	(2) Product Category	(3) Mounting	(4) Lens
HAL	HL - Hazardous Location Rated Body (36W) HLL - Hazardous Location Rated Extra-Large Body (36/60W)	SB - Swivel Bracket (S) PM - Pendant Mount SAB - Stanchion Mount 25° SSB - Stanchion Mount 90° WAB - Wall Mount 25° WMB - Wall Mount 90° CMB - Ceiling Mount EMB - Eye-Bolt Mount SBB - B-type Swivel Bracket PMB - B-type Pendant Mount	G - Borosilicate Glass GM - Borosilicate Glass and Mesh Guard XPC - Extreme Polycarbonate Lens
(5) Voltage	(6) Optics	(7) Kelvin	(8) Wattage
RV - 120-277VAC	120 - 120°	3K - 3000 K 4K - 4000 K 5K - 5000 K(S)	36W (GM 5,200lm/XPC 4,900lm) 60W (GM 8,700lm/XPC 8,100lm)

(S) Standard

Accessories



CMB - Ceiling



SSB - Pedant



WAB - Pedant



PMB - Pedant



SAB - Pedant



PMB - Pedant



YMB - Pedant



WMB - Pedant

Product Dimensions

HAL-HL-SB 36W

Swivel Bracket

Fixture Weight: GM 8.16 lb [3.7 kg]

XPC 7.29 lb [3.3 kg]

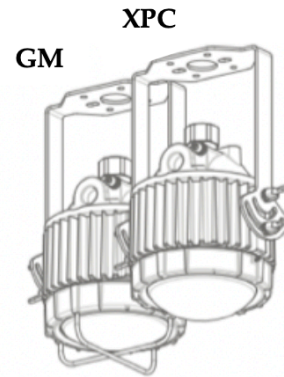
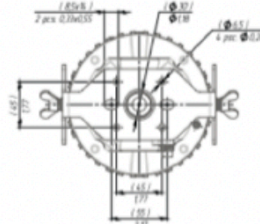
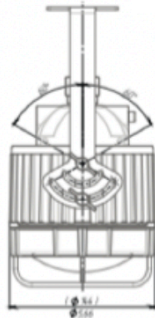
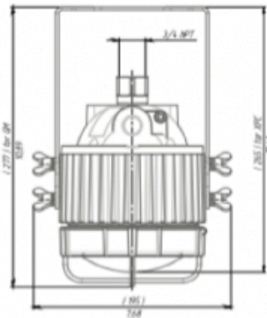

HAL-HL-SB 60W

Swivel Bracket

Fixture Weight: GM 12.15 lb [5.5 kg]

XPC 11.33 lb [5.1 kg]

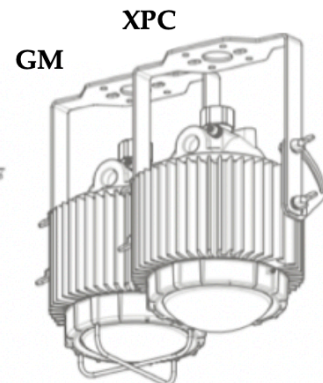
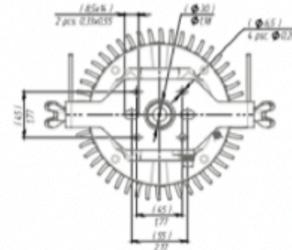
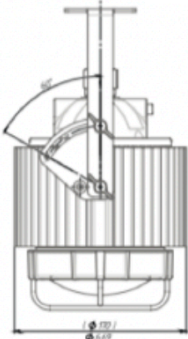
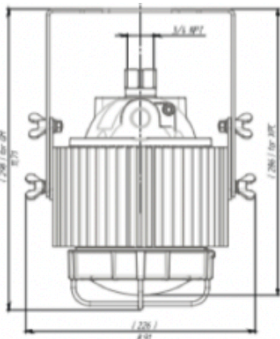

HAL-HL-PM 36W

Pendant Mount

Fixture Weight: GM 6.97 lb [3.2 kg]
XPC 6.17 lb [2.8 kg]

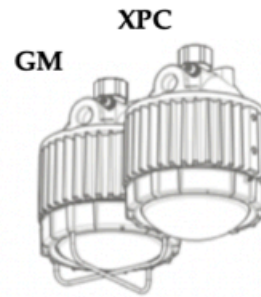
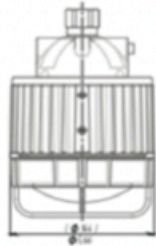
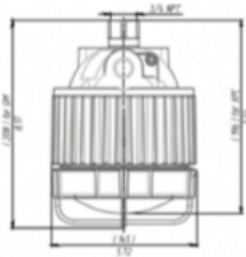

HAL-HL-PM 60W

Pendant Mount

Fixture Weight: GM 10.67 lb [4.9 kg]
XPC 9.85 lb [4.5 kg]

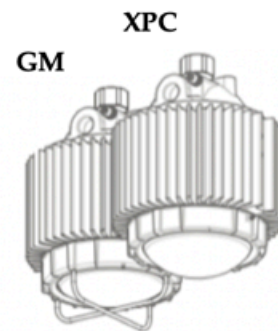
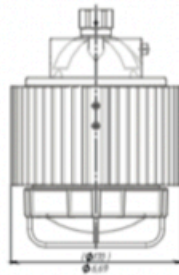
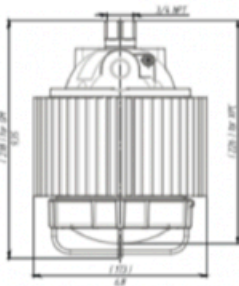

HAL-HL-SAB 36W

Stanchion Mount 25°

Fixture Weight: GM 9.90 lb [4.5 kg]
XPC 9.08 lb [4.1 kg]

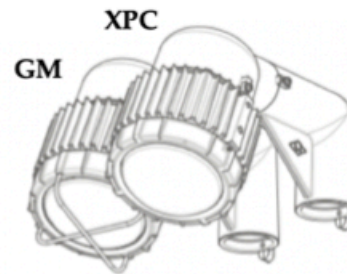
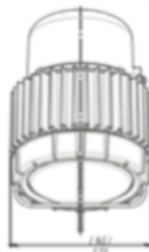
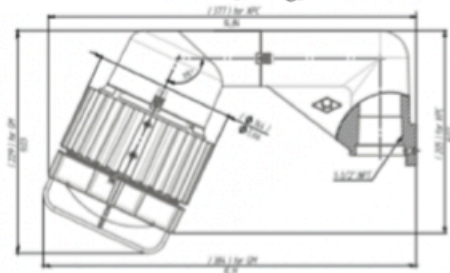

HAL-HL-SAB 60W

Stanchion Mount 25°

Fixture Weight: GM 13.60 lb [6.2 kg]

XPC 12.78 lb [5.8 kg]

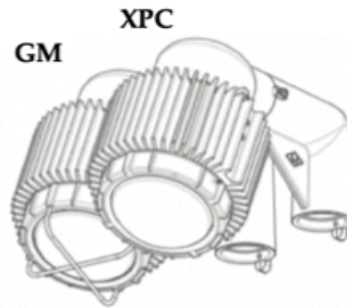
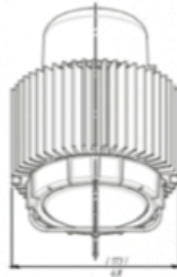
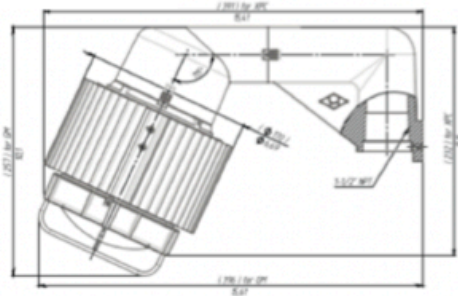

HAL-HL-SSB 36W

Stanchion Mount 90°

Fixture Weight: GM 10.41 lb [4.7 kg]

XPC 9.59 lb [4.4 kg]

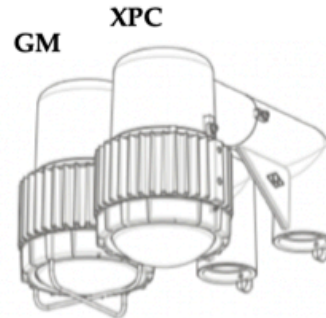
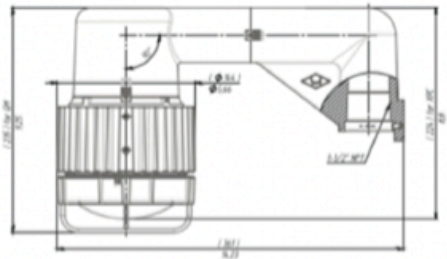

HAL-HL-SSB 60W

Stanchion Mount 90°

Fixture Weight: GM 14.11 lb [6.4 kg]

XPC 13.27 lb [6.0 kg]

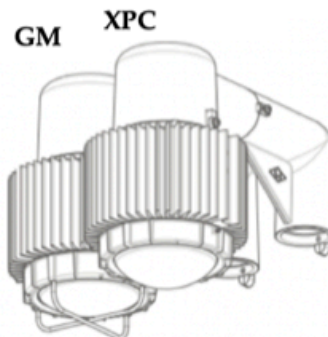
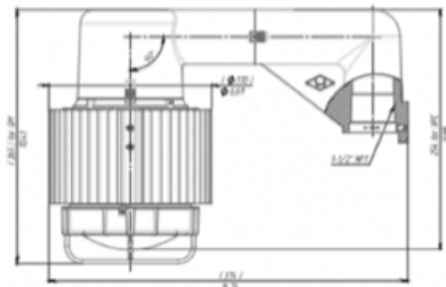

HAL-HL-WAB 36W

Wall Mount 25°

Fixture Weight: GM 11.68 lb [5.3 kg]

XPC 10.87 lb [4.9 kg]

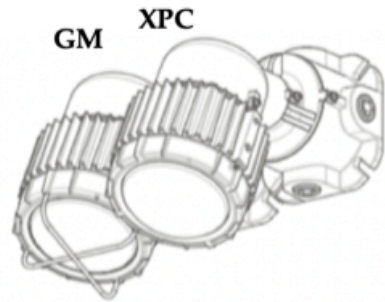
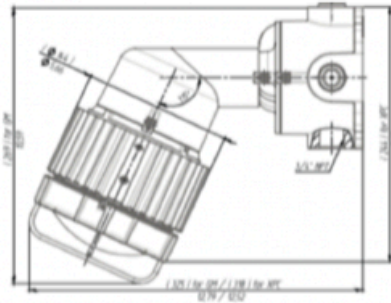
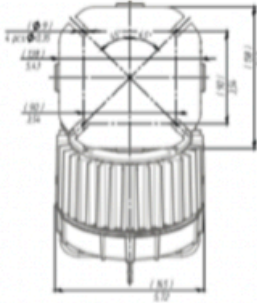

HAL-HL-WAB 60W

Wall Mount 25°

Fixture Weight: GM 15.37 lb [7.0 kg]

XPC 14.55 lb [6.6 kg]

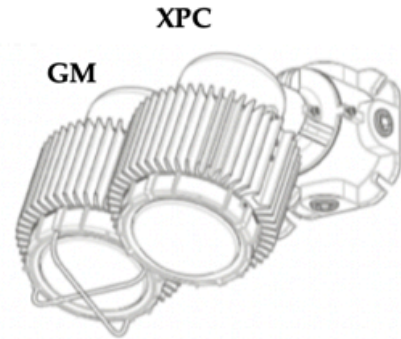
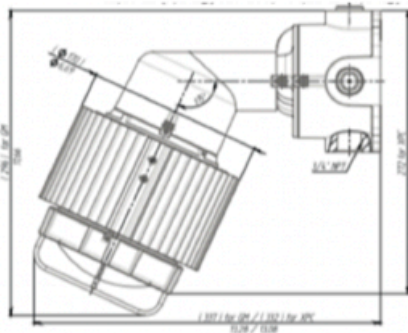
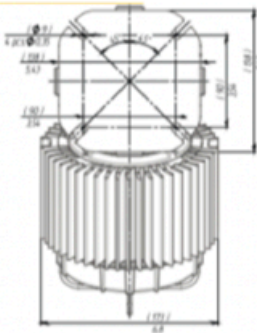

HAL-HL-WMB 36W

Wall Mount 90°

Fixture Weight: GM 12.17 lb [5.5 kg]

XPC 11.38 lb [5.2 kg]

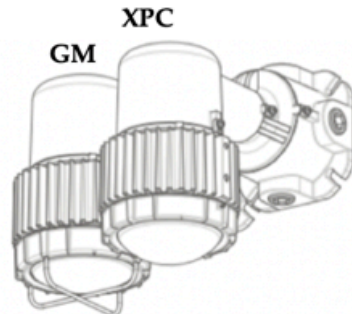
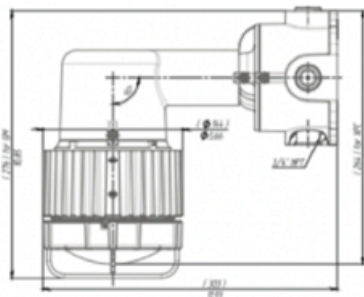
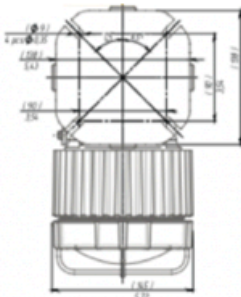

HAL-HL-WMB 60W

Wall Mount 90°

Fixture Weight: GM 15.87 lb [7.2 kg]

XPC 15.06 lb [6.8 kg]

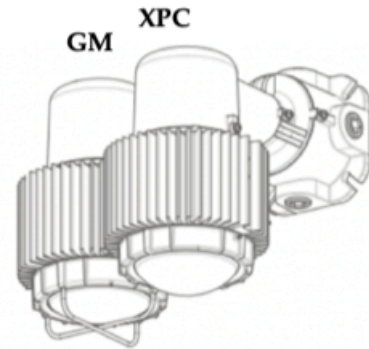
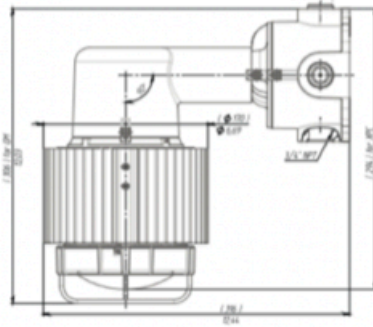
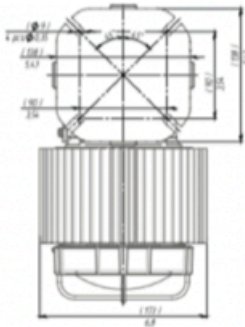

HAL-HL-CMB 36W

Ceiling Mount

Fixture Weight: GM 9.66 lb [4.4 kg]

XPC 8.84 lb [4.0 kg]

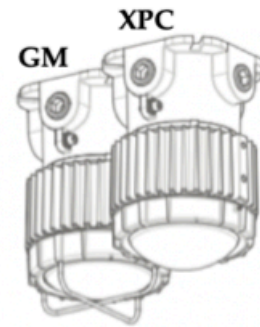
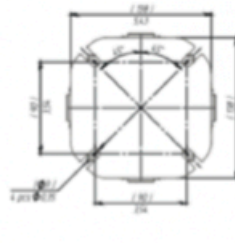
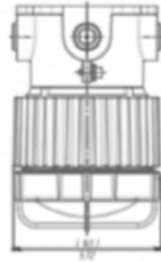
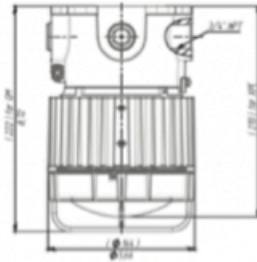

HAL-HL-CMB 60W

Ceiling Mount

Fixture Weight: GM 13.36 lb [6.1 kg]

XPC 12.54 lb [5.7 kg]

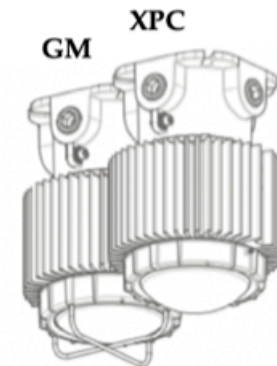
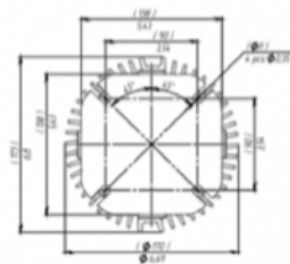
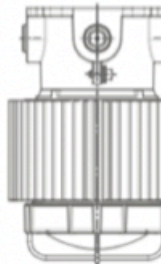
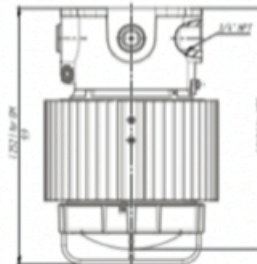

HAL-HL-EMB 36W

Eye-Bolt Mount

Fixture Weight: GM 8.71 lb [4.0 kg]

XPC 7.91 lb [3.6 kg]

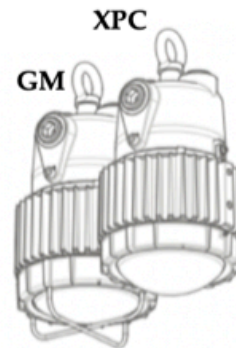
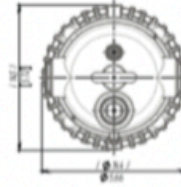
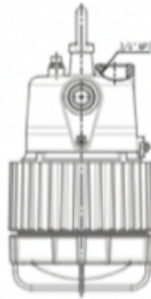
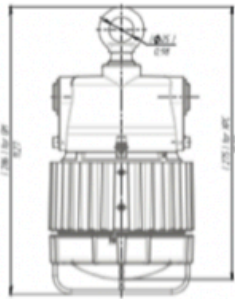

HAL-HL-EMB 60W

Eye-Bolt Mount

Fixture Weight: GM 12.41 lb [5.7 kg]

XPC 11.60 lb [5.3 kg]

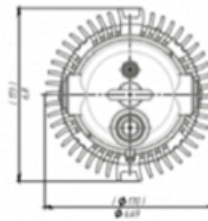
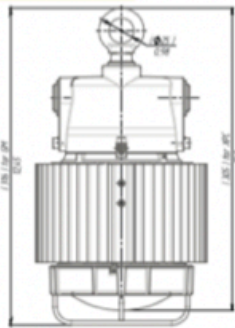

HAL-HL-SBB 36W

Swivel Bracket

Fixture Weight: GM 10.60 lb [4.8 kg]

XPC 9.79 lb [4.4 kg]

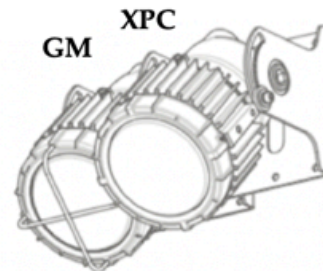
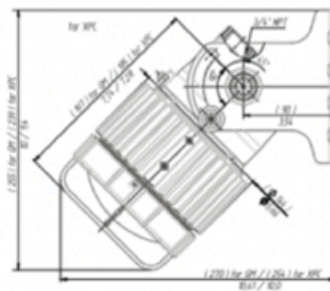
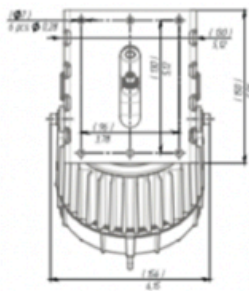

HAL-HL-SBB 60W

Swivel Bracket

Fixture Weight: GM 14.29 lb [6.5 kg]

XPC 13.49 lb [6.1 kg]

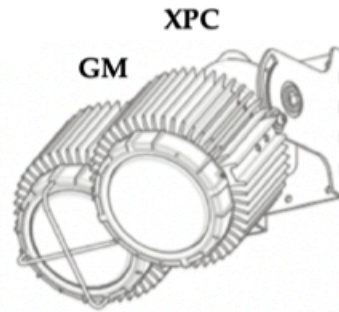
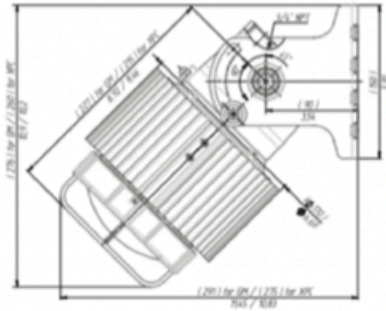
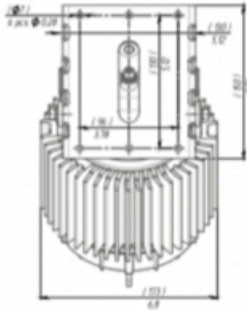

HAL-HL-PMB 36W

Pendant Mount

Fixture Weight: GM 8.28 lb [3.8 kg]

XPC 7.47 lb [3.4 kg]

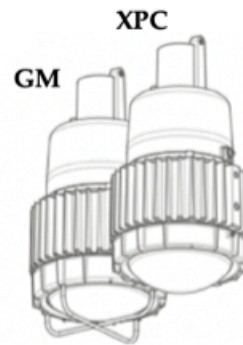
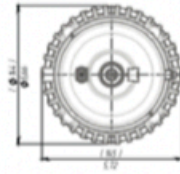
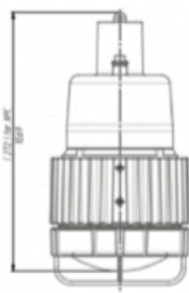
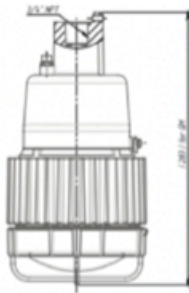

HAL-HL-PMB 60W

Pendant Mount

Fixture Weight: GM 11.97 lb [5.4 kg]

XPC 11.15 lb [5.0 kg]

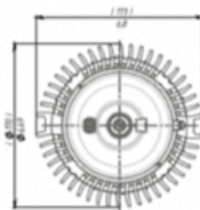
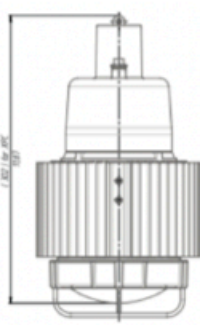
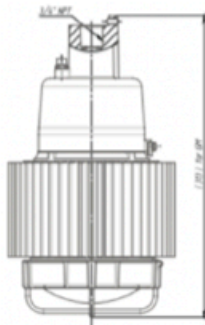

Packaging Information

	36W		60W	
	GM	XPC	GM	XPC
Pieces	1		1	
Fixture Dimensions	See Product Dimensions Drawing		See Product Dimensions Drawing	
Net Fixture Weight	6.97 LBS (3.2 KG) Swivel Bracket 8.16 lb (3.7 kg) Pendant Mount 6.97 lb (3.2 kg) Stanchion Mount 25° 9.90 lb (4.5 kg) Stanchion Mount 90° 10.41 lb (4.7 kg) Wall Mount 25° 11.68 lb (5.3 kg) Wall Mount 90° 12.17 lb (5.5 kg) Ceiling Mount 9.66 lb (4.4 kg) Eye-Bolt Mount 8.71 lb (4.0 kg) Swivel Bracket 10.60 lb (4.8 kg) Pendant Mount 8.28 lb (3.8 kg)	6.17 LBS (2.8 KG) Swivel Bracket 7.29 lb (3.3 kg) Pendant Mount 6.17 lb (2.8 kg) Stanchion Mount 25° 9.08 lb (4.1 kg) Stanchion Mount 90° 9.59 lb (4.4 kg) Wall Mount 25° 10.87 lb (4.9 kg) Wall Mount 90° 11.38 lb (5.2 kg) Ceiling Mount 8.84 lb (4.0 kg) Eye-Bolt Mount 7.91 lb (3.6 kg) Swivel Bracket 9.79 lb (4.4 kg) Pendant Mount 7.47 lb (3.4 kg)	10.67 LBS (4.9 KG) Swivel Bracket 12.15 lb (5.5 kg) Pendant Mount 10.67 lb (4.9 kg) Stanchion Mount 25° 13.60 lb (6.2 kg) Stanchion Mount 90° 14.11 lb (6.4 kg) Wall Mount 25° 15.37 lb (7.0 kg) Wall Mount 90° 15.87 lb (7.2 kg) Ceiling Mount 13.36 lb (6.1 kg) Eye-Bolt Mount 12.41 lb (5.7 kg) Swivel Bracket 14.29 lb (6.5 kg) Pendant Mount 11.97 lb (5.4 kg)	9.85 LBS (4.5 KG) Swivel Bracket 11.33 lb (5.1 kg) Pendant Mount 9.85 lb (4.5 kg) Stanchion Mount 25° 12.78 lb (5.8 kg) Stanchion Mount 90° 13.27 lb (6.0 kg) Wall Mount 25° 14.55 lb (6.6 kg) Wall Mount 90° 15.06 lb (6.8 kg) Ceiling Mount 12.54 lb (5.7 kg) Eye-Bolt Mount 11.60 lb (5.63 kg) Swivel Bracket 13.49 lb (6.1 kg) Pendant Mount 11.15 lb (5.0 kg)