

D

D2



Class 1 Division 1

Key Features

- FEATURES:** Rectangular Low-Bay/High-Bay Area Light (Rugged)
High lm/W
- OPTIONS:** 2 Body Sizes
7 Mounting Styles
Impact Resistant
High Voltage
40°, 60°, 90° or 120°
Emergency Back-Up

Compliance

UL 844 Hazardous Locations
Class I Division 1 Groups C, D
Class I Division 2 Groups A, B, C, D
Class I Zone 1 Group IIB
Class II Division 1 Groups E, F, G
Class II Division 2 Groups F, G
Class II Zone 21 Group IIIC
Class III
UL 1598 Suitable for Wet Locations
UL 1598A Marine Saltwater
UL 924 Emergency Lighting

CSA C22.2 No. 250.0:2021 Ed.5
CSA C22.2 No. 137: 2018 Ed.2
IP66
IP67
IK08 (Glass Cover)
IK10 (With Wire Guard)
1000 Hours Salt Spray
ETL (ATM for Report 105342415DAL-001/003)
ABS
CB (Ref. Certif. No.: DE 2-028898)
DLC select versions

Applications

Oil and Gas

Petroleum production and refining
Petroleum loading, storage, transportation and retail
Confined spaces with vapor accumulation
LNG and LPG handling
Oil tankers and shipping vessels
Fuel system testing facilities

Power Plants

Coal-fired power plants, including coal handling and storage areas
Gas-fired power plants with fuel storage
Nuclear power facilities in hazardous auxiliary areas
Biomass or waste-to-energy plants with combustible dust risks

Industrial

Industrial storage facilities
Paper mills, sawmills and lumber yards
Loading dock platforms
Manufacturing plants for heavy industrial goods
Warehouses handling flammable materials

Waste Treatment

Wastewater treatment plants
Pumping stations
Solid waste processing and incineration facilities
Sewage treatment with methane gas risks
Hazardous waste recycling centers

Mining

Operations and service areas
Underground mining tunnels with gas accumulation

Chemical Industry

Chemical production, processing and storage facilities
Solvent handling and mixing areas
Chemical research labs with flammable substances

Ocean, Marine and Aerospace

Offshore platform operation facilities and structures
Marine and saltwater environments
Aerospace clean rooms and production areas
Ocean vessel operations
Shipyards and dry docks
Aircraft hangars with fuel vapors

Metal Treatment

Paint facilities
Steel and aluminum factories
Metal smelting, foundry and fabrication
Welding and cutting areas with gas risks

Military and Defense

Ammunition storage and handling
Fuel depots and refueling stations
Explosives manufacturing
Vehicle maintenance bays in hazardous zones

Food, Alcohol and Agriculture Industry

Flour and fine particle production and storage
Food and distilling production
Grain storage elevators and silos
Breweries and fermentation tanks
Feed mills with dust risks
Fertilizer production and storage

Pharmaceutical Industry

Drug manufacturing and solvent handling
Clean rooms with volatile compounds
Pill coating and drying areas
Research and development labs

Other high humidity, high dust, high temperature and vapor locations

Specifications

Wattage	20W	40W	60W	80W	100W	150W	200W	220W
Body	D2				D			

OPTICAL

Lumen Output	2720 lm	5600 lm	8400 lm	11200 lm	14000 lm	21000 lm	28000 lm	28600 lm
Lumens Per Watt	136 lm/W	140 lm/W						130 lm/W
Color Temperature: CCT	Standard: 5000K Options: 2700K - 7000K							
CRI (Color Rendering Index)	>70							
Beam Angle	120° Standard 40°, 60°, 90°option							
Dimming	0-10V dimming							

ENVIRONMENTAL

Ambient Operating Temperature	T4: -40°C to 55°C (-40°F to 131°F).	T4: -40°C to 45°C (-40°F to 113°F)
Temperature Code	T4: (+55°C)	T4: (+45°C)

MECHANICAL

Housing Material	Copper-free aluminum	
Lens Diffuser	Tempered glass	
Hardware	Stainless steel	
Mounting	Ceiling, Wall, Pole	Ceiling
Cable Entry	Top: 3/4" NPT; Side: 3/4" NPT	Side: 3/4" NPT
Warranty	5-Year Standard Warranty	

ELECTRICAL

Lifespan	L70> 150,000 Operational Hours @ 55°C
Input Voltage	100-277VAC, 200-480VAC, 12-48VDC
Input Frequency	50/60Hz
Power Factor	> 0.95

EMERGENCY

Emergency Time	3 Hour Optional
----------------	-----------------

Ordering Logic

ORDER EXAMPLE: HLL D EX 80W D2 D 50 D120

(1) Product	(2) Product Category	(3) Wattage	(4) Shape Series	(5) Dimming	(6) Kelvin
HLL D	EX - Explosion Proof	20W (2,800 lm)	D2 - 20/40/60/80W	D - Dimmable	30 - 3000 K
		40W (5,600 lm)	D 100/150/200/220W	N - Non-Dimmable	40 - 4000 K
		60W (8,400 lm)			50 - 5000 K (S)
		80W (11,200 lm)			
		100W (14,000 lm)			
		150W (21,000 lm)			
		200W (28,000 lm)			
220W (28,600 lm)					
(7) Beam Angle	(8) Diffuser Type	(9) Voltage	(10) Backup Power Source		
D40 - 40°	Blank - Flat Glass (S)	Blank - 100-277 (S)	Blank - Without Emergency Function (S)		
D60 - 60°	C - Spherical Glass Cover	HV - 200-480 (+80W)	EM - Emergency Back Up (D3)		
D90 - 90°					
D120 - 120° (S)					

(S) Standard

Accessories



Junction Box



Straight Pipe



Bended Pipe



Chain



Bracket



Metal Conduit

Light Distribution

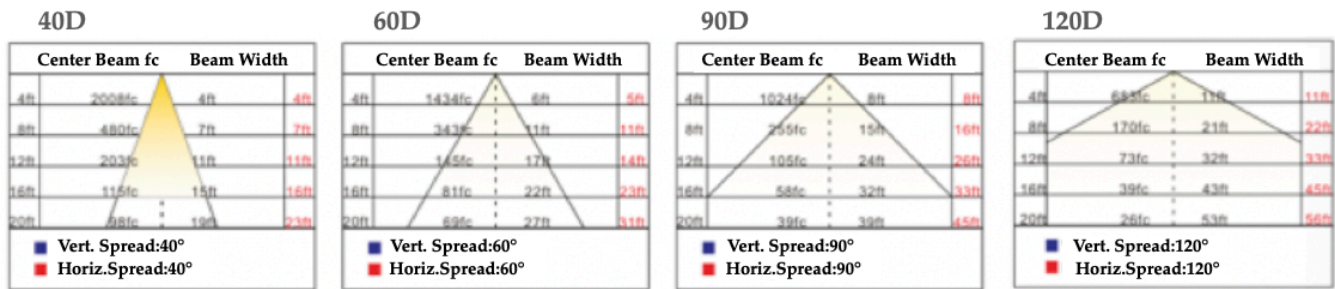

Photometric

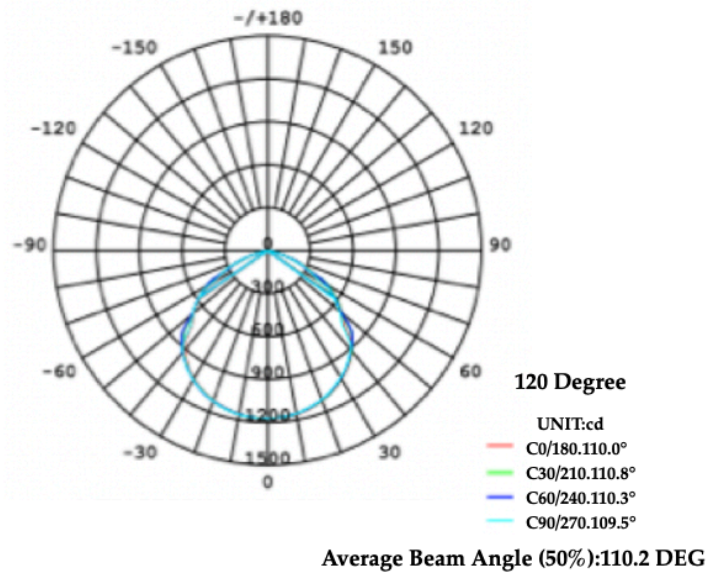
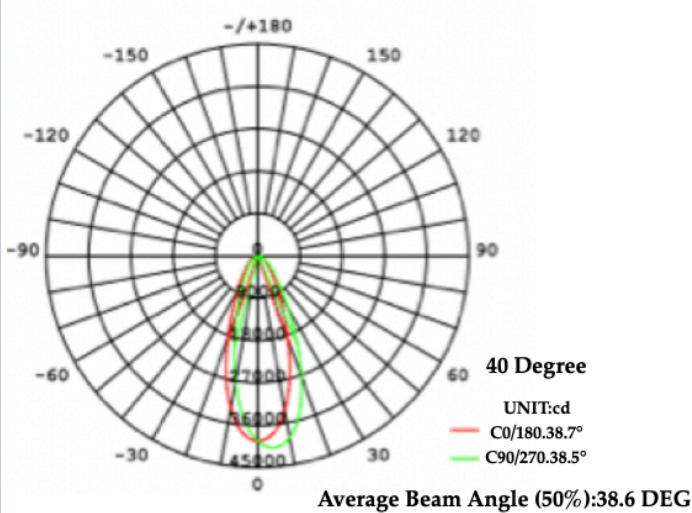

Product Dimensions

D2

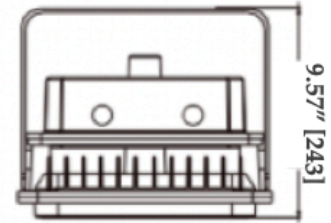
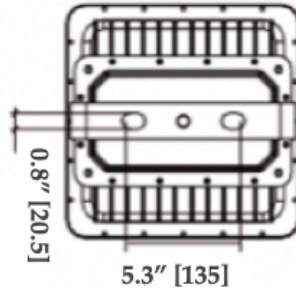
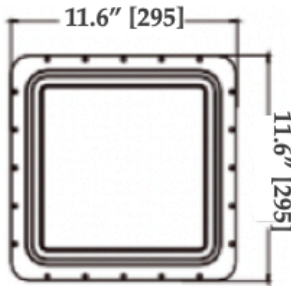

D

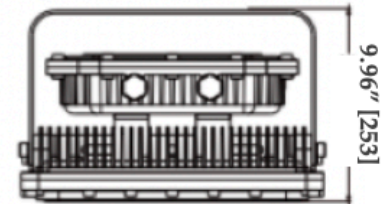
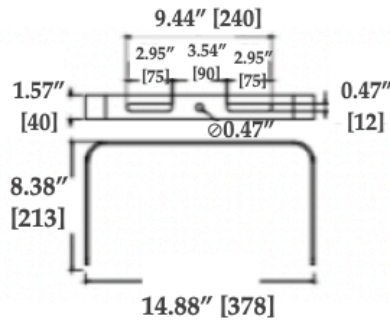
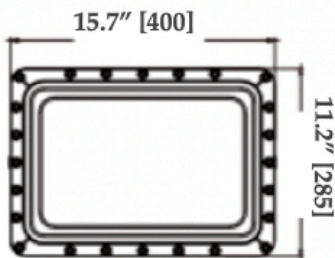

Packaging Information

	D2	D
Fixture Dimensions	See Product Dimensions Drawing	See Product Dimensions Drawing
Package Dimensions	15.75" x 15.16" x 13.19" (400mm x 385mm x 335mm)	19.76" x 14.8" x 13.78" (502mm x 376mm x 350mm)
Net Fixture Weight	7 kg/ 15.43 lb	17.9 kg/ 39.46 lb
Gross Weight	9.5 kg/ 20.94 lb	19.5 kg/ 42.99 lb

Mounting Methods

Option 1: Ceiling Mounting (For D2)

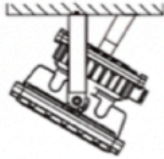

Accessory



Bracket

Option 2: Wall Mounting (For D2)

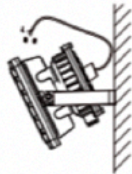

Accessory



Bracket

Option 3: Poll Mounting (Vertical) (For D2)



Accessory



Junction-Box



Straight Pipe

Option 4: Poll Mounting (Non-Vertical) (For D2).

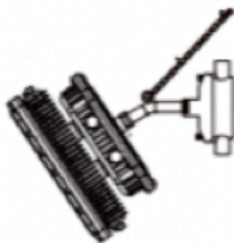

Accessory



Junction-Box



Bended Pipe



Straight Chain

Option 5: Poll Mounting (For D2)

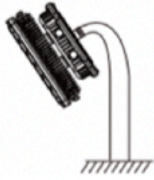

Option 6: Trunnion Mounting (For D2)



Accessory



Slip Fitter Mounting Kit

Option 7: Ceiling Mounting (For D2)

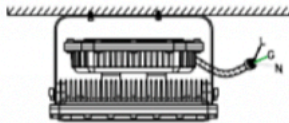

Accessory



Bracket