

University of Turkish Aeronautical
Association
Department of Electrical & Electronic Engineering

Graduation project report

In partial fulfillment of the requirements for the degree of Master of Science
without thesis
In electrical & electronic engineering

TESTING OF OPTICAL FIBER CABLE

By
Abdulgader h. Abdulgader ALSHARIF

Supervisor :
Dr. Hasaan SHARABATY

December2015

Abstract

The main idea of this work is to give an overview about testing of fiber-optic cable. The most important device for testing fiber optic cable is Optical Time Domain Reflect meter (OTDR) Testing. The most important devices for optical fiber transmission systems are presented, and their properties discussed. In particular we consider such systems working with those basic components which are necessary to explain the principle of its operations.

In the focus of the considerations we will find the optical fiber as the dominant element in optical communication systems. Different fiber types are presented, and their properties explained with different kinds of processing and an experiment

The systems operate as transmission links with bit rates up to 40 Gbit/s and more. Furthermore optical communication systems are also used for recent application areas in the MBit/s region, e.g. in aviation, automobile and maritime industry.

Abdulgader ALSHARIF

M.S. Electrical & Electronic.

Graduation Project Supervisor: Dr. Hassan SHARABATY

December 2015, 39 pages

Keywords: Testing of optical fiber cable.

ACKNOWLEDGMENTS

This work is made possible through the help and support from everyone, including: parents, teachers, family, friends, and in essence, all sentient beings.

Especially, please allow me to dedicate my acknowledgment of gratitude toward the following significant advisors and contributors:

First and foremost, I would like to thank Dr. Hassan SHARBATY for his most support and encouragement. He kindly read my term project and offered invaluable detailed advices on grammar, organization, and the theme of the term project.

Second, I would like to thank as well as all the other doctors who have taught me over the past two years of my master degree.

Finally, I sincerely thank my parents, family, and friends, who provide the advice and financial support. The product of this research would not be possible without all of them, our praise to Allah.

TABEL OF CONTENTS

ABSTRACT	ii
ACKNOWLEDGMENTS	iv
TABLE OF CONTENTS.....	vi
TABLE OF FIGURES.....	viii
1 GENERAL INTRODUCTOIN OF OPTICAL FIBER	x

CHAPTER 1

Introduction to OPTICAL FIBRES

1-1 What is fiber optics?	1
1-2 Who invented fiber optics?	2
1-3 Total internal reflection.....	3
1-4 Fiber Optics Fundamentals	5
1-5 Optical fiber cables	6
1-6 The Design of Fiber Core and Cladding	8
1-7 Types of fiber Optic	9
1-7-1 Step-index Multimode	9
1-7-2 Step index	10
1-7-3 Graded-index	10
1-8 Optical Fiber Sizes	11
1-9 Advantages	11
1-10 Disadvantages	12
1-11 EXPERMENT	12
1-12 Uses of Fiber Optic Cables	14
1-12-1 Military	16
1-12-2 Transportation	17
1-12-3 UAVs & Drones	18

Chapter 2

Desecration for OVD

2-1 Introduction to OVD.....	20
------------------------------	----

2-2 kinds of processing in optical fiber	20
2-2-1 From Theory to Practical Application	22
2-2-2 How Fiber Works	21
2-3 Outside Vapor Deposition (OVD) Process	23
2-3-1 Laydown.....	23
2-3-2 Consolidation	24
2-3-3 The Draw	25
2-3-4 OVD Benefits	25

Chapter 3

Testing of optical fiber cable

3-1 Introduction	26
3-2 Types Of Tests	26
3-2-1 "Flashlight" Test	26
3-2-2 Attenuation (Loss) Test	27
3-2-3 Optical Time Domain Reflectometer Test.....	31
3-3 OTDR description for the device.....	32
3-4 Testing Loss with Optical Power Mete.....	34
3-5 Description of the testing device.....	34
4 Conclusion.....	35
5 References	36
Curriculum vitae	39

Table of figures

Chapter 1

Figure (1) Optical fiber cable	1
Figure (2) Total internal reflection.....	3
Figure (3) Fiber optic cable.....	4
Figure 4 the electric interact charge.....	5
Figure (5) Total internal reflection in Optical fiber cable.....	6
Figure (6) Medium for carrying info.	6
Figure (7) Components of optical fiber cable.....	9
Figure (8) diagram of optical fiber cable types.....	9
Figure (9) for size of optical fiber	11
Figure (10) Photo showing fiber optic bottle and torch.....	13
Figure (11) experimented with transmitting voice signals.....	15
Figure (12) for Traverse Earth's Oceans cable.....	16
Figure (13) for Yup & drones.....	18
Figure (14) lighting for Christmas trees using fiber.....	19
Figure (15) Decoration, Fiber Optic lighting	19

Chapter 2

Figure (1) for Laydown FOR (OVD)	23
Figure (2) Consolidation step.....	24
Figure (3) for Draw tower.....	25

Chapter 3

Figure (1) of optical power meter with flashlight	27
Figure (2) Attenuation Test Without Auto-Zero	29
Figure (3) Attenuation Test with Auto-Zero.....	30
Figure (4) of Optical Time Domain Reflectometer.....	31
Figure (5) Sample OTDR Display.....	32
Figure (6) C880 Certification Optical Loss Test Kit.....	35

1 GENERAL INTRODUCTION

Fiber optics is a major of building block in the telecommunication infrastructure. Its high bandwidth capabilities and low attenuation characteristics make it ideal for gigabit transmission and beyond.

In this work, we will be introduced the testing of optical fiber cable with the different methods of testing the cable as the title has mentioned. Therefore, the building blocks that makes up a fiber optic communication system. We will talk about the different types of fiber and their applications, light sources, how to test the cable using three methods and detectors.

Chapter one is presented the description of the main characteristics of the optical fibers and the principle of work, the difference between multimode, single-mode and graded index, the experiment for the optical fiber operation, total internal reflection operation, types of the optical fiber cable and fundamental for the same topic.

Chapter two presented an introduction for an OVD in optical fiber, how do they work, from what is elements do they have made and the Basic OVD optical fiber manufacturing consists of three steps (laydown, consolidation, and draw).

Chapter three is the last one and presented testing of optical fiber cable, its types with the machine for measuring the cable called the (optical power meter). They are commonly used to measure absolute light power in dBm. For dBm measurement of light transmission power, proper calibration is essential.

A fiber optic power meter is also used with an [optical light source](#) for measuring loss or relative power level in dB.

The use of light to send messages is not new. Fires were used for signaling in biblical times, smoke signals have been used for thousands of years and flashing lights have been used to

communicate between warships at sea since the days of Lord Nelson.

The idea of using glass fiber is to carry an optical communications signal originated with Alexander Graham Bell. However this idea had to wait some 80 years for better glasses and low-cost electronics for it to become useful in practical situations.

Chapter 1

Optical fiber

1-1 What is fiber optics?

Fiber-optic communications are based on the principle that light in a glass medium can carry more information over longer distances than electrical signals can carry in a copper or coaxial medium or radio frequencies through a wireless medium. The purity of today's glass fiber, combined with improved system electronics, enables fiber to transmit digitized light signals hundreds of kilometers without amplification as shown in figure 1 below. With few transmission losses, low interference, and high bandwidth potential, optical fiber is an almost ideal transmission medium [1].

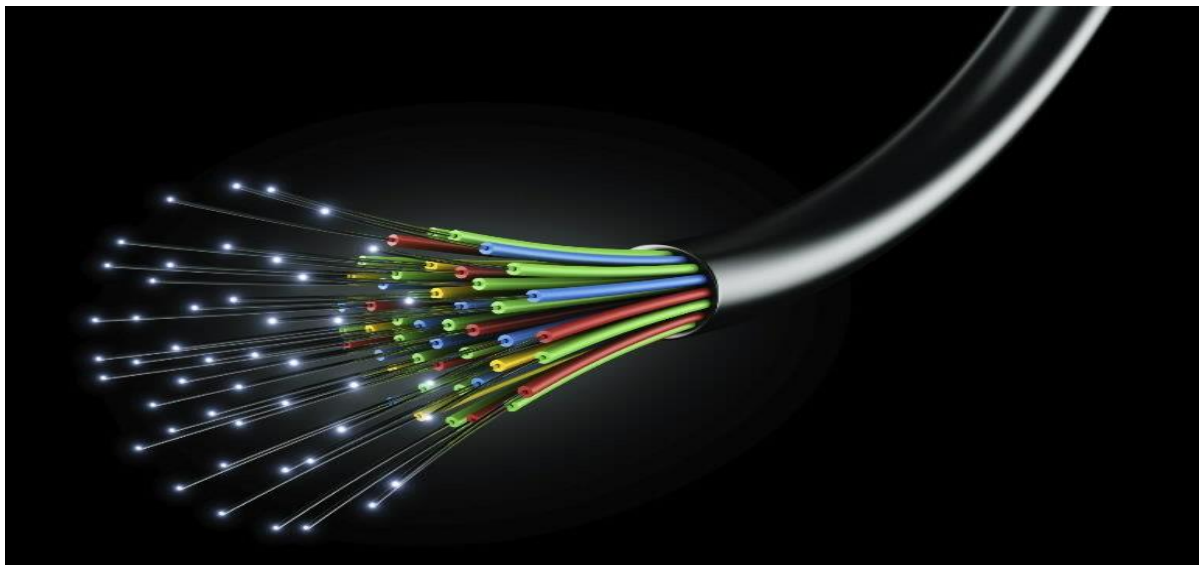

Figure (1) Optical fiber cable

We are used to the idea of information traveling in different ways. When we speak into a landline telephone, a wire cable carries the sounds from our voice into a socket in the wall, where another cable takes it to the local telephone exchange, later we will introduce the idea with a picture describe the operation.

Cellphones work a different way: they send and receive information using invisible radio waves—a technology called wireless because it uses no cables.

Fiber optics works a third way. It sends information coded in a beam of light down a glass or plastic pipe. It was originally developed for endoscopes in the 1950s to help doctors see inside the human body without having to cut it open first. In the 1960s, engineers found a way of using the same technology to transmit telephone calls at the speed of light (186,000 miles or 300,000 km per second) [2].

1-2 Who invented fiber optics?

1840s: Swiss physicist Daniel Collation (1802–1893) discovered, he could shine light along a water pipe. The water carried the light by internal reflection.

In 1870: An Irish physicist called John Tyndall (1820–1893) demonstrated internal reflection at London's Royal Society. He shone light into a jug of water. When he poured some of the water out from the jug, the light curved round following the water's path. This idea of "bending light" is exactly what happens in fiber optics. Although Colladon is the true grandfather of fiber-optics, Tyndall often earns the credit.

1930s: Heinrich Lamm and Walter Gerlach, two German students, tried to use light pipes to make a gastro scope—an instrument for looking inside someone's stomach.

1950s: In London, England, Indian physicist Narinder Kapany (1927) and British physicist Harold Hopkins (1918–1994) managed to send a simple picture down a light pipe made from thousands of glass fibers. After publishing many scientific papers, Kapany earned a reputation as the "father of fiber optics".

1957: Three American scientists at the University of Michigan, Lawrence Curtiss, Basil Hirschowitz, and Wilbur Peters, successfully used fiber-optic technology to make the world's first gastro scope.

1960s: Chinese-born US physicist Charles Kao (1933) and his colleague George Hockham realized that impure glass was no use for long-range fiber optics. Kao suggested that a fiber-optic cable made from very pure glass would be able to carry telephone signals over much longer distances and was awarded the 2009 Nobel Prize in Physics for this ground-breaking discovery.

1960s: Researchers at the Corning Glass Company made the first fiber-optic cable capable of carrying telephone signals.

1977: The first fiber-optic telephone cable was laid between Long Beach and Artesia, California.

1997: A huge transatlantic fiber-optic telephone cable called FLAG (Fiber-optic Link around the Globe) was laid between London, England and Tokyo, Japan [2].

1-3 Total internal reflection

An effect that combines both refraction and reflection is total internal reflection. Consider light coming from a dense medium like water into a less dense medium like air as shown down in figure 2.

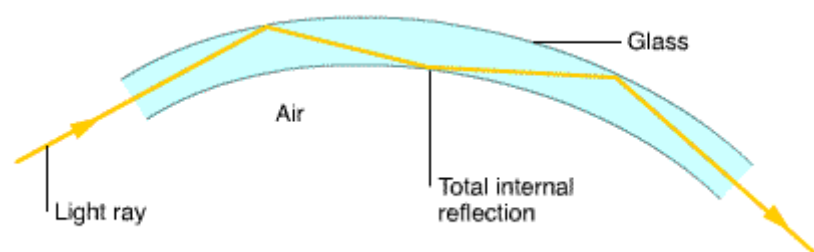

Figure (2) Total internal reflection

When the light coming from the water strikes the surface, part will be reflected and part will be refracted. Measured with respect to the normal line perpendicular to the surface, the reflected light comes off at an angle equal to that at which it entered at, while that for the refracted light is larger than the incident angle.

In fact, the greater the incident angle, the more the refracted light bends away from the normal. Thus, increasing the angle of incidence from path ``1" to ``2" will eventually reach a point where the refracted angle is 90° , at which point the light appears to emerge along the surface between the water and air. If the angle of incidence is increased further, the refracted light cannot leave the water. It gets completely reflected.

The interesting thing about total internal reflection is that it really is total. That is 100% of the light gets reflected back into the more dense medium, as long as the angle at which it is incident to the surface is large enough as shown in figure 3 [3].

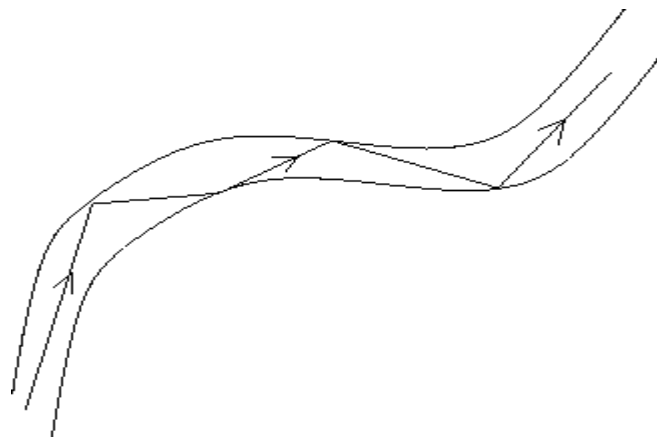

Figure (3) Fiber optic cable

The light enters the glass cable, and as long as the bending is not too sudden, will be totally internally reflected when it hits the sides, and thus is guided along the cable. This is used in telephone and cable TV cables to carry the signals. Light as an information carrier

is much faster and more efficient than electrons in an electric current.

Also, since light rays don't interact with each other (whereas electrons interact via their electric charge) as shown below in figure 4 for the interact in electric charge, but for the fiber optic as shown in figure 3, it is possible to pack a large number of different light signals into the same fiber optics cable without distortion. You are probably most familiar with fiber optics cables in novelty items consisting of thin, multi-colored strands of glass which carry light beams [4].

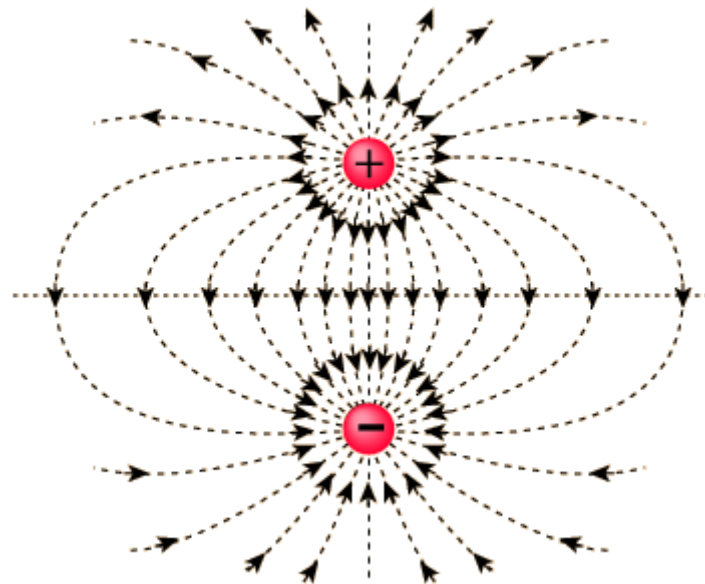

Figure 4 the electric interact charge

1-4 Fiber Optics Fundamentals

The science of fiber optics deals with the transmission or guidance of light (rays or waveguide modes in the optical region of the spectrum) along transparent fibers of glass, plastic, or a similar medium. The phenomenon responsible for the fiber or light-pipe performance is the law of total internal reflection as shown below in figure 5 [3].

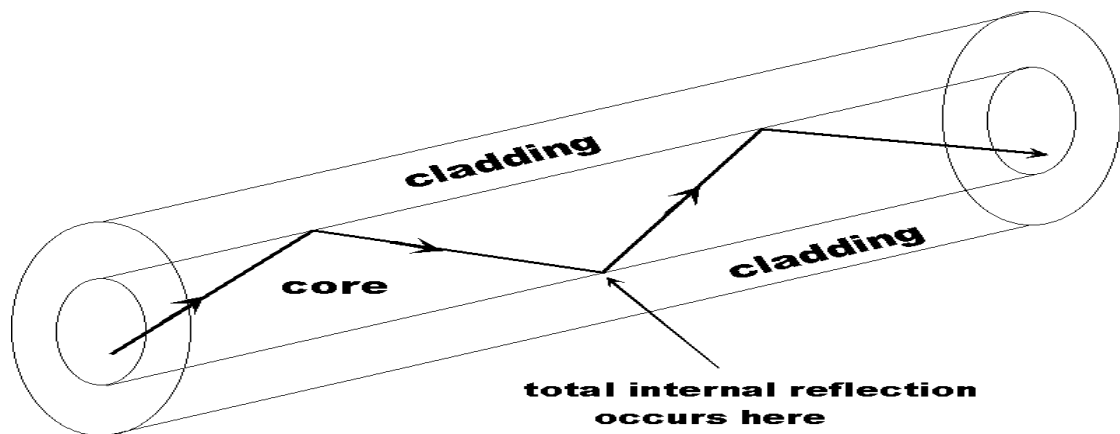

Figure (5) Total internal reflection in Optical fiber cable.

Fiber optics is a medium for carrying information from one point to another in the form of light, the block diagram below explain the medium for carrying information in figure 6. Unlike the copper form of transmission, fiber optics is not electrical in nature.

A basic fiber optic system consists of some devices as shown in the diagram below, a transmitting device that converts an electrical signal into a light signal, an optical fiber cable that carries the light, and a receiver that accepts the light signal and converts it back into an electrical signal [2].

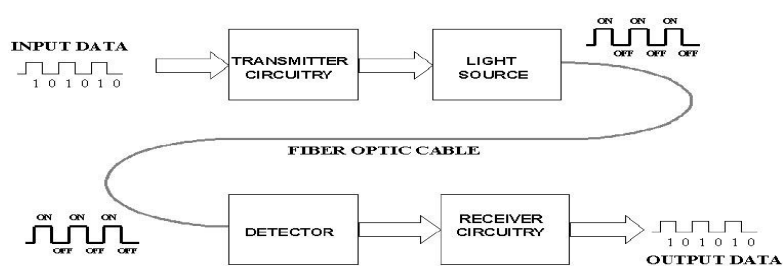

Figure (6) Medium for carrying info.

1-5 Optical fiber cables

An optical fiber cable is a cable containing one or more optical fibers. The optical fiber elements are typically individually coated with plastic layers and contained in a protective tube suitable for the environment where the cable will be deployed [4].



Optical fibers are alternatives to electrical transmission lines it is imperative that they can be safely installed and maintained in all the environments (e.g. underground ducts) in which metallic conductors are normally placed.

Therefore, when optical fibers are to be installed in a working environment their mechanical properties are of prime importance. In this respect the unprotected optical fiber has several disadvantages with regard to its strength and durability.

Bare glass fibers are brittle and have small cross-sectional areas which make them very susceptible to damage when employing normal transmission line handling procedures. Therefore, it is necessary to cover the fibers to improve their tensile strength and to protect them against external influences. This is usually achieved by surrounding the fiber with a series of protective layers, which is referred to as coating and cabling.

The initial coating of plastic with high elastic modulus is applied directly to the fiber cladding. It is then necessary to incorporate the coated and buffered fiber into an optical cable to increase its resistance to mechanical strain and stress as well as adverse environmental conditions.

The functions of the optical cable may be summarized into four main areas. These are as follows:

1. Fiber protection. The major function of the optical cable is to protect against fiber damage and breakage both during installation and throughout the life of the fiber.

2. Stability of the fiber transmission characteristics. The cabled fiber must have good stable transmission characteristics which are comparable with the uncabled fiber. Increases in optical attenuation due to cabling are quite usual and must be minimized within the cable design.

3. Cable strength. Optical cables must have similar mechanical properties to electrical transmission cables in order that they may be handled in the same manner. These mechanical properties include tension, torsion, compression, bending, squeezing and vibration. Hence the cable strength may be improved by incorporating a suitable strength member and by giving the cable a properly designed thick outer sheath.

4. Identification and jointing of the fibers within the cable. This is especially important for cables including a large number of optical fibers. If the fibers are arranged in a suitable geometry it may be possible to use multiple jointing techniques rather than jointing each fiber individually [5].

1-6 The Design of Fiber Core and Cladding

An optical fiber consists of two different types of highly pure, solid glass, composed to form the core and cladding. A protective acrylate coating then surrounds the cladding. In most cases, the protective coating is a dual layer composition [4].

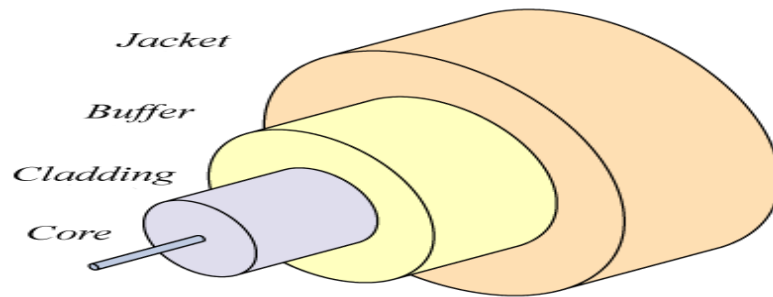

Figure (7) Components of optical fiber cable

1-7 TYPES OF FIBER Optic

Three basic types of fiber optic cable are used in communication systems:

1. Step-index multimode
2. Step-index single mode
3. Graded-index

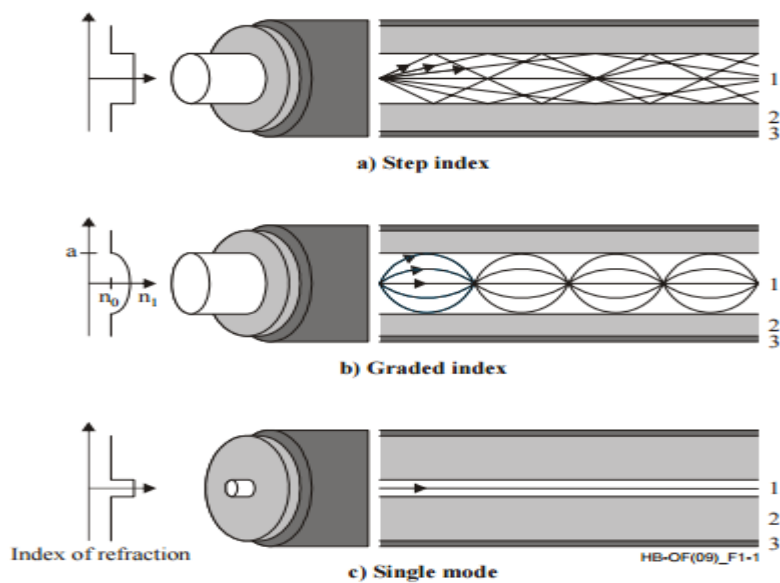

Figure (8) diagram of optical fiber cable types

1-7-1 Step-index Multimode.

Multimode optical fibers are dielectric waveguides which can have many propagation modes. Light in these modes follows paths that can be represented by rays as shown in Figure 8 where regions 1, 2

and 3 are the core, cladding and coating, respectively. The cladding glass has a refractive index, a parameter related to the dielectric constant, which is slightly lower than the refractive index of the core glass [2].

1-7-2 Step index

The fiber in Figure 8-a is called "step index" because the refractive index changes abruptly from cladding to core. As a result, all rays within a certain angle will be totally reflected at the core-cladding boundary. Rays striking the boundary at angles greater than this critical angle will be partially reflected and partially transmitted out through the boundary towards the cladding and coating. After many such reflections, the energy in these rays will eventually be lost from the fiber. Region 3, the coating, is a plastic which protects the glass from abrasion [2].

1-7-3 Graded-index

The different mode velocities can be nearly equalized by using a "graded-index" fiber as shown in Figure 8-b. Here the refractive index changes smoothly from the center out in a way that causes the end-timed travel time of the different rays to be nearly equal, even though they traverse different paths. This velocity equalization can reduce pulse spreading by a factor of 100 or more. By reducing the core diameter and the refractive index difference between the core and the cladding only one mode (the fundamental one) will propagate and the fiber is then "single-mode" (Figure 8-c). In this case there is no pulse spreading at all due to the different propagation time of the various modes [2].

1-8 Optical Fiber Sizes

The international standard for outer cladding diameter of most single-mode optical fibers is 125 microns (μm) for the glass and 245 μm for the coating. This standard is important because it ensures compatibility among connectors, splices, and tools used throughout the industry. Standard single-mode fibers are manufactured with a small core size, approximately 8 to 10 μm in diameter. Multimode fibers have core sizes of 50 to 62.5 μm in diameter. Multimode fibers have core sizes of 50 to 62.5 μm in diameter all the standards as shown in figure 9 below [1].

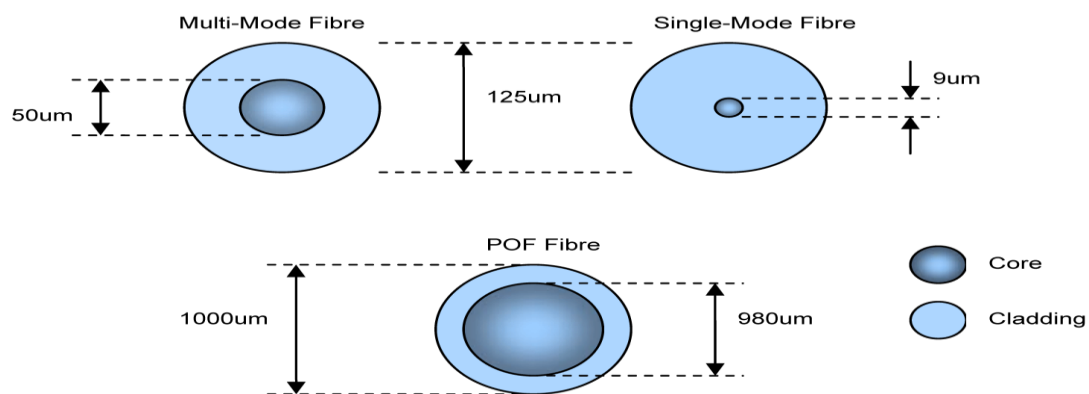

Figure (9) for Sizes of O.F CABELS

1-8-1 Note:

Plastic Optical Fiber (POF) is a unique member of the optical fiber family. POF is made of Poly Methyl Methacrylate (PMMA), with a large core diameter (~ 1 mm) and high numerical aperture (NA 0.3 – 0.5)

1-9 Advantages:

Information can be carried by radio waves transmitted down coaxial cables at a rate of about 10⁷ bits per second. But this can be increased by several orders of magnitude if information is carried as light pulses down an optical fiber. A typical optical fiber cable can carry about 9000 telephone channels, or over 1000 music channels,

or 8 television channels, which is over five times the capacity of the best copper cable.

- Optical fibers can carry information over greater distances without significant attenuation. Copper cables require boosters to be spaced much closer together.
- An optical fiber cable is lighter, smaller and easier to handle than a copper cable.
- Optical signals are free from 'noise' due to electrical interference.
- 'Crosstalk' between adjacent channels is negligible.
- Also, because light waves do not create an external magnetic field (unlike an electric current flowing down a wire), they are far less susceptible to external surveillance.
- Apart from communication, optical fiber can be used as endoscopes in medicine and engineering to 'see' inaccessible places. This means that 'exploratory surgery' can be avoided [5].

1-10 Disadvantages:

- Limited physical arc of cable. Bend it too much and it will break.
- Difficult to splice.
- Physical vibration will show up as signal noise.
- Loss of light in fiber due to scattering. (Attenuation)[5]

1-11 EXPERIMENT:

This nice little experiment is a modern-day recreation of a famous scientific demonstration carried out by Irish physicist John Tyndall in 1870.



Figure (10) Photo showing fiber optic bottle and torch (flashlight)

It's best to do it in a darkened bathroom or kitchen at the sink or washbasin. You'll need an old clear, plastic drinks bottle, the brightest flashlight (torch) you can find, some aluminum foil, and some sticky tape.

1-Take the plastic bottle and wrap aluminum foil tightly around the sides, leaving the top and bottom of the bottle uncovered. If you need to, hold the foil in place with sticky tape.

2- Fill the bottle with water.

3- Switch on the flashlight and press it against the base of the bottle so the light shines up inside the water. It works best if you press the flashlight tightly against the bottle. You need as much light to enter the bottle as possible, so use the brightest flashlight you can find.

4-Standing by the sink, tilt the bottle so the water starts to pour out. Keep the flashlight pressed tight against the bottle. If the room is darkened, you should see the spout of water lighting up ever so slightly. Notice how the water carries the light, with the light beam bending as it goes! If you can't see much light in the water spout, try a brighter flashlight.

- Photo: Seen from below, your water bottle should look like this when it's wrapped in aluminum foil. The foil stops light leaking out from the sides of the bottle. Don't cover the bottom of the bottle or light won't be able to get in. The black object on the right is my flashlight, just before I pressed it against the bottle. You can already see some of its light shining into the bottom of the bottle [6].

1-12 Uses of Fiber Optic Cables

Fiber optic cables find many uses in a wide variety of industries and applications. Some uses of fiber optic cables include:

1. Medical
Used as light guides, imaging tools and also as lasers for surgeries
2. Defense/Government
Used as hydrophones for seismic and SONAR uses, as wiring in aircraft, submarines and other vehicles and also for field networking
3. Data Storage
Used for data transmission
4. Telecommunications
Fiber is laid and used for transmitting and receiving purposes
5. Networking
Used to connect users and servers in a variety of network settings and help increase the speed and accuracy of data transmission
6. Industrial/Commercial
Used for imaging in hard to reach areas, as wiring where EMI is an issue, as sensory devices to make

temperature, pressure and other measurements, and as wiring in automobiles and in industrial settings

7. Broadcast/CATV

Broadcast/cable companies are using fiber optic cables for wiring CATV, HDTV, internet, video on-demand and other applications

Fiber optic cables are used for lighting and imaging and as sensors to measure and monitor a vast array of variables. Fiber optic cables are also used in research and development and testing across all the above mentioned industries [7].

Fiber optic technology has grown tremendously over the years and today can be found in many surprising places. In fact, fiber optics are an essential part of our everyday lives, often times without us even being aware of it [8].

As we mentioned in our previous notes on optics, Alexander Graham Bell experimented with transmitting voice signals over optical "beams" as shown in figure 11, so it's fitting that one of the first uses of fiber optics was the telephone.



Figure (11) experimented with transmitting voice signals

Today, that technology has revolutionized long distance calls, and as our last notes indicated, it's more secure and features less electrical interference than traditional copper wiring. But by far, the most prominent use of fiber optics today is the Internet, which is information sent digitally through fiber optics across the entire world.

Massive undersea fiber optic cables, wrapped in layer upon layer of insulation and protection much like Russian Matryoshka dolls, traverse Earth's oceans to allow people all over the planet to stalk their exes on Facebook and take photos of their food to post on Instagram. It's kind of beautiful when you think about it, really.

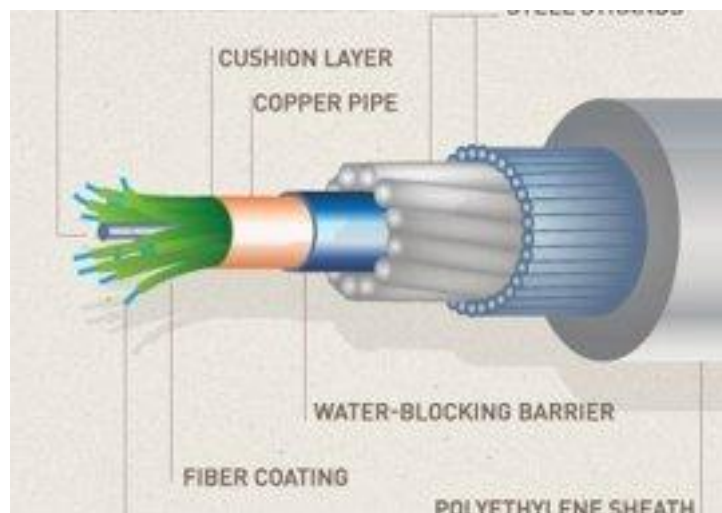

Figure (12) for Traverse Earth's Oceans cable

But that's just one of the myriad applications that employ the use of fiber. Let's check out some others...

1-12-1 Military

Fiber optic technology is in high demand in the military today. The military has tested the cables rigorously and decided they were perfect for use in many of their applications. They offer better performance, more bandwidth, and greater security for their signals – all at a lower cost. They are strong, and more

importantly lightweight, and can also be used outdoors in harsh environments. Thus, optical cabling is an excellent choice for the military's retrieval and deployment applications.

Missile launchers and radar systems have also begun to utilize these benefits. In many of their control systems, a single pencil-sized optical fiber can replace miles (and pounds) of copper wiring.

In 2014, the U.S. Army plans to introduce an Abrams tank that will be almost two tons lighter than the current version, all due to replacing copper wiring with its lighter, faster, more secure counterpart [9].

1-12-2Transportation

The fast-paced transportation system has become a growing market for the use of fiber optics. With the increase in traffic and more demand for efficiency, "smart highways" have begun to adopt fiber into things like automated toll booths, traffic signals, and message signs that are changeable.

One such example can be found in electric trains. Fiber is used as the transmission medium to control the switching of power semiconductors within the converters that create the right frequency and voltage for the electrical drive motors and electrical systems.

What that basically means is that a transformer has to convert the power grid's electricity to a lower voltage. Since the distances traveled to accomplish such conversions can be quite far, fiber provides a much better solution than copper [9].

1-12-3 UAVs & Drones

Yup, drones. A fairly new and fast growing application for fiber optics is Unmanned Aerial Vehicles (UAVs). With the ability to provide a fast and efficient way to transmit a large amount of data over long distances, fiber is utilized as the main communication conduit between the UAV and ground control. Or more specifically, between ground control and the antenna that controls the UAV.



Figure (13) for Yup & drones

And we're not just talking military drones, either. Recently, tiny drones have been entirely powered by "laser over fiber", basically using light and optical cables to make it fly. The fiber

has the added benefit of being lighter than copper wiring, and non-conductive (meaning it won't short out any power lines the UAV happens to bumble into, and it also won't attract pesky lightning strikes) [9].

Not just only for that but we are using fiber optic in other applications in our life, like lighting in our houses as shown in figure 15 or Christmas trees as seen in figure 14, signs, and art. Showcases displayed in boutiques use optical fibers to illuminate from different angles using a single light source.



Figure (14) lighting for Christmas trees using fiber.

In fact, there are many other uses of optical fiber nowadays, as shown in the pictures (indoor decoration, Fiber Optic lighting).

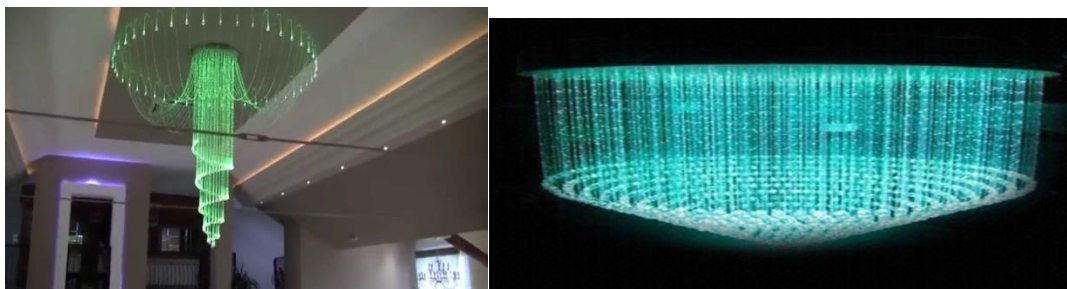

Figure (15) Decoration, Fiber Optic lighting

CHAPTER 2

Desecration for OVD

2-1 Introduction

The advantages provided by optical fiber systems are the result of a continuous stream of product innovations and process improvements. As the requirements and emerging opportunities of optical fiber systems are better understood, fiber is improved to address them. This work provides an extensive introduction of the history, construction, operation, and benefits of optical fiber, with particular emphasis on outside vapor deposition (OVD) process [1].

In this chapter we will present a new kind of processing in optical fiber is called (OVD) outside vapor deposition as we will see the topics below:

1. From Theory to Practical Application: A Quick History.
2. How fiber optics works?
3. Outside Vapor Deposition (OVD).
4. OVD Benefits.

2-2-1 From Theory to Practical Application: A Quick History

An important principle in physics became the theoretical foundation for optical fiber communications: light in a glass medium can carry more information over longer distances than electrical or radio frequency (RF) signals can carry in a copper, coaxial or wireless medium. The first challenge undertaken by scientists was to develop a glass so pure that one percent of the light would be retained at the end of one kilometer (km), the existing unrepeated transmission distance for copper-based telephone systems. In terms of attenuation, this one-percent of light retention translated to 20 decibels per kilometer (dB/km) of glass material. Glass researchers

all over the world worked on the challenge in the 1960s, but the breakthrough came in 1970, when Corning Incorporated scientists Drs. Robert Maurer, Donald Keck, and Peter Schultz created a fiber with a measured attenuation of less than 20 dB per km. It was the purest glass ever made.

Working closely with customers has made it possible for scientists to understand what modifications are required, to improve the product accordingly through design and manufacturing, and to develop industry-wide standards for fiber.

The commitment to optical fiber technology has spanned more than 30 years and continues today with the endeavor to determine how fiber is currently used and how it can meet the challenges of future applications.

As a result of research and development efforts to improve fiber, a high level of glass purity has been achieved. Today, fiber's optical performance is approaching the theoretical limits of silica-based glass materials.

This purity, combined with improved system electronics, enables fiber to transmit digitized light signals hundreds of kilometers without amplification.

When compared with early attenuation levels of 20 dB per km, today's achievable levels of less than 0.35 dB per km at 1310 nanometers (nm) and 0.25 dB per km at 1550 nm, testify to the incredible drive for improvement [1].

2-3 How Fiber Works?

Light travels down a fiber-optic cable by bouncing repeatedly off the walls. Each tiny photon (particle of light) bounces down the pipe like a bobsleigh going down an ice run. Now you might expect a beam of light, traveling in a clear glass pipe, simply to leak out of the

edges. But if light hits glass at a really shallow angle (less than 42 degrees), it reflects back in again—as though the glass were really a mirror. This phenomenon is called total internal reflection. It's one of the things that keeps light inside the pipe.

Artwork: Right: Total internal reflection keeps light rays bouncing down the inside of a fiber-optic cable [1].

The other thing that keeps light in the pipe is the structure of the cable, which is made up of two separate parts. The main part of the cable—in the middle—is called the core and that's the bit the light travels through. Wrapped around the outside of the core is another layer of glass called the cladding. The cladding's job is to keep the light signals inside the core. It can do this because it is made of a different type of glass to the core. (More technically, the cladding has a lower refractive index) [1].

The operation of an optical fiber is based on the principle of total internal reflection. Light reflects (bounces back) or refracts (alters its direction while penetrating a different medium), depending on the angle at which it strikes a surface [1].

One way of thinking about this concept is to envision a person looking at a lake. By looking down at a steep angle, the person will see fish, rocks, vegetation, or whatever is below the surface of the water (in a somewhat distorted location due to refraction), assuming that the water is relatively clear and calm. However, by casting a glance farther out, thus making the angle of sight less steep, the individual is likely to see a reflection of trees or other objects on an opposite shore. Because air and water have different indices of refraction [1].

This principle is at the heart of how optical fiber works. Controlling the angle at which the light waves are transmitted makes it possible

to control how efficiently they reach their destination. Light waves are guided through the core of the optical fiber in much the same way that radio frequency (RF) signals are guided through coaxial cable. The light waves are guided to the other end of the fiber by being reflected within the core [1].

The composition of the cladding glass relative to the core glass determines the fiber's ability to reflect light. That reflection is usually caused by creating a higher refractive index in the core of the glass than in the surrounding cladding glass, creating a "waveguide." The refractive index of the core is increased by slightly modifying the composition of the core glass, generally by adding small amounts of a dopant. Alternatively, the waveguide can be created by reducing the refractive index of the cladding using different dopants [1].

2-3 Outside Vapor Deposition (OVD)

Process Basic OVD optical fiber manufacturing consists of three steps: laydown, consolidation, and draw.

2-3-1 Laydown

In the laydown step, a soot preform is made from ultra-pure vapors as they travel through a traversing burner and react in the flame to form fine soot particles of glass.



Figure (1) Laydown FOR (OVD)

The OVD process is distinguished by the method of depositing the soot. These particles are deposited on the surface of a rotating

target rod. The core material is deposited first, followed by the pure silica cladding. As both core and cladding raw materials are vapor-deposited, the entire preform becomes totally synthetic and extremely pure [1].

2-3-2 Consolidation

When deposition is complete, the bait rod is removed from the center of the porous preform, and the preform is placed into a consolidation furnace. During the consolidation process, the water vapor is removed from the preform. This high-temperature consolidation step sinters the preform into a solid, dense, and transparent glass [1].

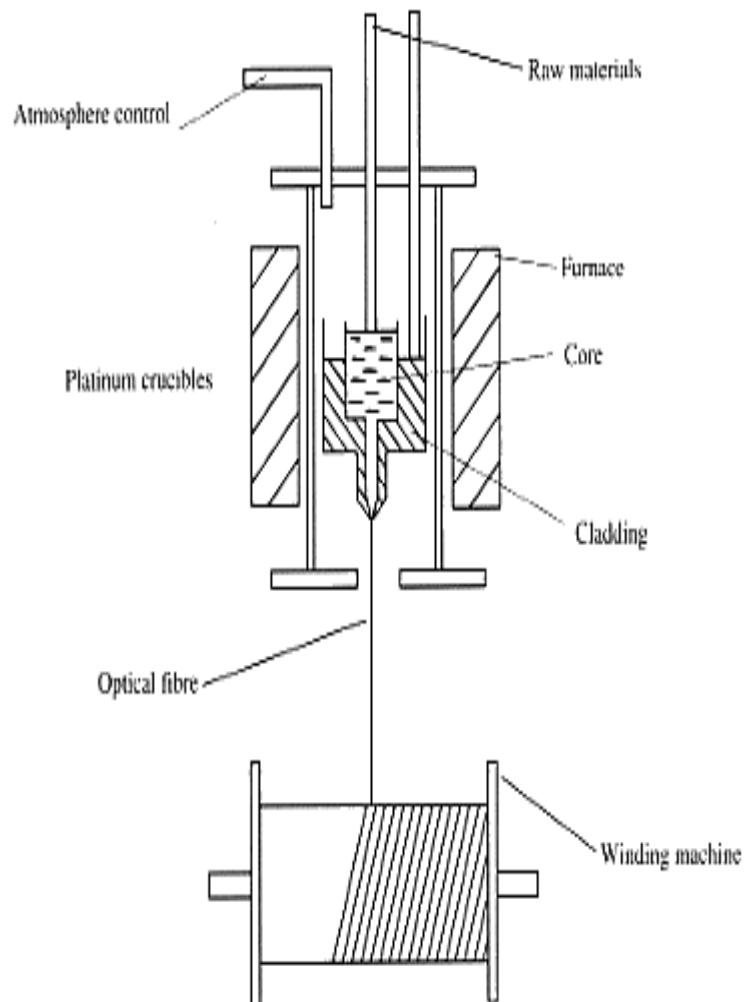

Figure 2 Consolidation step

2-3-3 The Draw

The finished glass preform is then placed on a draw tower and drawn into one continuous strand of glass fiber.

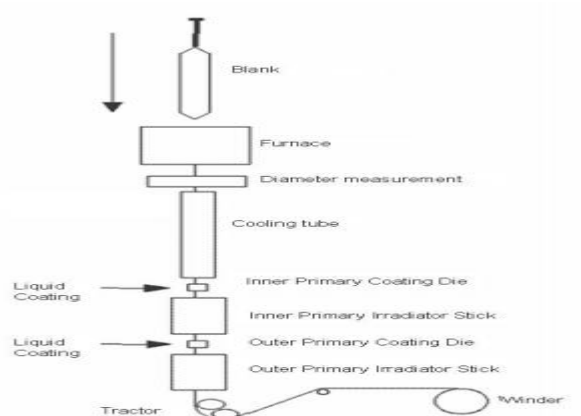

Figure 3 Draw tower

2-3-4 OVD Benefits

Fiber produced using the OVD process is purely synthetic, exhibits enhanced reliability, and allows for precise geometrical and optical consistency. The OVD process produces a very consistent “matched-clad” fiber. OVD fibers are made of a core and cladding glass, each with slightly different compositions. The manufacturing process provides the relationship between these two glasses. A matched-clad, single-mode fiber design allows for a consistent fiber.

The OVD process produces well-controlled fiber profiles and geometry, both of which lead to a more consistent fiber. Fiber-to-fiber consistency is especially important when fibers from different manufacturing periods are joined, through splicing and connectorization, to form an optical system [1].

Chapter 3

Testing of optical fiber cable

3-1 Introduction

Fiber optic cables, like any other cable type, require testing to ensure that they meet the applicable performance level for the application they will be used in. These tests are generally easy to perform, however some tests do require specialized test equipment in addition, to measure the cable we will use different methods and devices.

3-2 Types of Tests

There are three basic tests which are commonly employed to test fiber optic cable. These tests range from very basic to very advance. In order of simplest to most complexes, the common tests performed on fiber optic cabling are:

- "Flashlight" Test.
- Attenuation(Loss)Test.
- Optical Time Domain Reflectometer Test.

3-2-1 "Flashlight" Test

This test is the most basic test possible for a fiber optic cable assembly. It simply checks to see if the cable will carry any light from one end to the other. It does not tell how much light is lost in the cable, nor will it detect where in the cable any fault is located.

To perform the test, simply disconnect both ends of the cable from any equipment and shine the beam of a flashlight as showed in the figure by using the meter with the beam of light or other visible light source in to one end. Next, go to the other end of the cable

and look in to the connector. If the cable is able to carry light, you will see a small point of light in the center of the connector. If the center of the connector is dark, then there is a break somewhere in the cable.

This test may seem too simple; however, it will detect around 90% of the type of faults which cause fiber optic runs to not work. Also, because it does not require any special equipment to perform, it makes a quick test possible in situations where more advanced testing would be difficult or impossible to perform [9].



Figure1 of optical power meter with flashlight

To avoid possible eye damage, NEVER look in to the end of any fiber optic cable connected to any type of equipment!

3-2-2 Attenuation Test

Attenuation testing is the next step up in sophistication from a "Flashlight" test.

This test tells exactly how much light is lost within a fiber optic cable assembly. It requires the use of a Light Source and Optical Power Meter and a reference cable.

An attenuation test basically consists of transmitting light at a known intensity into one end of a cable, and measuring exactly how much comes out the other end. The difference is the loss, or attenuation, of the cable.

The exact testing procedure will vary somewhat depending on the specific make and model of test equipment is being used.

However, the basic steps for an attenuation test are:

- 1.** Obtain an Optical Power Meter and Light Source. These are included in our Fiber Optic Test Kit and Deluxe Fiber Optic Test Kit.
- 2.** Using alcohol and a clean lint-free cloth, clean the end of each connector.
- 3.** Using a pair short cables with a known amount of attenuation ("Reference Cables") coupled together with a Fiber Optic Coupler, connect the Optical Power Meter to the Light Source (see Figure One (A), below).
- 4.** Read the power level indicated on the Optical Power Meter. This number is our baseline transmits level.

NOTE:

Some Optical Power Meters have an "Auto Zero" feature which calibrates the Optical Power Meter to the Light Source - Reference Cable combination. This feature sets a reading of zero ("0") to the combination of reference cable and light source transmit level. The result is that the display of the Optical Power Meter will show the **actual** loss of the cable being tested without having to manually compensate for the transmit level and reference cable losses. This results in faster testing with less chance of error, and should be used whenever it is available. See the Figure below.

5. Disconnect the coupler and insert the cable you want to test between the two Reference Cables. Read the display on the Optical Power Meter. See Figure (B) below.

6. Subtract transmit level determined in Step Two from the reading on the Optical Power Meter. This number is the attenuation of the cable. If the test is performed using a Optical Power Meter calibrated with an "Auto Zero" feature disregard this step.

In such a case, the display of the Optical Power Meter will be the loss of the cable. This is shown in Figure (B) below.

An example of the math used is shown below:

Result of Step Two = -0.6 dBm

Result of Step Six = -2.9 dBm

Subtract Step Six from Step Two: $-2.9 - (-0.6) = -2.9 + 0.6 = -2.3$ dB

This cable has a loss of 2.3 dB

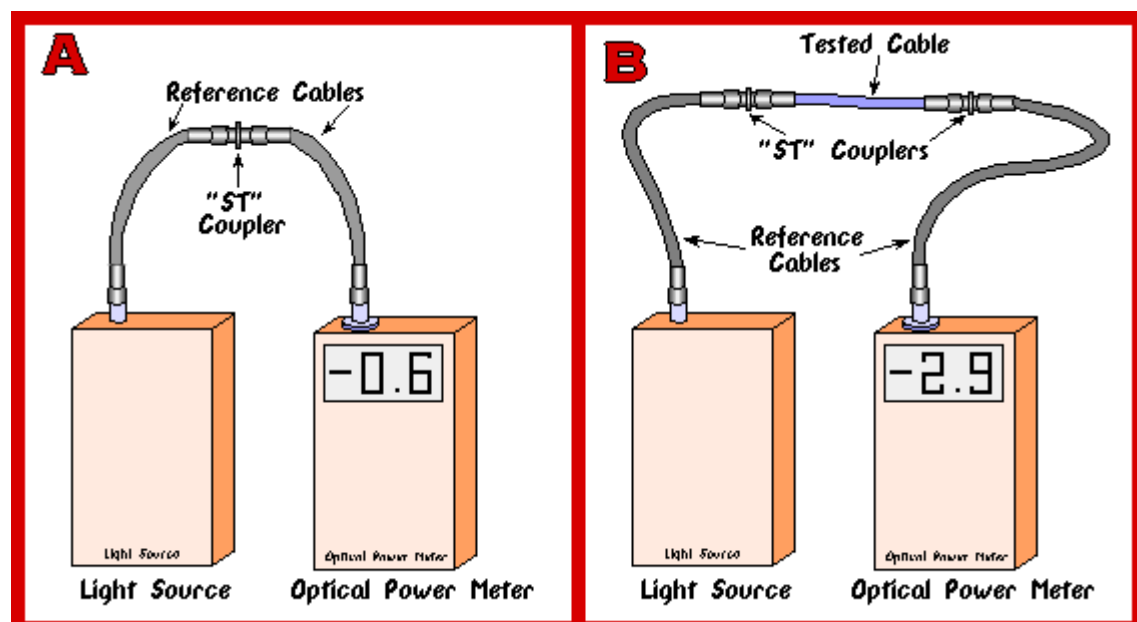

Figure 2 Attenuation Test Without Auto-Zero

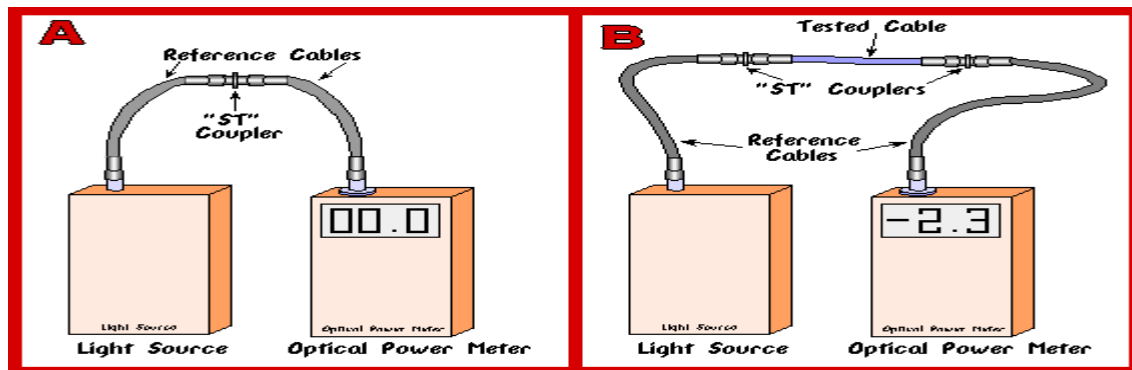

Figure 3 Attenuation Test with Auto-Zero

The results of an Attenuation Test can be useful in troubleshooting a pair of fiber optic devices which will not communicate, but the fiber passes a "Flashlight" Test. Each fiber optic device will usually contain in its instruction manual the transmit level and the minimum receive level it can accept. If we take the transmit level of the device at one end of the cable and subtract from it the loss introduced by the cable run, the result is the signal level being presented to the receiver. This level must be greater than or equal to the receiver sensitivity of the unit being connected. If it happens to be less, then the equipment will not communicate [9].

An example:

For example, assume that we have a pair of fiber optic modems separated by a fiber optic cable run. The manual of the modems states the units have a transmit level of -15 dBm and a receiver sensitivity of -28 dBm. An attenuation test of the cable run between the units reveals that the cable has 16 db of attenuation. Quickly doing our math reveals that:

$$-15 - 16 = -31 \text{ dBm at receiver}$$

Receiver requires -28 dBm or more power. -31 dBm is *less than* -28 dBm, so this setup is not likely to work properly.

3-2-3 Optical Time Domain Reflect meter (OTDR) Testing

The most sophisticated test equipment in general use for fiber optic cable is a device called an **Optical Time Domain Reflect meter**, or OTDR for short as shown below. Although the name may seem intimidating, an OTDR actually uses a simple concept for testing. A "reflectometer" is simply a device which sends a short pulse (usually 1 nanosecond long) of energy in to a cable and measures how much of that energy is reflected back to it. A "Time Domain" Reflectometer is a reflectometer which displays the result of its tests relative to the amount of time elapsed between when it sends the pulse and when it receives any reflections.



Figure 4 of Optical Time Domain Reflectometer

Finally, an "Optical" Time Domain Reflectometer is a TDR which works with fiber optic cable as shown above in figure 4.

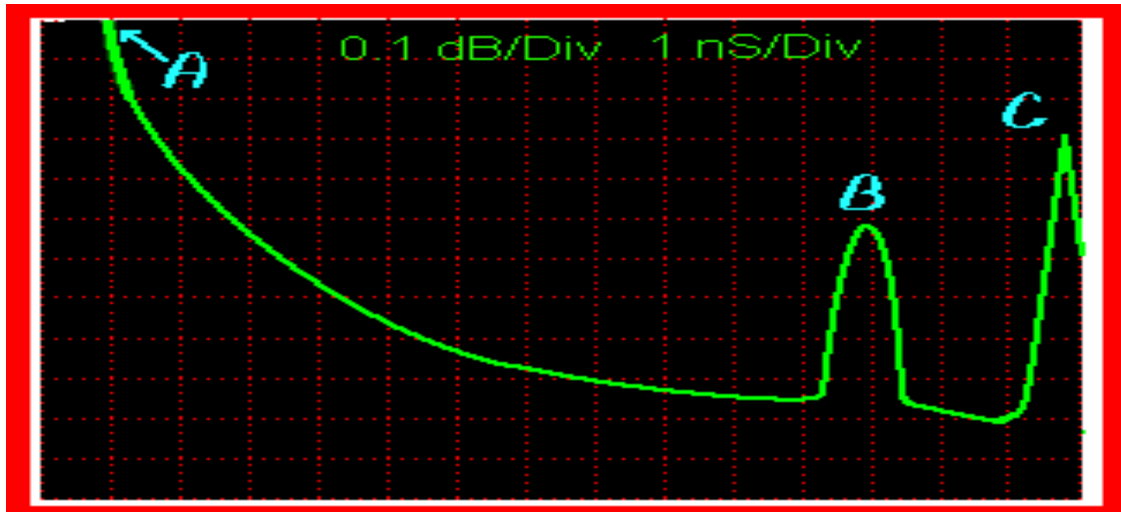

Figure 5 Sample OTDR Display

3-3 OTDR description for the device:

The AQ7275 is one of the best-selling OTDRs in the world. Model lineup has been expanded to a total of 9 models to choose from with a dynamic range of up to 45dB. Wavelength capability spans from 850nm (MMF) to 1650nm (SMF). An impressive 0.8m event dead zone makes this model an excellent choice for FTTH and metro, core networks [12].

Enhancements include a PON option allowing accurate event analysis after a 1x32 splitter with significantly reduced undershoot effects. Also unique to the industry is a built-in section of launch fiber to eliminate the need for a separate launch box.

Latest standard features include the convenient capability to display a fiber connector inspection probe using one of the unit's standard USB I/O ports.

Figure 5 above shows a sample trace from the screen of an OTDR. This display shows the relative reflected light received by the unit over time. Each vertical grid line represents a 0.1 dB difference in power, and each horizontal grid line represents 1 nanosecond of time.

Note that the screen has been annotated with the letters A, B, and C. These letters are not part of the display of the OTDR, rather they are simply markers added to make explaining the trace easier.

At **A**, we have just sent a pulse of light in to the cable and are receiving some light back through the glass. Between **A** and **B** we see only the normal backscatter of the light as it travels through the glass. This shows as a smooth, gradually decreasing curve. At point **B** we see a "spike" in the trace. This spike is caused by a sudden increase in the amount of light received and is usually caused by a break, micro bend, or splice in the cable, and if the result of an attenuation test shows a high loss in the cable, that is the point where it is most likely occurring.

Finally, at point **C** we reach the end of the cable and see another spike in the trace caused by light reflecting off the mirror-like polished end of the fiber.

The information shown in the above OTDR trace can be invaluable in troubleshooting a long fiber optic cable runs because it is not only shows how much of a fault is in the cable, but also where it is.

In the example above, we have a rather major break at a point 12 nS away from the source. Since the propagation speed of light in glass is about 0.3 nS per meter, we know that the fault is at a point roughly 3.6 meters from the end we tested it at. We also know the approximate length of the cable run by the location of point **C** is about 4.4 meters.

Therefore, it would be a good idea to go 3.6 meters away from the OTDR (or 0.82 meters from the other end of the cable) and begin physically examining the cable for splices, breaks, crushes, kinks, or other damage.

The above is a very basic description of OTDR usage. It is beyond the scope of this document to go in to exact detail as to how to operate an OTDR, as each model is different [9].

3-4 Testing Loss with Optical Power Meter

AFL offers an array of tough handheld loss testing solutions designed for outside plant use. AFL optical power meters, light sources, and test kits are necessary tools for technicians working on fiber networks.

A power meter is used to test loss that shown in figure 6, but a test source is needed as well. The meter will measure the optical power that is lost in every part of the cable. The cable is mated with a working reference cable. Two methods used in loss testing are single-ended loss and double-ended loss. With single-ended loss testing, only the launch cable is used. With double-ended loss testing, a receive cable is also attached to the meter [11].

3-5 Description of the testing device:

The NOYES C880 is a fiber optic certification Optical Loss Test Set with Touch and Test® an intuitive visual user interface which simplifies the user experience, reduces training time and testing errors enabling even novice to get the job done accurately. With Tier 1 testing tools including OPM, OLS, VFL and end-face inspection capability the C880 is a compact solution for fiber network owners and installers. Comes w TRM™ reporting software for reports compliant to TIA/ISO guidelines [12].



Figure 6 C880 Certification Optical Loss Test Kit

Other tools that may be required for the processes above include optical loss test kits, matching reference test cables, mating adapters with hybrids, a visual fault locator or fiber tracer, cleaning items, and an ODTR (for outdoor networks).

Fiber optic cables can be of great value to companies if they work properly. Use a fiber optic power meter and other useful tools to ensure that your fiber optic system will operate smoothly around the clock [13].

4 Conclusion

To summarize that, the main advantage of using optical fiber to have contact with others and send and receive billions of information in multi ways (undersea –wireless-cables ... etc.).

Nowadays, Optical fiber widely use and become part of our live in all sciences and manufacturing.

Fiber optic cables require testing to ensure that they work properly. These tests can be as simple as shining a light in one end and looking for it at the other end to scanning the cable with an OTDR. Simple tests only give very basic information, and more advanced tests give more information, but the cost and difficulty of use of the equipment increases rapidly with the sophistication of the test. An OTDR is required to find the location of faults within a cable, and a light source/optical power meter combination are required to perform Attenuation Tests.

5 References:

1. Corning discovering Journal of materials science, Fiber-Optic Technology of Communication beyond imagination library of leading innovators.
2. Physics 1501 - Modern Technology, Randy Kobes & Gabor Kunstatter, Physics Department, University of Winnipeg, September, 1999(http://theory.uwinnipeg.ca/mod_tech/node114.html).
3. Understanding Optical Communications, September 1998, Harry J. R. Dutton, First Edition, SG24-5230-00
4. Optical fiber, cables and systems, 2009, Malcolm Johnson Director, Printed in Switzerland-Geneva, ITU-T Manual Telecommunication Standardization Sector.
5. [MiniPhysics](https://www.miniphysics.com/advantages-disadvantages-of-optical.html) website(<https://www.miniphysics.com/advantages-disadvantages-of-optical.html>)
6. Explainthatstuff electronic journal (<http://www.explainthatstuff.com/fiberoptics.html>) (Last updated: August 16, 2015)
7. Optical Fiber Communications Principles and Practice, 2009, John M. Senior assisted by M. Yousif Jamro (Third edition).
8. *An Electronic company CABLE MANAGEMENT*
<http://www.cableorganizer.com/articles/fiber-optics-tutorial/fiber-optic-technology.html> (written by: Shane Weaver 2002-2015)
9. <http://www.maznets.com/tech/fiber.htm> (n.d)
10. Electronic journal Cable Organizer (<http://www.cableorganizer.com/articles/fiber-optics-tutorial/power-meters.html>).
11. AFL Communication company for optical fiber cable <https://www.aflglobal.com/Products/Test-and-Inspection/Loss-Testing/Loss-Test-sets.aspx>

12. YOKOGAWA ELECTRIC CORPORATION
<http://tmi.yokogawa.com/es/discontinued-products/optical-measuring-instruments/optical-time-domain-reflectometer/aq7275-optical-time-domain-reflectometer/>
(December 31,2014)
13. AFL Communication company for optical fiber cable
<https://www.aflglobal.com/Products/Test-and-Inspection/Loss-Testing.aspx>.
14. IPROBOT ELECTRIC JOURNAL
<http://www.iprobot.net/uncategorized/network-cables/>
November 23, 2010).
15. *Fiber-Optic Communications Systems*, 2002, John Wiley & Sons, Inc. Govind P, *Third Edition*.

CURRICULUM VITAE

PERSONAL INFORMATION

Surname, Name: ALSHARIF ABDULGADER.

Nationality: LIBYAN.

Date and Place of Birth: 02/06/1987 Murzuk

Phone: +905393002932

E-mail: abdelkaderalsharif@gmail.com

EDUCATION:

Degree	Institution	Year of Graduation
BS	Civil aviation technology & metrology (Asbiaa college-Tripoli - Libya).	2010-2011
High school	Secondary engineering science , Murzuq	2006-2007

WORK EXPERIENCE:

Place	Year	Enrolment
Institute of Electrical & electronic professions (MURZUQ).	2013	TRAINER
Islamic ministry	2008-2013	Teacher
A SAP course in CPUT -CAPE TOWN-SOUTH AFRICA	2014	Trainer

FOREIGN LANGUAGES

1. Arabic.
2. English.