

Understanding exhaust gas treatment systems

Guidance for shipowners and operators

June 2012



Lloyd's
Register

LIFE MATTERS

Cover image: Downtown Seattle and port

(These waters will form part of the North American Emission Control Area (ECA) once it enters into effect in August, 2012.)

First published June 2012

Lloyd's Register, its affiliates and subsidiaries and their respective officers, employees or agents are, individually and collectively, referred to in this clause as the 'Lloyd's Register Group'. The Lloyd's Register Group assumes no responsibility and shall not be liable to any person for any loss, damage or expense caused by reliance on the information or advice in this document or howsoever provided, unless that person has signed a contract with the relevant Lloyd's Register Group entity for the provision of this information or advice and in that case any responsibility or liability is exclusively on the terms and conditions set out in that contract.

Copyright © Lloyd's Register. 71 Fenchurch Street, London EC3M 4BS, 2012.

Except as permitted under current legislation no part of this work may be photocopied, stored in any medium by electronic means or otherwise, published, performed in public, adapted, broadcast, transmitted, recorded or reproduced in any form, without the prior written permission of the copyright owner. Enquiries should be directed to the above address.

Where Lloyd's Register has granted written permission for any part of this publication to be quoted such quotation must include appropriate acknowledgement to Lloyd's Register.

Contents

Understanding exhaust gas treatment systems

Contents	1
Figures and tables	2
1 Introduction	3
2 How to use the key	6
3 Air pollution regulations and controls	7
3.1. MARPOL Annex VI	7
4 Exhaust gas treatment systems (EGTS)	9
4.1 Flexibility	9
4.2 The risk of non compliance	9
4.3 Backpressure	9
4.4 EGTS bypass	10
4.5 Exhaust gas velocity	10
4.6 Integration of multiple combustion devices	10
4.7 Maintenance, crew training and workload	11
5 EGTS approvals	12
5.1 Statutory approvals	12
5.2 Class approvals	13
5.3 Independent verification	13
6 SO_x scrubbers	14
6.1 SO _x scrubber technologies	14
6.2 Wet SO _x scrubbers	14
6.3 Wet SO _x scrubbers – open loop	15
6.4 Wet SO _x scrubbers – closed loop	15
Case study 1 – Open loop SO _x scrubber	16
6.5 Wet SO _x scrubbers – hybrid	19
Case study 2 – Hybrid SO _x scrubber	20
6.6 Common aspects of wet SO _x scrubbers	22
6.7 Dry SO _x scrubbers	26
6.8 Comparing SO _x scrubber technologies	28
7 NO_x-reducing devices	31
7.1. Selective catalytic reduction (SCR)	32
7.2. Exhaust gas recirculation (EGR)	36
Appendix A1 Impacts of marine exhaust emissions on human health and the environment	40
Appendix B1 MEPC 184(59) – Exhaust Gas Cleaning System Guidelines	42
Appendix B2 NO _x Technical Code	47
Appendix B3 Regional, national and local regulations	48
Appendix C Chemical reactions	50
Acronyms and abbreviations	51
References	52

Figures and tables

Figures

Figure 1:	The hierarchy of exhaust gas treatment systems	6
Figure 2:	The key	6
Figure 3:	The MARPOL Annex VI fuel oil sulphur limits	7
Figure 4:	Current and future Emission Control Areas (ECAs)	8
Figure 5:	MARPOL Annex VI diesel engine NO _x control schedule	8
Figure 6:	ID fans in exhaust ducts	10
Figure 7:	Water vapour in exhaust gas plume after passing through wet SO _x scrubber	14
Figure 8:	Open loop SO _x scrubbing system	15
Figure 9:	Closed loop SO _x scrubbing system	18
Figure 10a:	Hybrid SO _x scrubbing system in open loop mode	19
Figure 10b:	Hybrid SO _x scrubbing system in closed loop mode	19
Figure 11:	21MW hybrid scrubber during installation on <i>Ficaria Seaways</i>	21
Figure 12:	Washwater treatment system with GRE piping	22
Figure 13:	Multi-stage washwater treatment system used with closed loop scrubbers	22
Figure 14:	Hydrocyclone liner	24
Figure 15:	Washwater instrumentation	25
Figure 16:	Dry SO _x scrubber system	26
Figure 17:	Calcium hydroxide granules	27
Figure 18:	Marine SCR arrangement – four-stroke medium-speed engine	32
Figure 19:	Catalyst element fouling	33
Figure 20:	SCR arrangement – two-stroke low-speed engine	34
Figure 21:	EGR system arrangement – two-stroke low-speed engine	36
Figure 22:	Graphic of the second-generation EGR system	37
Figure 23:	Continuous emissions monitoring systems	44
Figure 24:	Washwater discharge pH limits	45

Tables

Table 1:	Statutory approval requirements for EGTS	12
Table 2:	Typical stages in a closed loop washwater treatment system	24
Table 3:	Comparison of SO _x scrubber technologies	29
Table 4:	Fuel oil sulphur limits recorded in MARPOL Annex VI regulations 14.1 and 14.4 and corresponding emissions values	42
Table 5:	Scrubber document requirements	43
Table 6:	Key regional, national, and local regulations	48
Table 7:	California fuel regulation requirements	49

1. Introduction

Lloyd's Register has been at the forefront of understanding emissions to air from marine diesel engines since we started our Marine Exhaust Emissions Research Programme ^[1], which assessed the nature and magnitude of shipping's contribution to atmospheric pollution.

Exhaust emissions from marine diesel engines mainly comprise nitrogen, oxygen, carbon dioxide (CO₂) and water vapour, plus smaller quantities of nitrogen oxides, sulphur oxides, carbon monoxide, various hydrocarbons at different states of combustion and complex particulate matter (PM). It is these smaller quantities, together with CO₂, that are of most concern to human health and the environment. Adverse effects are experienced at local, regional and global levels. Appendix 1 provides further information about these impacts, which include contribution to climate change through increasing concentrations of CO₂ in the atmosphere; respiratory damage; cancers and genetic mutation; and damage to the natural and built environment.

The regulatory framework

In response to these impacts the International Maritime Organization (IMO), through its Marine Environment Protection Committee (MEPC), introduced regulations for the prevention of air pollution under Annex VI of the MARPOL Convention.

The Annex imposes a framework of mandatory limits on emissions of sulphur oxides (SO_x) and nitrogen oxides (NO_x) both globally and within designated sea areas, known as Emission Control Areas (ECAs). These are regions where neighbouring states have shown that emissions to air have particular impacts on human health and the environment.

In parallel with Annex VI, a number of regional, national and local regulators have introduced their own controls, leading to a patchwork of regulatory requirements.

Section 3 of this publication gives an overview of MARPOL Annex VI, and Appendix B3 includes a summary of the main regional, national and local regulations. At Lloyd's Register we monitor and influence the development of environmental regulations at MEPC as a participant in national and observer delegations.

Exhaust gas treatment systems^a

As emission limits become more stringent, compliance becomes more challenging and costly. There are a number of compliance options, each of which has different technical and operational challenges.

To meet reduced SO_x emission limits, ships can operate on low-sulphur residual and distillate fuels, and in the longer term alternatives such as LNG (liquefied natural gas), biofuels, DME (dimethyl ether) and methanol may provide solutions. The alternative to these options are exhaust gas treatment systems (EGTS) known as SO_x scrubbers, which clean the exhaust gas to reduce SO_x emissions to a level that is equivalent to the required fuel sulphur content. This offers the flexibility to either operate on low-sulphur fuels or to use higher sulphur fuels.

Exhaust gas treatment systems for NO_x, known as NO_x-reducing devices, provide the flexibility to operate ships constructed after 1 January, 2016 inside Emission Control Areas designated to control NO_x emissions (ECA-NO_x).

This guidance provides an understanding of: the different exhaust gas treatment technologies; what to consider when deciding whether or not to install an exhaust gas treatment system; and the practical challenges of installing and operating these systems on board ships.

Section 4 describes the issues common to both SO_x scrubbers and NO_x-reducing devices; section 6 covers SO_x scrubbers; and section 7 covers NO_x-reducing devices.

At the time of publishing this guidance, every effort has been made to ensure that it reflects the current status of EGTS technology and emission regulations. We will be updating it regularly. To download the latest version visit www.lr.org/eca or to purchase a hard copy visit the Lloyd's Register webstore: www.webstore.lr.org

We would like to thank Shipping Emissions Abatement and Trading (SEaT) for their valuable input to this publication.

^a The term exhaust gas treatment system (EGTS) is used in this guidance to refer collectively to SO_x scrubbers and NO_x-reducing devices. This is to avoid confusion with the term 'exhaust gas cleaning system', which the MEPC uses to refer to SO_x scrubbers only.



A ship leaving PortMiami, which will form part of the North American Emission Control Area (ECA)



2. How to use the key

A key is included throughout this guidance to show you which types of EGTS each section covers.

SO_x scrubbers are indicated by solid yellow boxes while NO_x-reducing devices are indicated by solid blue boxes.

Grey boxes indicate EGTS that are not covered within the section.

Figure 1 shows the hierarchy of systems covered by the guidance while figure 2 shows how the key appears on each page.

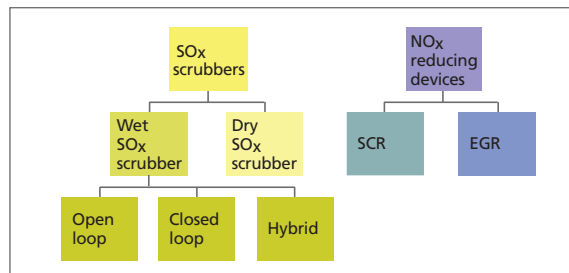

Figure 1: The hierarchy of systems covered by this guidance.

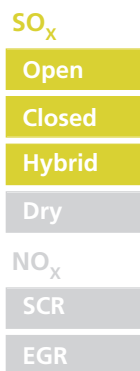

Figure 2: The key as it appears on each page. This section covers wet open loop, closed loop and hybrid SO_x scrubbers.

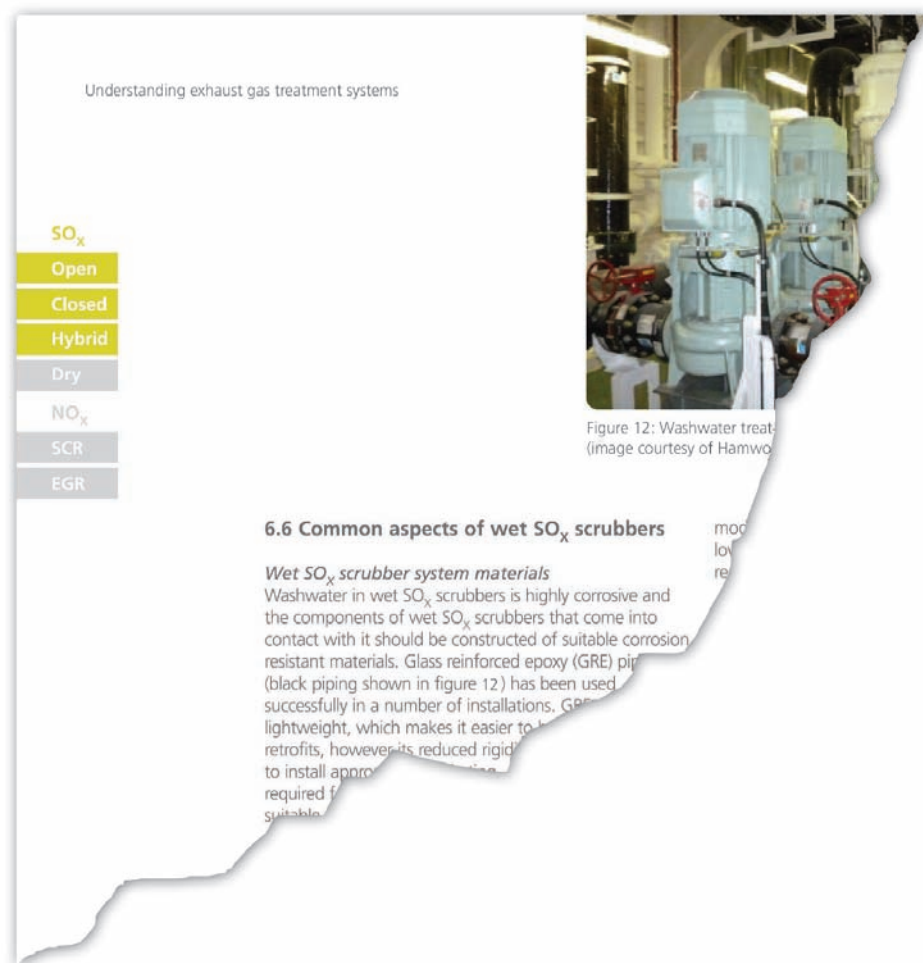

Figure 12: Washwater treatment (image courtesy of Hamworthy)

6.6 Common aspects of wet SO_x scrubbers

Wet SO_x scrubber system materials

Washwater in wet SO_x scrubbers is highly corrosive and the components of wet SO_x scrubbers that come into contact with it should be constructed of suitable corrosion resistant materials. Glass reinforced epoxy (GRE) pipe (black piping shown in figure 12) has been used successfully in a number of installations. GRE is lightweight, which makes it easier to handle during retrofits, however its reduced rigidity may require more to install appropriate supports. The amount of support required for GRE pipe depends on the span length and suitable

3. Air pollution regulations and controls

International, regional, national and local instruments regulate emissions of SO_x, NO_x and particulate matter from ships. In response to greater concern about air quality the extent and complexity of regulation have increased while emissions limits have become tougher. Annex VI of the IMO MARPOL Convention applies to all ships trading internationally and has been used as the basis for many other regional, national and local regulations.

Once the lowest limits for SO_x and NO_x come into force, the exhaust emission limits for ships engaged in international trade will still be higher than the current limits for emissions from land-based industry, land-based transportation and air freight, when considered on the basis of sulphur content of fuel consumed or an engine's NO_x emissions in g/kWh. However, when considered on the basis of unit of emission per unit of transport work delivered (e.g. SO_x per teu-km) the emissions of ships will be lower than other forms of transportation due to shipping's significantly higher transport efficiency.

3.1 MARPOL Annex VI

MARPOL Annex VI regulates the emissions from ships engaged in international trade and regulations 4, 13 and 14 are particularly relevant.

Regulation 14

Regulation 14 places limits on the sulphur content of fuel to restrict SO_x and particulate matter emissions, and is applicable to all ships in service. The regulation specifies different limits for operating inside and outside an Emission Control Area for SO_x (ECA-SO_x) and these follow a stepped reduction over time, as shown in Figure 3.

Two ECA-SO_x – the Baltic and the North Sea (which includes the English Channel) – are currently in effect and well established. From 1 August, 2012, a third – the North American ECA-SO_x – will enter into effect, while a fourth – the US Caribbean ECA-SO_x – is intended to enter into effect in January 2014. Figure 4 shows the geographical extent of these areas.

Regulation 4

Regulation 4 allows flag administrations to approve alternative means of compliance that are at least as effective in terms of emissions reduction as the prescribed sulphur limits. This means that a ship may operate using a fuel with a sulphur content higher than that allowed by regulation 14 as long as an approved SO_x scrubber can reduce the SO_x emissions to a level that is equivalent to, or lower than, the emissions produced by compliant fuel. If a SO_x scrubber is fitted, it must be approved and

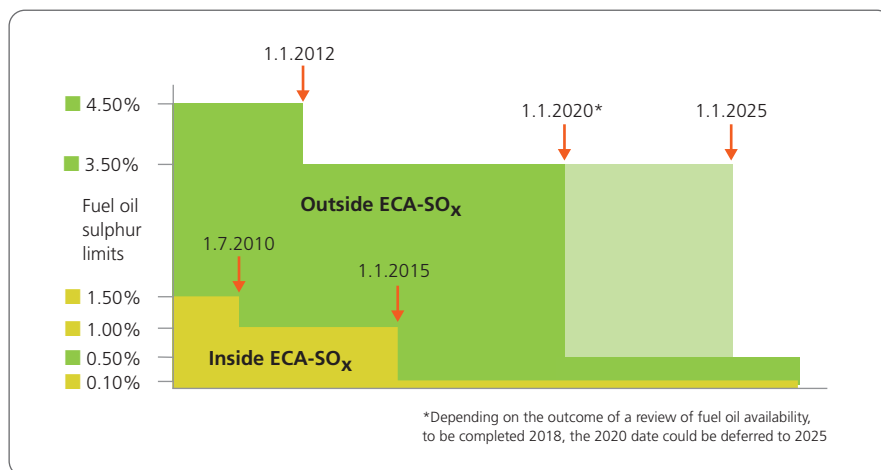

Figure 3: The MARPOL Annex VI fuel oil sulphur limits



Figure 4: Current and future Emission Control Areas (ECAs)

verified as compliant in accordance with the IMO Exhaust Gas Cleaning Systems Guidelines (MEPC 184(59) – 2009 Guidelines for Exhaust Gas Cleaning Systems^[2]).

The Guidelines specify two testing, survey, certification and verification schemes:

- Scheme A – initial approval and certification of performance followed by in-service continuous monitoring of operating parameters plus daily spot checks of the SO₂/CO₂ emission ratio; and
- Scheme B – continuous monitoring of SO₂/CO₂

emission ratio using an approved system with in-service daily spot checks of operating parameters.

In either case any washwater discharged to sea must also be continuously monitored. Appendix B1 contains more detailed information on these Guidelines.

Regulation 13

Regulation 13 places limits on the NO_x emissions of marine diesel engines. The limits are divided into three 'Tiers' whose applicability depends on the ship's construction date (or the date of installation of additional or non-identical replacement engines) and the engine's rated speed (n), as shown in Figure 5. Tier I and Tier II limits are applicable to engines installed on ships constructed on or after 1 January, 2000, and January 1, 2011 respectively.

Subject to a review of enabling technologies, Tier III limits will apply to ships constructed on or after January 1, 2016 when operating inside an ECA-NO_x. Currently, two ECA-NO_x will be in effect in 2016; the North American ECA-NO_x and the US Caribbean ECA-NO_x. These will also be ECA-SO_x (see 'Regulation 14' on page 7).

NO_x Technical Code

The NO_x Technical Code 2008^[3] contains mandatory procedures for the testing, survey and certification of marine diesel engines. Further details are included in Appendix B2.

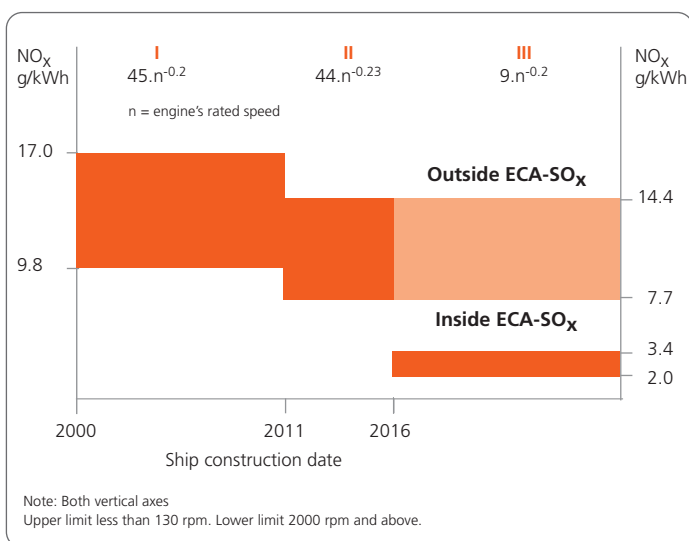

Figure 5: MARPOL Annex VI diesel engine NO_x control schedule

4. Exhaust gas treatment systems (EGTS)

SO_x

Open

Closed

Hybrid

Dry

NO_x

SCR

EGR

For the purposes of this guidance, EGTS are divided into SO_x scrubbers and NO_x-reducing devices. There is at least one exhaust gas treatment system on the market that claims to reduce SO_x, NO_x and CO₂ using electrolysis or electromagnetic techniques, but at the time of writing there is not enough information available on the underlying technology to make any meaningful comment on its applicability and operation.

Issues specific to SO_x scrubbers and NO_x-reducing devices are covered in Sections 6 and 7, but there are a number of issues, outlined in this section, that apply to both.

4.1 Flexibility

One of the benefits of EGTS is that they offer operational flexibility. A SO_x scrubber allows an operator to meet emission limits by either using low-sulphur fuels or by using the SO_x scrubber to clean the exhaust gas. NO_x-reducing devices will offer ships constructed after 1 January, 2016 the flexibility to operate inside ECA-NO_x (see section 3.1).

4.2 The risk of non-compliance

Consideration should be given to both the likelihood and consequences of the failure of an EGTS when it is used to comply with mandatory regulation.

The likelihood of failure will depend on the reliability of the system components and the redundancy included in the system's design. Building in redundancy reduces the likelihood that the system as a whole will fail. For example, designing a wet SO_x scrubber with three pumps each capable of meeting 50% of the washwater pump demand would allow the scrubber to continue to operate in the event of a single pump failure. Other areas where redundancy can be built in include the exhaust gas and wash water monitoring systems.

The consequences of an EGTS failure will depend on whether the ship can employ alternative means to comply with the requirements. For example, in the event of a main engine SO_x scrubber failing a ship may be able to bypass the scrubber and use compliant

fuel. Sufficient compliant fuel will need to be stored on board if this is to be used in the event of a scrubber failure. However, if no compliant fuel is available the ship would no longer be able to comply with the applicable regulations. It is worth noting that the integration of multiple exhaust streams into a single scrubber does exacerbate the consequences of the system failing.

How flag and port states will respond in the event that a ship cannot comply is not yet apparent, but one possible outcome would be to require the ship to sail to the nearest port until either the EGTS has been fixed or an alternative method of compliance is available. The commercial consequence of such a delay will depend on the ship's trading pattern.

Understanding the likelihood and consequences of a failure of an EGTS will allow informed decisions to be made on the amount of redundancy to be designed into the system.

4.3 Backpressure

Engine manufacturers include a permitted range of exhaust backpressures within the technical specifications of their engines – operating outside this range may lead to accelerated wear, greatly reduced maintenance intervals, reduced power and increased fuel consumption. In addition, an engine's NO_x Technical File may also specify a range of permissible backpressures – operating outside this range will invalidate the engine's NO_x approval.

EGTS intrinsically increase backpressure and system designers need to understand the impact of this on the engine. If the EGTS will increase backpressure to a level outside allowable operating limits, it may be reduced by adding an induced draft fan (ID fan) into the exhaust duct (see Figure 6).

Build up of deposits within the EGTS components (for example soot clogging of demisters or deposits on selective catalytic reduction (SCR) catalysts) will increase backpressure while the ship is in operation.



Figure 6: ID fans in exhaust ducts (image courtesy of Hamworthy-Krystallon)

Monitoring the pressure differential across the EGTS will indicate if cleaning is required. Some of these deposits can present a significant health and safety risk to people entering the EGTS to carry out maintenance and cleaning activities.

4.4 EGTS bypass

A bypass provides an alternative path for the exhaust gas so that it avoids the EGTS. When the bypass is 'closed' exhaust gas will pass through the EGTS and when it is 'open' the exhaust gas will exit the ship without passing through the EGTS. Some wet SO_x scrubbers are designed to 'run dry' whereas others may be damaged if hot exhaust gas is passed through them while they are not operating. For systems not designed to run dry, the bypass damper can be interlocked with the EGTS controls to provide a failsafe protection.

Opening the bypass when the EGTS is not operating will prevent a build up of soot and unburned hydrocarbons within the system. When the bypass is open it might also be possible to undertake

maintenance of the EGTS while the associated engine(s) is running (although care should be taken as the bypass damper is not a secure means of isolating the EGTS chamber).

4.5 Exhaust gas velocity

The introduction of EGTS may slow the exhaust gas and any cooling will slow it down further. Consequently, to ensure the exhaust gas clears the ship, the exhaust duct outlet may have to be redesigned to increase the velocity of the gas as it exits the funnel. While relevant to all ships, this is particularly important for cruise ships and ferries. Care must be taken to ensure that the resulting increase in backpressure is acceptable (see section 4.3).

4.6 Integration of multiple combustion devices

It is possible to combine the exhausts from a number of different combustion devices into a single EGTS. This may be necessary due to space restrictions, or simply to reduce the cost of the installation.

The practice of combining exhausts is uncommon within the marine industry where typically each engine has its own independent intake and exhaust. Concerns arising from combining exhausts include:

- backflow of exhaust gas into the exhaust duct of combustion devices that are not operating
- increased backpressure when two or more combustion devices are combined that have different exhaust gas flow characteristics; and
- designing the EGTS to operate effectively over a wide range of exhaust gas flow rates.

Dampers might be required for each exhaust to preclude the back flow of exhaust gas into the exhaust of combustion devices that are not operating. Monitoring is required to confirm that the backpressure on each device remains within allowable limits.

4.7 Maintenance, crew training and workload

It is important to understand the impact of EGTS maintenance on system availability. For instance, annual inspection and cleaning of the SCR chamber will result in the SCR system not being available for

a period of time, which may impact the availability of the ship to operate in an ECA-NO_x. The cleaning will either need to be scheduled while the ship is operating in locations where the SCR system is not required or the ship might have to be taken out of service.

Hazardous chemicals are used in a number of EGTS and adequate controls should be put in place to protect ships' staff. There is also a possibility of further hazardous chemicals and compounds (such as ammonium bi-sulphate in SCR systems) being generated. These will require robust procedures and crew training, as well as adequate signage and personal protective equipment (PPE).

Crew training should cover the normal operation of the EGTS, including bunkering of any chemicals (consumables), calibration of sensors and routine maintenance, as well as the procedures to be followed in case of system failure and deviation from normal operation.

The additional workload associated with system operation and maintenance should be assessed. If it is significant, measures may need to be implemented to prevent crew fatigue.

SO_x

Open

Closed

Hybrid

Dry

NO_x

SCR

EGR

5. EGTS approvals

As with most shipboard equipment installed to meet a regulatory requirement, EGTS require both statutory certification (issued by, or on behalf of, a flag administration) to show that the equipment meets the required performance criteria, and classification society approval (class approval) to show that the equipment does not present an unacceptable risk to the ship and the essential equipment required for the ship's continued operation.

There are a number of different statutory and class approvals associated with exhaust gas treatment systems and their ship-specific installation. In addition to these formal approvals equipment manufacturers and operators may also wish to undertake independent verification of the performance of either a given equipment design (Type Approval) or the performance of a ship-specific installation (verification of performance).

5.1 Statutory approvals

Table 1 shows the statutory approval requirements for EGTS. These are described in more detail in Appendices B1 and B2.

Scheme A statutory approval of SO_x scrubbers is sometimes referred to as 'type approval'. **Note:** this is different to Lloyd's Register Type Approval, described in section 5.3, which involves independent verification of performance against standards specified by the equipment manufacturer.

For statutory approval, the equipment manufacturer should provide equipment with all of the approved documentation required to demonstrate compliance.

Statutory – flag state ship-specific approval

(May be delivered by the ship's class society acting as a recognised organisation if authorised by the flag state)

SO _x scrubber	<p>IMO MEPC 184(59) – 2009 Guidelines for Exhaust Gas Cleaning Systems^{b 2}.</p> <p>Scheme A: Technical and Operating Manuals including SECP Initial shop or onboard test of scrubber Daily monitoring of SO₂/CO₂ Continuous monitoring of key operating parameters Continuous monitoring of washwater</p> <p>Scheme B: Technical & Operating Manuals including SECP No shop or onboard test of scrubber Continuous onboard monitoring of SO₂/CO₂ Daily monitoring of key operating parameters Continuous monitoring of washwater</p> <p>Deliverable: Approved documentation (including Scheme A Certificate if applicable) and post-installation Initial Survey</p>
NO _x reducing device	<p>Engine specific – certified entity is 'engine + device'</p> <p>Reviewed against NO_x Technical Code 2008</p> <p>Technical File (including Onboard NO_x Verification Procedure) Engine group / family certification Pre-certification Survey</p> <p>Deliverable: 'engine + device' certificate supported by approved documentation and post-installation Initial Survey</p>

Table 1: Statutory approval requirements for EGTS

^b These Guidelines apply to wet systems; it is anticipated that guidelines for dry scrubbers will be submitted at MEPC 64 in October 2012

5.2 Class approvals

Class unit approval

Equipment manufacturers may ask Lloyd's Register for a class unit approval to assess the impact of their equipment on the safety of a generic ship and its associated systems by checking for compliance with our *Rules and Regulations for the Classification Of Ships* (the LR Rules). Specific Rules for EGTS will be included within the LR Rules from July 2013; these will ensure that EGTS are comprehensively and consistently approved, and will provide stakeholders with information on Lloyd's Register's requirements.

Class unit approval is a desk top review and includes an assessment of all of the hazards introduced by the system and any proposed mitigation measures. Typically the documentation required for the review is a mixture of equipment construction drawings and schematic drawings of associated systems and is not based on an actual installation. In all cases the equipment manufacturer is required to submit a comprehensive risk assessment for their system. Hazards might include backpressure, corrosion, loss of containment of hazardous chemicals, fire, overpressure and flooding.

Class unit approval may take a long time to complete and require a number of additional document submissions as the approval progresses. Completion of class unit approval will significantly streamline ship-specific class approvals of subsequent installations.

Class approval of ship-specific EGTS installation

Class approval of a ship-specific installation is required for a ship to remain in 'class' with its classification society. The approval includes a document review and onboard survey, and is informed by the class unit approval. The approval focuses on the impact of the system on the safety of the ship and covers ship-specific piping installations, electrical and control installations, and structural modifications.

5.3 Independent verification

Lloyd's Register Type Approval

LR's Type Approval service provides equipment manufacturers with independent confirmation of the performance of their products. It is applicable to series production of equipment whose critical components remain unchanged and typically the units are surveyed on a sample basis (as opposed to surveying every unit). The scope of the approval is specified by the equipment manufacturer and agreed by Lloyd's Register. For EGTS the scope of the Type Approval might include one or more of the following:

- compliance with statutory requirements (performance standard)
- class unit approval (to confirm that the unit does not present unacceptable risk to the ship)
- compliance with specified maintainability and durability standards.

To apply for Type Approval the equipment manufacturer submits documents and plans and, depending on the scope of the approval, performance tests may also be required. As Type Approval does not follow a defined scope it is important to note what the equipment-specific Type Approval documents state; Type Approval is not a panacea.

Note: aspects such as EGTS functionality, reliability and durability are not included within any of the statutory approvals, class unit approval or class approval of ship-specific installation.

Verification of performance

LR can also provide independent verification of EGTS in-service performance. This service is delivered by exhaust emissions specialists experienced in exhaust gas measurement, analysis and legislative interpretation, who are familiar with working on board ships.

SO_x

Open

Closed

Hybrid

Dry

NO_x

SCR

EGR

6. SO_x scrubbers

To meet SO_x emission limits, ship operators currently have two main options: using low-sulphur fuels or using a SO_x scrubber, if permitted (see table 5 in Appendix B3). The choice depends on a number of factors, including the cost of compliant low-sulphur fuels, the capital expenditure (CAPEX) and operating expenditure (OPEX) of the SO_x scrubber, and the amount of time that the ship is expected to spend inside ECA-SO_x.

We have developed the 'ECA Calculator' to help operators understand the costs associated with different compliance options. Visit www.lr.org/eca to download your copy.

6.1 SO_x scrubber technologies

Currently there are two main types of SO_x scrubber:

- **wet** scrubbers (section 6.2) that use water (seawater or fresh) as the scrubbing medium; and
- **dry** scrubbers (section 6.7) that use a dry chemical.

Wet systems are further divided into:

- **'open loop'** systems (section 6.3) that use seawater
- **'closed loop'** systems (section 6.4) that use fresh water with the addition of an alkaline chemical; and
- **'hybrid'** systems (section 6.5), which can operate in both open loop and closed loop modes.

Section 6.8 and Table 3 provide a comparison of the different types of SO_x scrubber.

6.2 Wet SO_x scrubbers

Wet SO_x scrubbing is a simple, effective technology that has been used in industrial applications for many years. Wet SO_x scrubbers broadly comprise the following components:

- a scrubber unit – a vessel or series of closely coupled components, which bring water into intimate contact with the exhaust gas from one or more combustion units. The unit is typically mounted high up in the ship in or around the funnel

- a treatment plant for conditioning of washwater before discharge overboard
- a residue handling facility for sludge separated from the washwater
- a scrubber control and emissions monitoring system.

These components will be interconnected by pipework with various pumps, coolers and tanks, depending on the scrubber system configuration. One piping system and washwater treatment plant may service more than one scrubber. There will also be a monitoring and control system, with instrumentation either dedicated to a single scrubber or shared across an integrated system.

Within wet SO_x scrubbers there is a need to intimately mix washwater with the exhaust without creating a backpressure that exceeds the combustion unit manufacturer's limits and, if applicable, the engine's NO_x certification limits. There are, however, incentives to make the scrubber unit as small as possible, as this will reduce the space required for installation and will also reduce manufacturing costs. The design should therefore make optimum use of the minimum practical washwater flow to dissolve sulphur oxides, to bring emissions down to the required level while retaining sufficient buffering capacity. Too little effective flow, mixing or alkalinity and the required reduction in SO_x is not achieved. Conversely, too much water is inefficient in terms of pumping power and component size and weight.

A wet SO_x scrubber system may also include a reheater to increase the exhaust gas temperature above the dew point, and a demister to remove fine water droplets.

Figure 7: Water vapour in an exhaust gas plume after passing through a wet SO_x scrubber (image courtesy of Alfa Laval)

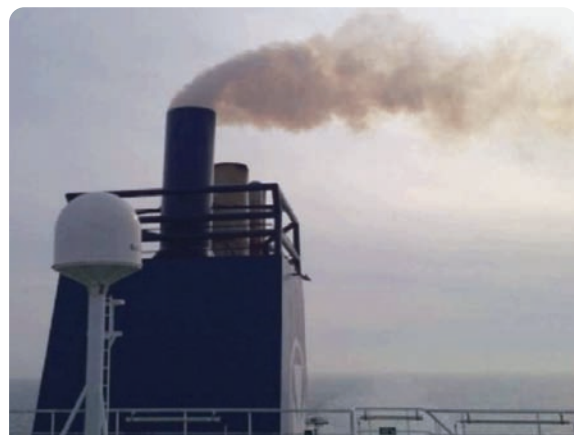

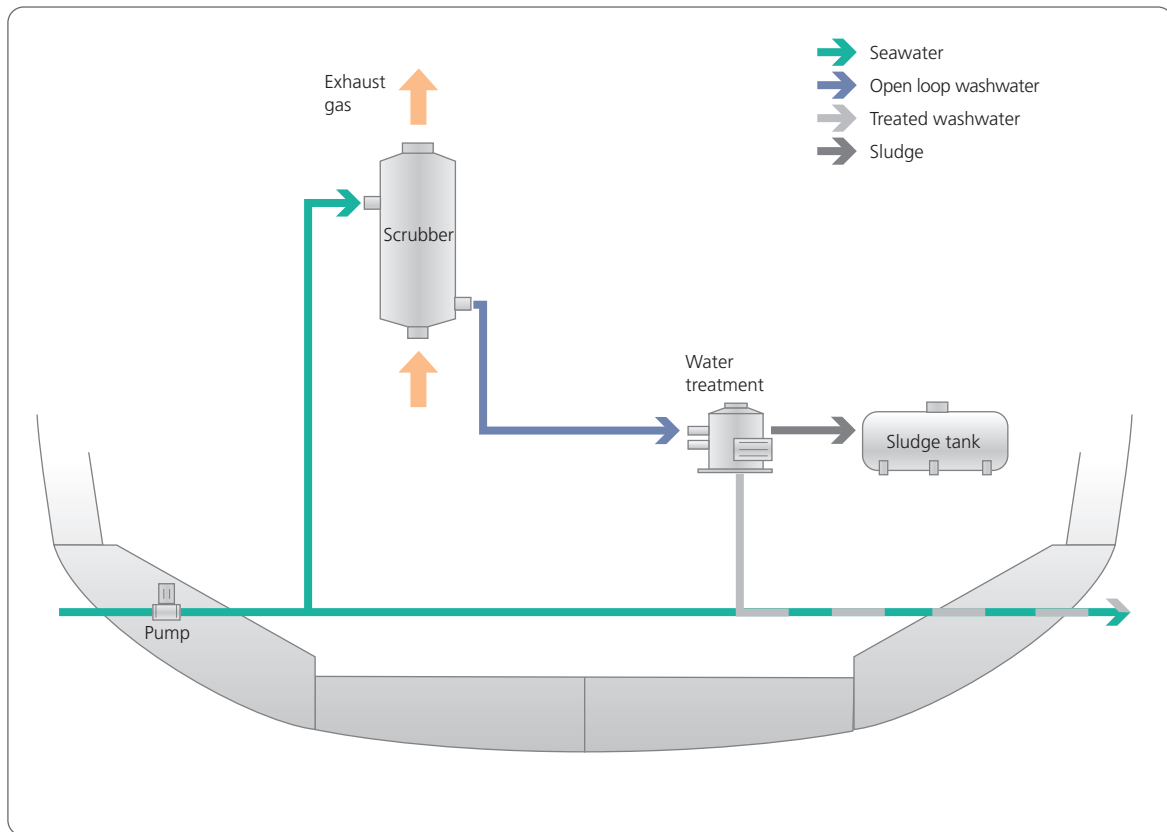

Figure 8: An open loop wet SO_x scrubbing system

6.3 Wet SO_x scrubbers – open loop

In wet open loop SO_x scrubbing systems (including hybrid systems operating in open loop mode – see section 6.5) seawater is pumped from the sea through the scrubber, cleaned (see figure 8) and then discharged back to sea. Washwater is **not** recirculated. The washwater flow rate in open loop systems is approximately 45m³/MWh.

A SO_x removal rate close to 98% with full alkalinity seawater should be expected, meaning emissions from a 3.50% sulphur fuel will be the equivalent of those from a 0.10% sulphur fuel after scrubbing. In the design process seawater temperature also has to be considered as SO₂ solubility reduces at higher seawater temperatures. Equipment manufacturers should provide guidance on the maximum sulphur content of fuel that can be consumed by an engine or boiler with a scrubbed exhaust, so that emissions remain within applicable limits, together with any seawater temperature limitations that may apply.

6.4 Wet SO_x scrubbers – closed loop

All marine closed loop SO_x scrubbers (including hybrid SO_x scrubbers when operating in closed loop mode – see section 6.5) use fresh water treated with sodium hydroxide^c (NaOH) as the scrubbing media. This results in the removal of SO_x from the exhaust gas stream as sodium sulphate. The chemical reactions are shown in Appendix C. Rather than the once-through flow of an open loop scrubber the washwater from a closed loop scrubber passes into a process tank where it is cleaned before being recirculated (see figure 9).

Control of pH by dosing with sodium hydroxide enables the washwater circulation rate and therefore power consumption to be about half that of open loop systems at approximately 20 m³/MWh and between 0.5 – 1% of the power of the engine being scrubbed. Closed loop systems can also be operated when the ship is operating in enclosed waters where the alkalinity would be too low for open loop operation.

^c Also known as caustic soda or lye

SO_x

Open

Closed

Hybrid

Dry

NO_x

SCR

EGR

Case study one

Installation of a Hamworthy-Krystallon open loop scrubber on P&O Ferries' *Pride of Kent*

In 2005, Hamworthy Krystallon Ltd. (HKL) approached P&O Ferries with a request to install and test a prototype scrubber on board *Pride of Kent*. P&O Ferries agreed and in December 2005 a scrubber was installed on a 1MW auxiliary generator. Due to the constraints of *Pride of Kent's* fuel system, and as the scrubber was only cleaning a small proportion of the installed power, it was not used to achieve compliance with regulations and the ship operated the scrubbed generator on compliant heavy fuel oil.

The installation made use of much of the pipework and infrastructure that had been installed for a previous unsuccessful scrubber system, but it still required the removal and realignment of a section of the existing exhaust ducting. The conversion was completed in a couple of days.

The costs of the scrubber and installation were covered by HKL who wanted to test their scrubber on board a ship, and demonstrate to clients that their technology operates successfully in a shipboard environment.

GRE (glass reinforced epoxy) piping had been used for the earlier scrubber installation and was retained for the washwater system due to the corrosive nature of warm, acidic washwater. Originally there were a number of failures of the bonded flanges of the GRE piping when the system was subject to the full operating pressure and flow rate. The re-bonded flanges proved reliable and did not leak.

The ship's staff controlled the scrubber using a touch-screen and a 'green button and red button' (start/stop) approach. In addition to turning the system on and off, ship's staff had to monitor washwater discharge parameters and pressure drop across the scrubber and periodically check the uptake spaces for leakages. When they identified a problem they generally shut down the system and called HKL to make repairs, rather than repairing the system themselves. This was partly due to the developmental nature of the installation, and partly due to the ready availability of the HKL team.

One aspect of the scrubber that evolved during the trial was the 'de-plume' heat exchanger arrangement. The de-plume heat exchanger was fitted after the scrubber chamber to reduce the visible exhaust plume, in conjunction with a de-mister. The initial de-plume design would slowly clog up with deposits of calcium salts resulting in increased backpressure on the engine. The design steadily evolved to prevent this occurrence.

In addition, when the scrubber was operating, ship's staff reported that the exhaust from the scrubbed engine was clearer than that of the other engines, suggesting that there was no carry over of washwater

and that a proportion of the particulate matter within the exhaust was also being removed.

While in port at berth, reaction water in the form of cooling water from auxiliary engines was added to the discharge stream to correct the pH. This was not required when the ship was at sea. Typically the quantity of dilution water was 1.5 times the washwater flow rate.

The multi-cyclones were de-sludged once every 24 hours. While the accumulation of sludge was small (estimated to be approximately 0.14 kg/MW·day) it did depend on the water the ship was operating in and the combustion quality of the engine. It was noted that the amount of sludge increased when operating in Calais where there is increased sand and silt in the harbour water. On *Pride of Kent* the sludge from the generator was combined with the sludge from the fuel oil purifiers and landed ashore, but on subsequent system designs the sludge is stored separately in dedicated IBC tanks that can be taken ashore for disposal.

The *Pride of Kent* scrubber was not fitted with a bypass but operational experience has convinced HKL that a bypass should be offered as an option to enhance the availability of scrubbed engines.

After 30,000 hours of operation during the past six years the scrubber has now been removed. The scrubber worked, achieving the 98% SO_x reduction required to reduce emissions from 3.50% sulphur fuel to the equivalent of 0.10% sulphur fuel.

The design has formed the basis of the HKL scrubbers fitted to all subsequent newbuilds. There is continuing research and development at HKL's test facility in Norway to reduce maintenance requirements and manufacturing costs.

P&O Ferries have learned a lot from the project and have a much better understanding of the challenges associated with the design, installation and operation of scrubbers. They can confidently assess which of their ships are suitable for retrofitting to comply with the forthcoming 0.10% ECA-SO_x limit. ■



Neil Farquhar,
Technical Operations
Manager, P&O Ferries



Lee Bracegirdle,
Marine Technical
Advisor, Hamworthy
Krystallon Ltd.

SO _x
Open
Closed
Hybrid
Dry
NO _x
SCR
EGR

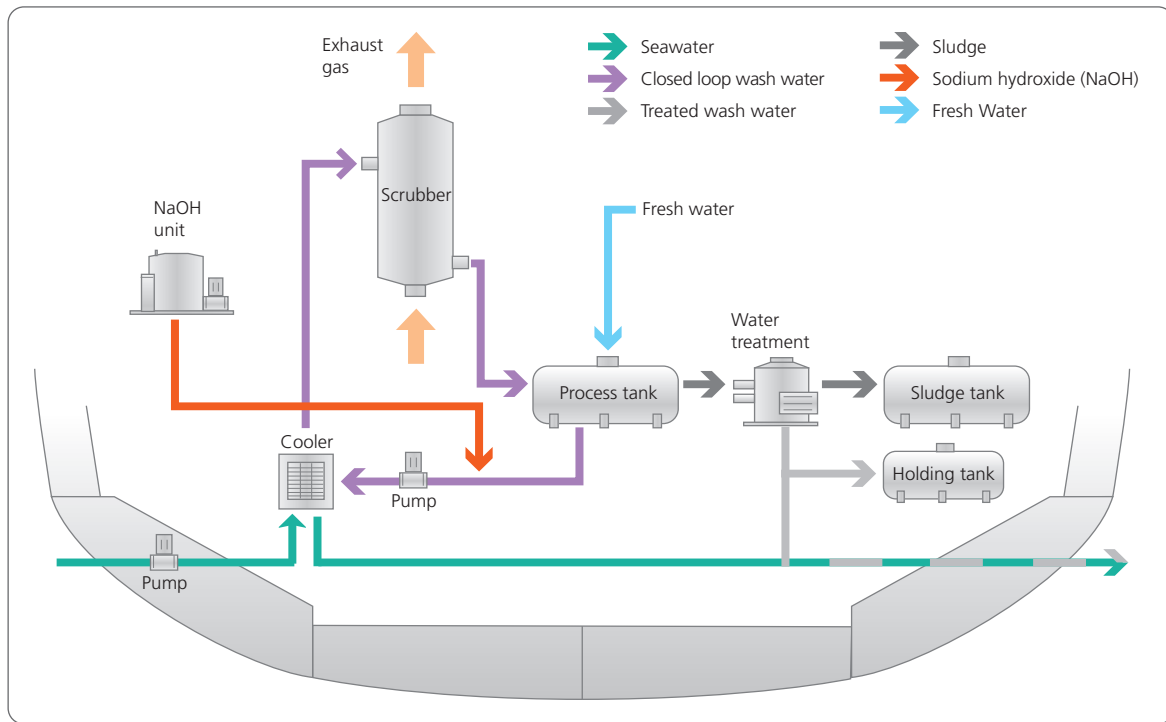

Figure 9: A closed loop wet SO_x scrubbing system

Closed loop systems discharge small quantities of treated washwater to reduce the concentration of sodium sulphate. If uncontrolled, the formation of sodium sulphate crystals will lead to progressive degradation of the washwater system. Information from scrubber manufacturers suggests that the washwater discharge rate is approximately 0.1 m³/MWh.

The rate of fresh water replenishment to the system is not only dependent on the discharge to sea but also losses to the exhaust through evaporation and via the washwater treatment plant. The rate of evaporation is influenced by exhaust and scrubbing water temperatures, which in turn are governed by factors such as engine load and the temperature of the seawater supply to the system coolers. Some of the water vapour incorporated within the exhaust may be captured after the scrubber and reused to reduce fresh water consumption.

With the addition of a washwater holding tank, closed loop systems can operate in zero discharge mode for a period of time (the exact length of time depends on the size of the holding tank). This flexibility is ideally suited to operation in areas where there is sensitivity to washwater discharges, such as ports and estuaries.

By being able to operate in zero discharge mode, closed loop systems also provide a measure of mitigation against washwater discharge regulations that may come into force in the future.

Closed loop systems typically consume sodium hydroxide in a 50% aqueous solution. The dosage rate is approximately 15 litres/MWh of scrubbed engine power if a 2.70% sulphur fuel is scrubbed to equivalent to 0.10%.

The density of 50% sodium hydroxide aqueous solution is 1530 kg/m³ at 15°C and storage tanks must be designed accordingly. The choice of materials for pipework, fittings and tanks is also an important consideration as sodium hydroxide is corrosive to aluminium, brass, bronze, tin, zinc (including galvanised coatings) and glass. Mild steel can experience corrosion cracking at over 50°C; stainless steel is resistant at higher temperatures.

Sodium hydroxide is usually delivered by road tanker at a transportation temperature of around 40°C. The temperature when pumping must be above 20°C, as the viscosity rapidly rises below this temperature. However, it should not be above 50°C to prevent corrosion cracking of mild steel pipework. Onboard storage temperature is therefore between 20°C and 50°C.

If onboard temperature is regulated by cooling water systems then the risk of a heat transfer coil failing (leading to cross contamination of the cooling system with sodium hydroxide) should be recognised. Sodium hydroxide has a pH of 14 and is hazardous. It can cause severe skin burns, respiratory damage and eye injury. Robust procedures are required for handling sodium hydroxide, including use of appropriate personal protective equipment (PPE) if there is risk of exposure. Reference should be made to material safety datasheets (MSDS).

Closed loop systems require more tankage than open loop systems. A process or buffer tank is required in the scrubbing water circulation system, a holding tank is required for zero discharge mode (size dependent on ship requirements) and loading facilities, storage tanks and dosing equipment are required for sodium hydroxide.

6.5 Wet SO_x scrubbers – hybrid

Hybrid systems can be operated in either open loop mode (see section 6.3) or closed loop mode (see section 6.4). This provides the flexibility to operate in closed loop mode (including zero discharge mode) where the water alkalinity is insufficient or where there is sensitivity to, or regulation of, washwater discharge, and in open loop mode without consuming sodium hydroxide at all other times.

The arrangement offers advantages in that sodium hydroxide is only used when necessary, reducing handling and storage and associated costs. Fresh water consumption is also reduced.

Hybrid scrubbers are, however, more complex than open loop or closed loop SO_x scrubbers. Figures 10a and 10b show the layout of a typical hybrid system, in open and closed loop modes.

SO_x

Open

Closed

Hybrid

Dry

NO_x

SCR

EGR

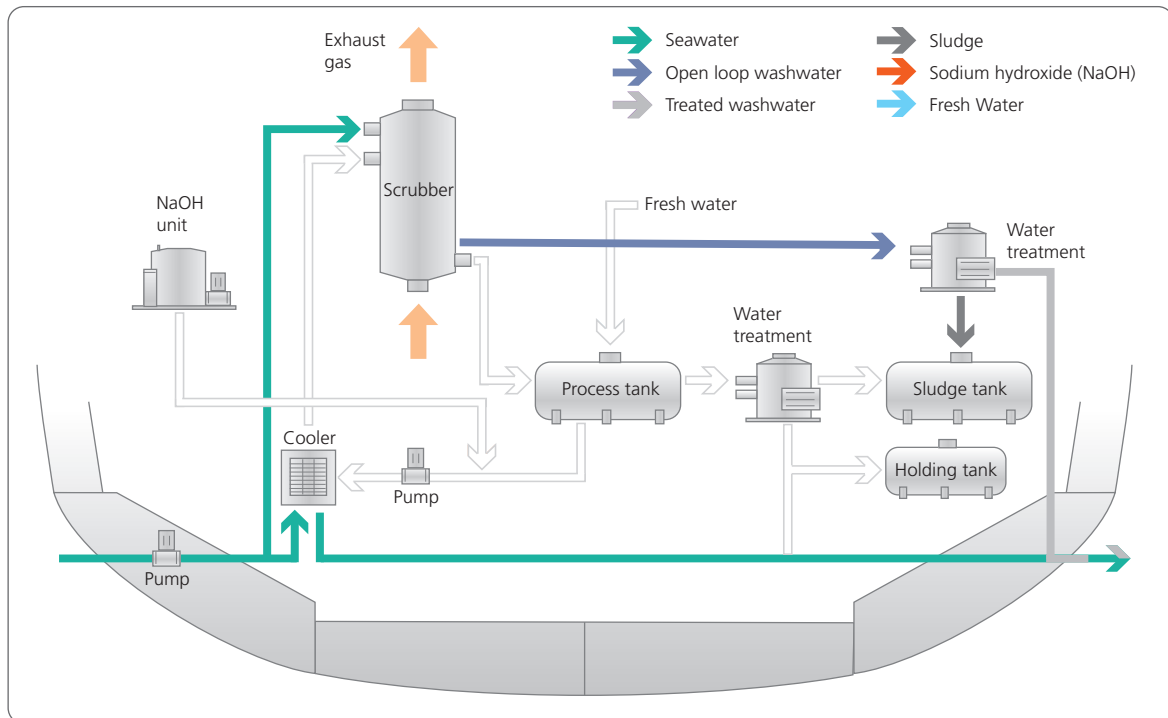

Figure 10a: A hybrid SO_x scrubbing system, operating in open loop mode

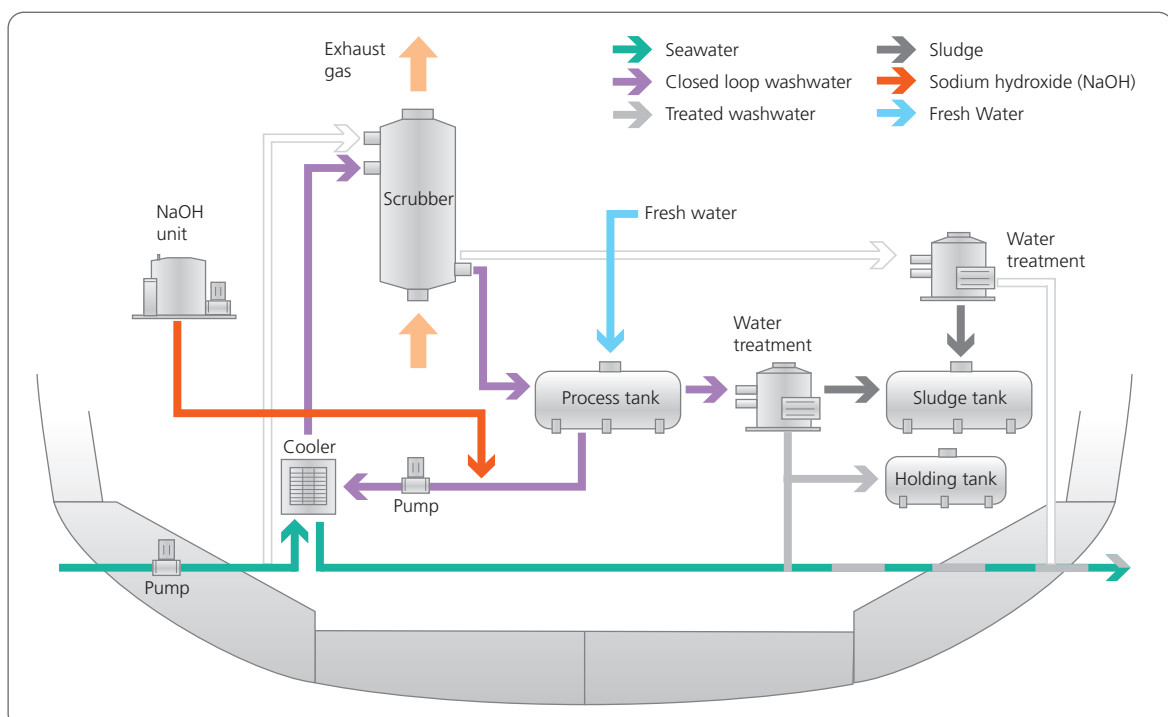

Figure 10b: A hybrid SO_x scrubbing system, operating in closed loop mode

Case Study two

Alfa Laval hybrid scrubber installed on DFDS Ferry *Ficaria Seaways*

In 2008, Alfa Laval approached DFDS to explore the possibility of installing a prototype scrubber on board *Ficaria Seaways*. The ship was an attractive proposition for two main reasons: she operated exclusively within an ECA-SO_x; and she was due to commence an extensive refit.

DFDS and Alfa Laval divided the work between them. Alfa Laval designed the scrubber and oversaw its installation and commissioning, supplying all of the equipment needed for the installation; DFDS oversaw the installation of the supporting systems including pumps, piping and cabling as well as the steelwork modifications associated with the extension of the funnel. Figure 11 shows the scrubber unit during installation.

The scrubber is a hybrid, capable of operating in both open loop and closed loop modes. It includes an exhaust gas bypass to allow the ship to continue to operate at times when the scrubber is being maintained or repaired. When the scrubber bypass is in the open position the ship is operated on compliant fuel.

The washwater system design includes a single 200kW washwater pump which means that the scrubber has to be shut down while the pump is being maintained or repaired. For any future wet scrubber installations DFDS would install three pumps, two of which would be required to operate the scrubber. This would allow operation to continue while one pump is being maintained or repaired.

Throughout the design and installation phases DFDS encouraged the active participation of the staff on board *Ficaria Seaways*. This included temporarily installing washwater piping and asking ship's staff how it could be improved. Based on their feedback the pipework design was revised to reduce pressure drop in the system, improve support arrangements, and minimise impact on the spaces that the piping is routed through.

DFDS have experienced good co-operation from the Lloyd's Register Copenhagen team for the approval of updated plans and manuals. In addition to the standard class approval of piping systems and equipment, the ship's Loading Manual and Stability Manuals have had to be re-approved due to the impact of the scrubber and its associated systems on the ship's lightship weight and vertical centre of gravity. Alfa Laval has also submitted

a risk assessment that identifies the risks associated with the scrubber and any mitigation measures that have been implemented to manage these risks.

As the scrubber was fitted on *Ficaria Seaways* as part of a technology demonstration, the Danish Environmental Protection Agency (EPA) has temporarily permitted the ship to operate on non-compliant heavy fuel oil when the scrubber is operating. Lloyd's Register (acting as a recognised organisation on behalf of the EPA) approved the content and format of the SO_x Emissions Compliance Plan, the Onboard Monitoring Manual and the Technical Manual for Scheme B compliance. Ship's staff will be able to use these documents to demonstrate compliance through continuous monitoring of the exhaust gas and washwater.

The scrubber was initially commissioned in May 2010 and was operational from June 2010 to December 2010. During this time the system suffered from some washwater piping leaks. The leaks occurred due to failure of the coating on the inside of the pipes, which exposed the steel beneath to the warm, acidic, and hence highly corrosive, washwater. These failures occurred in spite of precautions taken to ensure adequate coating thickness by grinding welds on the internal surfaces before the pipes were coated by qualified painters. In December 2010, DFDS took the decision to replace all of the steel piping with GRE piping; at this time the washwater holding tank was also replaced with a GRE tank. The scrubber has been back in action since July 2011 and there have been no leaks from the new pipework. (DFDS did note that GRE piping requires more support and has a larger bend radius than the equivalent in steel.)

For the ship's staff the operation of the scrubber system is straightforward: pressing the green button starts the scrubber and pressing the red button stops the scrubber. The control system uses a feed from the ship's GPS to automatically switch from open loop mode to closed loop mode when entering port and when operating in Swedish waters. (It was agreed with the Swedish maritime





Figure 11: The 21MW hybrid scrubber during installation on *Ficaria Seaways* (image courtesy of Alfa Laval)

authorities that the ship would only operate in closed loop mode while in Swedish waters.) Alfa Laval is happy with this arrangement as it means they get good information on the operation of the scrubber in both open and closed loop modes while in passage. In part due to their early involvement, the staff on board *Ficaria Seaways* took responsibility for the scrubber system soon after it was commissioned and now undertake maintenance and repairs as for any other system on board the ship.

When operating in closed loop mode 50% sodium hydroxide solution is used to control the pH of the recirculating washwater. At this concentration sodium hydroxide is a very hazardous chemical. It is brought on board in 1,000 litre IBC tanks and hoses to the tanks are connected and disconnected manually by ship's staff. DFDS require that the staff wear full protective equipment when handling the chemical. The current storage capacity for sodium hydroxide solution is not sufficient for continuous operation in closed loop mode and DFDS is considering the use of larger tanks for future installations, ideally a dedicated tank integrated into the ship's structure.

In July 2011, the exhaust ducting after the scrubber was altered to increase the velocity of the exhaust gas to ensure that the exhaust plume clears the ship.

A large number of sensors for various parameters including temperature and pressure have been fitted to the scrubber to gather data on its performance. Inevitably there have been some failures and it has been necessary to carry a number of spares. The issue has been exacerbated as the prototype control system does

not make an assessment of the severity of the fault – it simply goes into a failure mode. Production versions of the scrubber not only contain fewer sensors but also a more intelligent fault handling system that responds appropriately to the identified failure event.

When operating in closed loop mode the scrubber system periodically discharges a quantity of washwater to reduce the build up of sulphate. The system is topped up with fresh water and condensed water vapour taken from the exhaust gas after the scrubber, which is reintroduced into the recirculating washwater. Cooling the washwater increases the amount of water vapour that can be condensed.

The Danish EPA has produced a report on the environmental impact of washwater discharges, in part using data based on samples taken from *Ficaria Seaways*. Alfa Laval believes that washwater criteria should be reviewed, and improved as necessary.

Both DFDS and Alfa Laval have learned a lot from the trial installation on board *Ficaria Seaways*. Both are confident that the scrubber technology works. DFDS have a strong understanding of the costs of installing and operating a scrubber and have also been able to apply their understanding to assess which of the other ships in their fleet could be retrofitted with scrubbers. Alfa Laval have used the experience gained from the trial to gather much data, which they now use to precisely design scrubbers for a range of different engine sizes. They have also been able to develop individual components of the system to operate effectively and reliably. ■



Kasper Moos
Vice President,
Technical Organisation
DFDS A/S



Jens Peter Hansen
R&D Manager,
Exhaust Gas Cleaning
Alfa Laval



SO_x

Open

Closed

Hybrid

Dry

NO_x

SCR

EGR



Figure 12: Washwater treatment system with GRE piping (image courtesy of Hamworthy-Krystallon)

6.6 Common aspects of wet SO_x scrubbers

Wet SO_x scrubber system materials

Washwater in wet SO_x scrubbers is highly corrosive and the scrubber components that come into contact with it should be constructed of suitable corrosion-resistant materials. Glass reinforced epoxy (GRE) piping (the black piping shown in figure 12) has been used successfully in a number of installations. GRE piping is lightweight, which makes it easier to handle during retrofits, but its reduced rigidity makes it necessary to install appropriate bracketing – in excess of that required for steel pipe. The relevant LR rules should be followed, e.g., use of steel transition pieces, fitted with suitable closing devices where GRE piping passes through watertight doors. GRE piping close to the scrubber must also be protected from exposure to hot exhaust gases.

Experience indicates that coated steel piping may not be suitable as it can suffer rapid localised corrosion typically at welds and flanges, where there is an increased risk of breakdown of the coating. Stainless steel 316L may also be subject to rapid corrosion, particularly in open loop systems using seawater, which has a moderately high

temperature after scrubbing and a low pH. In these cases, nickel alloys with a higher pitting resistance equivalence number (PREN) may be used.

Typically, it is not necessary to change the materials of the exhaust duct and systems downstream of a wet SO_x scrubber if the exhaust gas temperature is kept above the dew point. If this is not the case, corrosion-resistant materials should be used.

During the class unit approval and the ship-specific class approval (see section 5.2) the materials used in the construction of the SO_x scrubber and its associated systems, including chemical storage and handling systems, will be reviewed for compliance with class Rules.

Washwater treatment plant

The technology and techniques used for washwater treatment are influenced by the overboard discharge rate. The low discharge rate of closed loop systems (0.1 m³/MWh) enables use of centrifugal separators (similar to those used for fuel and lubricating oil) or multi-stage oily water separators. Wärtsilä's washwater treatment plant (shown in figure 13) is an example of the latter.

Figure 13: Multi-stage washwater treatment system used with closed loop SO_x scrubbers (image courtesy of Wärtsilä)





For open loop systems with a higher discharge rate ($\approx 45 \text{ m}^3/\text{MWh}$), cyclonic separation is appropriate. This technique is widely used in onshore and offshore industry and may also be encountered in ships' ballast water treatment systems.

The heavy fractions are moved outward and downward to the outlet (underflow) at the bottom of the device. The light fractions move toward the central axis and upward to the outlet (overflow) at the top of the device. A hydrocyclone is a tapered device that converts velocity of a liquid into a rotary motion. It does this by means of a tangential inlet or inlets near its top. This causes the entire contents to spin, creating centrifugal force in the liquid.

Hydrocyclones can either consist of a single vessel or a 'nest' of hydrocyclone 'liners' within a vessel (see figure 14). The latter, which may be either horizontally or vertically orientated, is arranged with a plate (similar to a tube plate in a cooler) at each end. The overflow plate holds the overflow end of each liner in place while the underflow plate holds the underflow ends.

Stage	Process/technique
Stage 1	Using dissolved air, oil contained within the washwater is floated to the surface, where it is skimmed off.
Stage 2	Suspended particulate matter is removed using coagulation and flocculation processes. Coagulants are used to neutralise negative charges, causing particles to repel each other so that they are unable to agglomerate. Flocculent then combines the neutrally charged particles into larger masses.
Stage 3	Dissolved air flotation is again used to separate and remove particles from the washwater.
Stage 4	Before discharge, the washwater is finally subjected to active carbon filtration. The carbon has a very high surface area because of its micro-porosity and is effective at removal of organic compounds, including PAHs by adsorption.

Table 2: Typical stages in a closed loop washwater treatment system

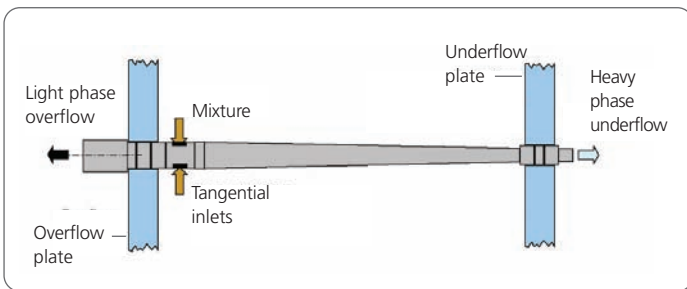

Figure 14: Hydrocyclone liner

Depending on design, hydrocyclones can separate solids from liquid or liquids of differing densities. Combinations can therefore be used to separate both particulate matter and hydrocarbons from washwater. The velocity of the washwater is either imparted by a pump or by the height of the scrubber above the washwater plant in the engine room, if sufficient.

In US submissions to the IMO supporting the introduction of the North American ECA^[7], test data showed PM₁₀ emissions being dependent on fuel sulphur levels, with emission rates of 0.23 g/kWh with distillate fuel (0.24% sulphur content) and 1.35 g/kWh with residual fuel (2.46% sulphur content) – which accorded well with the findings of LR’s Marine Exhaust Emissions Research Programme^[1].

If a scrubber removes 70% of the particulate matter, then approximately 500kg of sludge may be expected for every 100 tonnes (t) of residual fuel consumed by a diesel engine. This is dependent on removal rate at the scrubber and the efficiency of the washwater treatment, both in removing PM and not including excess water. Wet SO_x scrubber manufacturers typically recommend a sludge tank of around 0.5m³/MW of scrubbed engine power.

Residue removed from SO_x scrubber washwater must be stored on board, landed ashore and disposed of appropriately; it is not permitted to incinerate it or discharge it to sea.

Washwater discharges

Figure 15 shows the position of instruments that can be fitted to an open loop system for the monitoring of water quality at system inlet and overboard discharge. The IMO Exhaust Gas Cleaning System Guidelines require the following to be continuously monitored for comparison with the quality of the receiving waters:

- pH as a measure of acidity
- polycyclic aromatic hydrocarbons (PAHs) as a measure of harmful oil components
- turbidity as a measure of particulate content.

A salinity meter may also be fitted at the system supply as the IMO Exhaust Gas Cleaning Systems Guidelines require details of the “minimum inlet water alkalinity” and “salinity levels or fresh water elements necessary to provide adequate neutralizing agents” to be recorded in the SO_x scrubber’s Technical Manual (ETM-A or ETM-B) – see Appendix B1.

Continuous monitoring of alkalinity is not practical on board ship, but pH and salinity can be used as an indirect reference. Seawater usually has a pH of between 8 and 8.4 so a low salinity and/or pH would suggest entry to brackish water and therefore the potential for loss of scrubbing efficiency. It should be noted that even fresh water may have sufficient buffering capacity for scrubbing, although SO_x removal efficiency can be reduced. Continuous monitoring of washwater will therefore give assurance that the system is able to function when operating in enclosed waters.

In addition to PAH monitoring, a 15 ppm oil-in-water monitor (of the type normally associated with bilge water separation) may be fitted at the system discharge as a further confirmation of the quality of the discharged washwater.

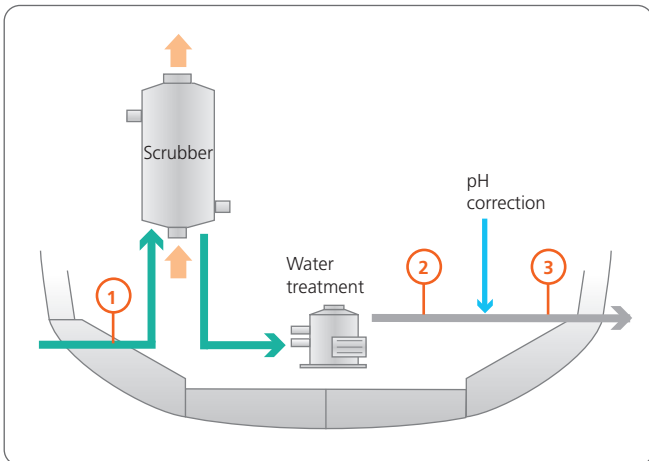

Figure 15: Wastewater instrumentation

Typical wastewater instrumentation is shown in figure 15 and includes:

Point 1 wastewater system inlet

- pH (optional; depending on which method is chosen to determine pH at discharge – see Appendix B1.4)
- PAH
- turbidity
- salinity (optional)

Point 2 (after wastewater treatment plant and before any pH correction)

- PAH
- turbidity

Point 3 (before discharge after any pH correction)

- pH.

If chemicals are added or created in the system to treat wastewater, the IMO Exhaust Gas Cleaning System Guidelines require a specific assessment of the effect of those chemicals on the quality of the discharged wastewater. The SO_x scrubber manufacturer will have to provide details of any parameters to be monitored that are additional to those specifically listed in the Guidelines.

The position, care, calibration and survey requirements for wastewater monitoring instruments must be contained within an approved Onboard Monitoring Manual (OMM). Further information is included in Appendix B1. Short periods of instrument downtime are allowed for maintenance and cleaning but only when the ship is not in ports, harbours or estuaries. This may have commercial implications if there are tasks that have to be undertaken at sea requiring attendance by the manufacturer or specialists.

The IMO Exhaust Gas Cleaning Systems Guidelines state the wastewater discharge criteria are intended to act as initial guidance and that as more data becomes available the criteria should be revised, taking into account any advice given by GESAMP^d. Ship operators, in conjunction with the scrubber manufacturer, are requested to analyse a minimum of three sets of samples of system inlet water, wastewater before treatment and wastewater discharge over a two year period. Analysis should include pH, PAH, oil, nitrate, nitrite and metal content, although the tests can be varied as knowledge develops. Analysis data, together with relevant scrubbing system and engine operating parameters, are then to be forwarded by the ship's flag administration to the IMO.

Information on national and local restrictions on wastewater discharges that might apply on a ship's trading pattern can be obtained from the relevant authorities. Any controls are likely to apply to restricted waters rather than open water. Closed loop SO_x scrubbers (and hybrid SO_x scrubbers in closed loop mode) mitigate the effect of wastewater restrictions, as they are able to operate for a period of time in zero discharge mode. Wastewater restrictions are not applicable to dry SO_x scrubbers.

A key compliance requirement already in place is the US Environmental Protection Agency's (EPA) Vessel General Permit (VGP) for discharges incidental to the normal operation of ships. Ship's with exhaust gas cleaning systems must have a VGP in order to discharge SO_x scrubber wastewater. Wastewater must not contain oil, including oily mixtures in quantities that may be harmful as defined by MARPOL Annex I – i.e., the discharge must comply with the 15ppm oil-in-water limit^[19]. Sludge generated from scrubbing must not be discharged to sea. The EPA also recommends that ships follow the wastewater criteria set out in section 10 of the IMO Exhaust Gas Cleaning Systems Guidelines. The permit is applicable to "waters of the United States, including the contiguous zone or ocean". The EPA is planning to introduce a revised VGP in 2013.

^d GESAMP - Joint Group of Experts on the Scientific Aspects of Marine Environmental Protection – an advisory body to the UN (see www.gesamp.org)

SO_x

Open

Closed

Hybrid

Dry

NO_x

SCR

EGR

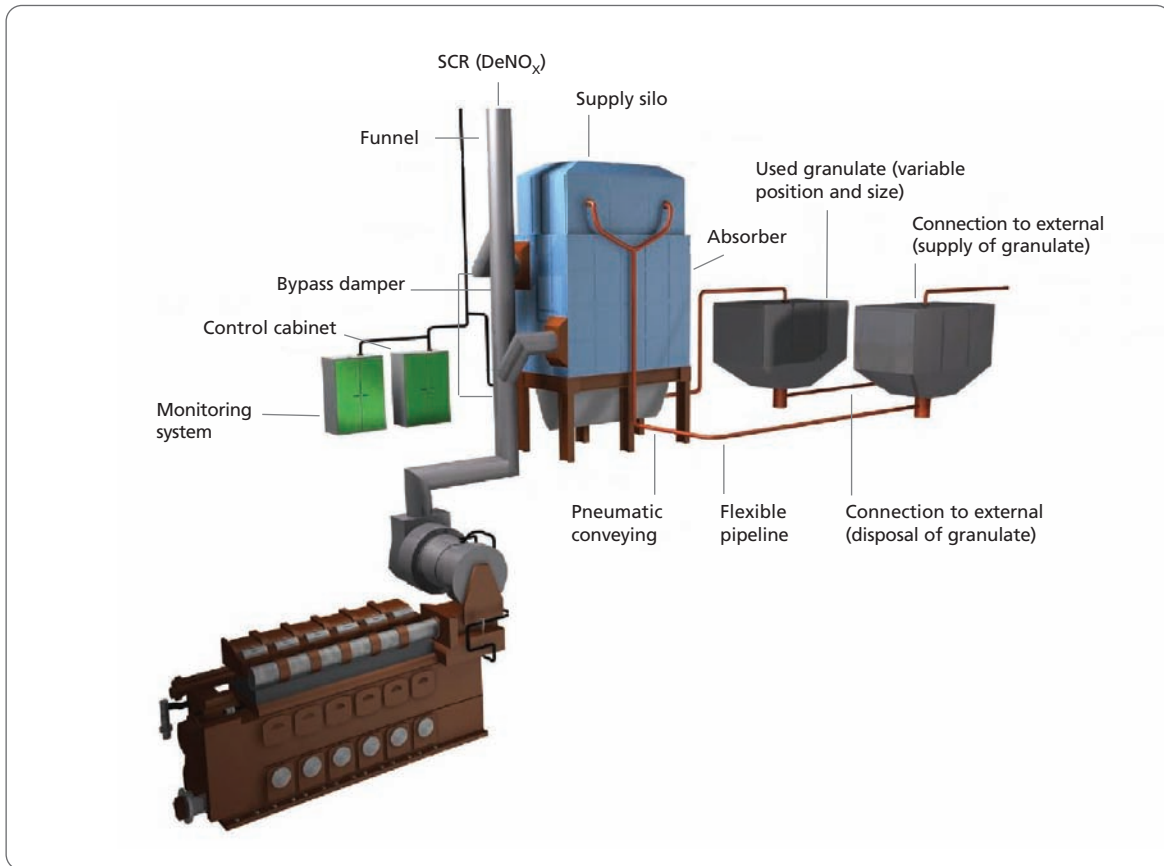

Figure 16: A dry SO_x scrubber system (image courtesy of Couple Systems)

6.7 Dry SO_x scrubbers

Dry SO_x scrubbers have been widely used in land-based industry since the 1970s. Figure 16 shows a typical dry SO_x scrubber comprising the following main components:

- **A scrubber unit**, in this case known as an 'absorber', which brings the exhaust gas from one or more combustion units into contact with calcium hydroxide granules^e. Unlike the majority of wet scrubbers, the exhaust gas entry is perpendicular to the vertical downward flow of the scrubbing medium. No heat is removed from the exhaust gas during scrubbing (in fact the reaction is exothermic and releases heat) so dry scrubbers can be positioned before waste heat recovery and SCR equipment.
- **A granule supply silo and screw conveyor** for discharge, positioned at the top and bottom of the absorber respectively. A pneumatic conveyor system enables granules to be transported from and returned to onboard storage facilities. The use of flexible pipework facilitates the storage of granules at various locations on board.

- **A scrubber control and emission monitoring system**. Removal of the used granules and any exhaust-related particulate matter is an automated process and may either be continuous or intermittent to ensure the correct flow of fresh granules under gravity down through the absorber.

Dry scrubbers typically operate at exhaust temperatures between 240°C and 450°C. Calcium hydroxide granules are between 2 and 8 mm in diameter (see figure 17) with a very high surface area to maximise contact with the exhaust gas. Within the absorber, the calcium hydroxide granules (Ca(OH)₂) react with sulphur oxides to form gypsum (CaSO₄·2H₂O). Details of the chemical reactions can be found in Appendix C1.3. Trials on a 3.6MW engine using up to 1.80% sulphur content fuel are reported to show a 99% and 80% reduction in SO₂ and particulate matter emissions respectively. It should be noted that the PM reduction was tested according to DIN51402 (rather than either of the methods mentioned in section 6.8) whereby particulate is captured on a filter of silica fibre material.

^e Also known as slaked lime

The filter is then assessed either visually or by photometer, which compares the intensity of reflected light with that from the original light source, enabling a smoke number to be derived by a standard conversion procedure.

To reduce SO_x emissions to those equivalent to fuel with a 0.10% sulphur content, a typical marine engine using residual fuel with a 2.70% sulphur content would consume calcium hydroxide granules at a rate of 40 kg/MWh and, based on a density of 800kg/m^3 , the volume of granulate required would be approximately $0.05\text{ m}^3/\text{MWh}$ (i.e., a 20MW engine would require approximately 19 tonnes of granulate per day with a volume of 24m^3). Electrical power consumption is lower than for wet systems at approximately 0.15 – 0.20% of the power of the engine being scrubbed.

Unlike wet scrubbers, dry scrubbers have no requirement for washwater treatment systems and their associated pipework, tankage, instrumentation and controls. This simplifies installation and operation, and makes dry scrubbers ideally suited to areas where there is increased sensitivity regarding discharges to sea. However, as with closed loop operation of a wet system, there is a need for storage and handling of consumables. Used granules must also be stored before disposal ashore.

The scrubber manufacturer can co-ordinate the logistics of supplying, removing and disposing of granulate.

Fresh granules can be supplied to the ship by silo road tankers fitted with pneumatic delivery systems or in 'Big Bags' to smaller ships (although this is not a preferred method). Strategic logistics centres are also planned for the delivery and reception of new and used granules in special 15 tonne containers. These can be handled in the same manner as standard shipping containers and located at convenient positions on board. Each container is divided into compartments so it can store both fresh and used granules.

Calcium hydroxide is a strong alkali and appropriate care should be taken when handling it on board, with reference to material safety datasheets (MSDS).

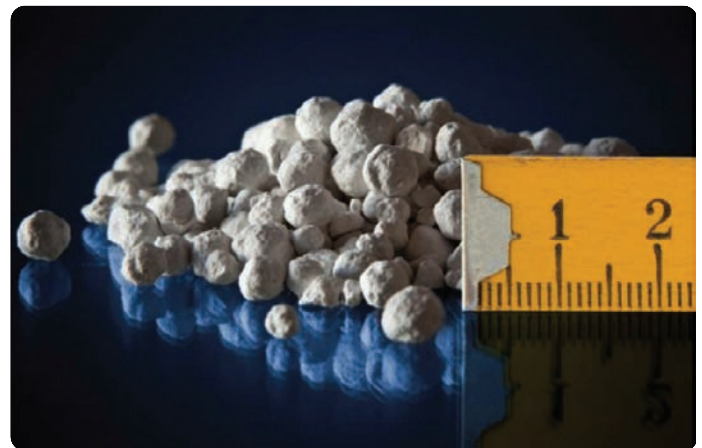

Figure 17: Calcium hydroxide granules (image courtesy of Couple Systems)

The chemical is classed as harmful to eye and skin and the inhalation of dust should be avoided. Although calcium hydroxide has hazardous properties, it is considerably less hazardous than 50% aqueous sodium hydroxide solutions typically used in wet scrubbing systems. It should be kept dry and away from contact with acids. It is also important that used granules remain dry, and fully contained storage and handling systems are therefore an advantage. If a ship's own storage is used, advice should be taken as to appropriate alkali-resistant coatings.

While dry scrubbing does not reduce NO_x emissions by itself, it is ideally suited for use in conjunction with SCR systems (see section 7.1) which require hot exhaust gas to attain an operating temperature of above 300°C and SO_x concentrations less than those of a fuel with a 1.0% sulphur content. Higher sulphur fuels ($> 1.0\%$) can lead to plugging of the SCR catalyst, which diminishes NO_x reduction efficiency and potentially shortens the life of the catalyst.

An optional downstream fan can be fitted so that the engine is not subject to excessive backpressure and the complete arrangement can be bypassed.

SO_x

Open

Closed

Hybrid

Dry

NO_x

SCR

EGR

6.8 Comparing SO_x scrubber technologies

Operation in fresh water

Alkalinity or the buffering capacity of seawater is a key parameter for the effective operation of wet open loop SO_x scrubbers (including hybrid SO_x scrubbers when operating in open loop mode). When exhaust gas is mixed with seawater inside the scrubber, sulphur oxides are dissolved, increasing the acidity and lowering the pH of the washwater. Alkalinity is a measure of the ability to resist changes in pH; in seawater, alkalinity is naturally provided by bicarbonates, carbonates, borates and anions of other 'salts' in more minor quantities. Details of the chemical reactions can be found in Appendix C. It is not the sodium chloride content of seawater that facilitates scrubbing. Hence, salinity (a measure of all salts present) only indirectly indicates that sufficient alkalinity is present.

Some natural fresh water can be highly alkaline and suitable for scrubbing, although efficiency may be reduced. The water in the Great Lakes and areas within the Baltic Sea does not have sufficient alkalinity to support the operation of wet, open loop SO_x scrubbers. Closed loop wet SO_x scrubbers (including hybrid SO_x scrubbers operating in closed loop mode) and dry SO_x scrubbers do not use seawater as their scrubbing medium; therefore they are unaffected by the properties of the water the ship is operating in.

Operation without discharge to sea

The high washwater discharge rate ($\approx 45\text{m}^3/\text{MWh}$) of open loop systems (and hybrid systems in open loop mode) means that when operating they have to discharge washwater into the sea continuously. The much lower discharge rate ($0.1\text{m}^3/\text{MWh}$) of closed loop systems (and hybrid systems operating in closed loop mode) means that it is possible to retain washwater to be discharged on board for a limited period of time (i.e., operate in zero discharge mode). Dry SO_x scrubbers have no discharges to sea.

Being able to operate in zero discharge mode is ideal for areas where there is sensitivity to wash water discharges, such as ports and estuaries. In addition, while many authorities may be expected to accept washwater discharges meeting the requirements of the IMO Exhaust Gas Cleaning System Guidelines (see section 6.6 and Appendix B1), regional, national and

local regulators may decide to impose a stricter regime for ships operating within their coastal waters. Being able to operate closed loop systems in zero discharge mode for a limited period provides a measure of protection against the possibility of future washwater discharge regulations. Dry SO_x scrubbers are unaffected by washwater discharge requirements.

Weight

The filled dry SO_x scrubber unit for a 20 MW engine is heavier (≈ 200 tonnes) than comparable exhaust capacity wet scrubbers (30-55 tonnes). However, the overall weight of wet and dry systems may be similar once the washwater systems, such as the processing tank, holding tank and chemical storage, are taken into account.

As most of the weight of the dry scrubber system is installed relatively high up in the ship, the impact of the system on the vertical centre of gravity (VCG) of the ship is likely to be greater than for wet SO_x scrubbers, where many of the components may be lower down. When installing a SO_x scrubber on an existing ship, the resulting change in lightship weight and/or VCG may necessitate the revision of the ship's stability manuals.

Power consumption

The washwater flow rate in an open loop SO_x scrubber is higher ($\approx 45\text{m}^3/\text{MWh}$) than a closed loop SO_x scrubber ($\approx 20\text{m}^3/\text{MWh}$) because the buffering capacity of seawater is less than the buffering capacity of fresh water dosed with sodium hydroxide. Consequently, open loop SO_x scrubbers require larger pumps and have higher power requirements.

The power requirement of dry SO_x scrubber systems is mainly associated with a screw conveyor that moves the calcium hydroxide granules through the scrubber unit (known as an absorber). The power required is therefore significantly less than for wet SO_x scrubbers.

The energy consumption associated with SO_x scrubbers does not adversely impact a ship's attained Energy Efficiency Design Index (EEDI) value as, for almost all conventional cargo ships, the auxiliary power consumption will be calculated as a fixed proportion of the installed main engine power, and is unrelated to the actual auxiliary power consumption. However, if the installation of the system reduces cargo carrying capacity then the EEDI will be affected.

	Wet scrubber, open loop	Wet scrubber, closed loop	Wet scrubber, hybrid	Dry scrubber
Main system components	<ul style="list-style-type: none"> •Scrubber •Washwater piping •Washwater pumps •Washwater treatment equipment •Sludge handling equipment 	<ul style="list-style-type: none"> •Scrubber •Washwater piping •Washwater pumps •Washwater processing tank •Washwater holding tank •Sodium hydroxide storage tank •Washwater treatment equipment •Sludge handling equipment 	<ul style="list-style-type: none"> •Scrubber •Washwater piping •Washwater pumps •Washwater processing tank •Washwater holding tank •Sodium hydroxide storage tank •Washwater treatment equipment •Sludge handling equipment 	<ul style="list-style-type: none"> •Absorber •Fresh granulate hopper •Used granulate hopper •Granulate transport system •Additional granulate storage (new and used granules)
Operation in fresh water	X	✓	✓ (Only when operating in closed loop mode)	✓
Operation without discharge to sea	No	For a limited time depending on the size of the washwater holding tank	For a limited time depending on the size of the washwater holding tank	Yes
Weight Typical values for a 20MW SO_x scrubber	30-55t (Excluding washwater system and treatment equipment)	30-55t (Excluding washwater system, treatment equipment, washwater processing tank and washwater holding tank)	30-55t (Excluding washwater system, treatment equipment, washwater processing tank and washwater holding tank)	≈200t (Including granules stored adjacent to the absorber but excluding additional granulate storage)
Power consumption (% of max. scrubbed engine power)	1-2%	0.5-1%	0.5-2% (Depending on whether it is operating in open or closed loop mode)	0.15-0.20%
Scrubbing Chemical consumable	No consumable	Sodium hydroxide solution (≈6 l/MWh-%S)	Sodium hydroxide solution (Only when operating in closed loop mode) (≈6 l/MWh-%S)	Calcium hydroxide granules (≈10 kg/MWh-%S)
Compatibility with waste heat recovery system	Yes, provided the scrubber is installed after the waste heat recovery system	Yes, provided the scrubber is installed after the waste heat recovery system	Yes, provided the scrubber is installed after the waste heat recovery system	Yes. Can be placed before or after the waste heat recovery system
Compatibility with SCR system	No, unless a reheater is fitted after the wet scrubber to raise the exhaust gas temperature	No, unless a reheater is fitted after the wet scrubber to raise the exhaust gas temperature	No, unless a reheater is fitted after the wet scrubber to raise the exhaust gas temperature	✓
Compatibility with EGR system	✓	✓	✓	✓
Particulate matter removal	✓	✓	✓	✓

 Table 3: Comparison of SO_x scrubber technologies

The energy consumption will affect any operational energy efficiency key performance indicators (KPIs) that include actual energy consumption of auxiliary systems, such as the Energy Efficiency Operational Indicator (EEOI).

Compatibility with waste heat recovery units and SCR systems

All wet SO_x scrubbers significantly cool the exhaust gas and are therefore not suitable for installation before a waste heat recovery unit. For the same reason, it would not be possible to install a wet SO_x scrubber before an SCR system (see section 7.1) unless a reheater was fitted after the wet scrubber to raise the exhaust gas temperature back up to around 300°C – the temperature required for SCR systems to work effectively.

Dry SO_x scrubbers do not cool the exhaust gas so they are suitable for installation before both waste heat recovery units and SCR systems.

Particulate matter (PM) removal

SO_x scrubbers can be an effective means of reducing PM (see section A1.5 in Appendix A1), both indirectly by removal of SO_x and by direct mechanical cleaning when particles come into direct contact with either washwater or chemical granules. SO_x scrubber manufacturers typically claim between 70% and 90% removal rates.

The sulphates, which make a significant contribution to PM, are formed post-combustion in the exhaust plume. Oxidation of SO₂, followed by further oxidation and condensation processes, contributes to the growth of complex particles after the cylinder^[4] and the majority of sulphates form in reactions after release from the stack^[5].



A ferry operating in the Baltic ECA-SO_x

The IMO Exhaust Gas Cleaning System Guidelines require monitoring of the SO₂ to CO₂ ratio in the exhaust gas but do not require PM monitoring as this is not necessary to demonstrate equivalence with fuel sulphur content limit. The in-service measurement of particulate matter can be challenging; methods involving weighing deposits on filters are difficult to measure continuously on board.

Ship operators should note that the 'wet' method for collecting PM on filters contained in ISO 8178^f includes sulphates and any incompletely burned hydrocarbons, whereas the 'hot/dry' technique contained in ISO 9096^g does not. Significantly different results will therefore be obtained from the same engine operating under the same conditions consuming the same fuel, with ISO 8178 tests reporting a greater mass of particulate. Scrubber manufacturers have used differing methodologies during their trials, which make it difficult to compare like for like the PM reduction performance of various scrubbers.

Visible smoke

Smoke is a collection of airborne solid and liquid particulates and gases, together with entrained air. Visible smoke from combustion devices on ships is largely comprised of black carbon, heavy metals from the ash content, and water vapour.

Some countries impose 'smoke' control measures on shipping in their coastal waters. For example, within three miles of the Alaska coastline, visible emissions, excluding condensed water vapour, must not reduce visibility through the exhaust of a marine vessel by more than 20 percent. Short defined periods of increased emissions are, however, permitted in port, at anchor or when manoeuvring^[6]. A visible plume may also be undesirable for commercial reasons.

All SO_x scrubbers reduce the black carbon and ash from the exhaust (see section 6.8 – particulate matter removal). But wet SO_x scrubbers may increase the water vapour content in the exhaust stream, resulting in a highly visible white plume unless the exhaust is kept well above the dew point (see figure 5). Wet SO_x scrubber manufacturers should provide guidance on how this will be controlled.

Attenuation of engine noise

SO_x scrubbers are commonly installed in the place of the silencer when converting existing ships. Equipment manufacturers have differing views on the attenuation that their equipment might provide. For wet SO_x scrubbers this attenuation will change depending on whether or not the SO_x scrubber is in operation.

^f the international standard for reciprocating internal combustion engines – exhaust emission measurement

^g the international standard for stationary source emissions – manual determination of mass concentration of particulate matter

7. NO_x-reducing devices

SO_x

Open

Closed

Hybrid

Dry

NO_x

SCR

EGR

NO_x is the collective term for nitric oxide (NO) and nitrogen dioxide (NO₂) emissions. (Nitrous oxide (N₂O) is not a NO_x.) Nitric oxide is a precursor for nitrogen dioxide; approximately 5% NO is oxidised to NO₂ in the exhaust after leaving the cylinder. The major component of NO_x on exit from the ship is nitric oxide, which readily oxidises in the atmosphere.

Nitric oxide is formed in the cylinder during combustion by two main mechanisms.

- Thermal NO(x)
- Fuel NO(x)

Thermal formation is the principal mechanism by which nitric oxide is produced. Fuel NO(x), formed from nitrogen containing fuels, can also be a significant contributor to the total. The proportion attributable to each mechanism depends on the combustion conditions, which in turn are determined by the combustion unit type, configuration and operation, together with the fuel's grade and composition.

Thermal NO(x) is primarily formed in high temperature reactions between nitrogen and oxygen in the charge air. Formation is dependent on temperature, exposure time of the combustion gases to high temperature, and available oxygen. Above 1,500°C the rate of formation rises exponentially.

Fuel NO(x) is formed from the oxidation of the nitrogen compounds predominantly contained in residual fuel oils and biofuels. The process is dependent on the air fuel ratio (i.e., available oxygen) and the quantity of fuel-bound nitrogen and, to a lesser extent, combustion temperature and the nature of the nitrogen compounds.

As the largest component of NO_x is formed through the Thermal NO(x) mechanism, it is not possible to effectively reduce NO_x emissions by controlling the fuel consumed. NO_x reduction is therefore achieved by reducing thermal NO(x) by one of the following:

- primary NO_x control, which reduces the formation of thermal NO(x); and
- post-combustion abatement in which the exhaust gas is treated to remove NO_x.

Primary NO_x control aims to reduce the formation of nitric oxide at source (i.e., in the engine's cylinders). This can be achieved through engine design and by operational adjustments of parameters and components such as fuel injection (pressure, timing, rate, nozzle configuration), valve timing, charge air (temperature, pressure) and compression ratio. The engine builder is however presented with a challenge as there is also a need to minimise fuel consumption, and hence CO₂ emissions, by maximising combustion efficiency. Increasing efficiency typically increases combustion temperature, which has the undesirable effect of increasing NO_x emissions. Using primary controls therefore results in a trade-off between fuel consumption and NO_x emission performance.

Other at-engine measures can enable further reductions of NO at source by reducing local temperatures and oxygen content in the combustion zone. These include various 'wet' technologies, such as: water-in-fuel (WIF); fuel water emulsion (FWE); direct water injection to the combustion space (DWI); water sprays into the charge air (humid air motor (HAM)); and scavenging air moistening (SAM)).

Tier II limits under MARPOL Annex VI, Regulation 13 (see section 3.1) can be achieved using primary controls, with compliance being managed by the engine builder. However, with conventional petroleum-based fuel oils, it appears that Tier III limits are only likely to be achieved using either selective catalytic reduction or exhaust gas recirculation.

Subject to an imminent IMO review of available technologies, Tier III NO_x limits will apply to all ships constructed on or after 1 January, 2016, with engines over 130kW that operate inside an ECA-NO_x. Unlike the sulphur limits in Regulation 14 of MARPOL Annex VI, the Tier III NO_x limits will not retrospectively apply to ships constructed before 1 January, 2016 (except in the case of additional or non-identical replacement engines installed on or after 1 January, 2016).

SO_x

Open

Closed

Hybrid

Dry

NO_x

SCR

EGR

7.1 Selective catalytic reduction (SCR)

Selective catalytic reduction is a relatively mature technology, widely used for NO_x control in land-based industry and land-based transportation. SCR can reduce NO_x emissions by 80-90% to below 2g/kWh. SCR systems are currently fitted to four-stroke medium-speed engines on a number of ships in service which are able to gain commercial advantage from reduced NO_x emissions.

The SCR system converts nitrogen oxides into nitrogen and water, by means of a reducing agent injected into the engine exhaust stream before a catalyst. Urea is the reductant typically used for marine applications. It decomposes to form ammonia in a mixing duct before adsorption onto the catalyst that facilitates the reduction process. Details of the chemical reactions can be found in Appendix C2.1.

An SCR system comprises the following main components:

- a pumping unit for transfer of urea solution from storage
- a urea dosing unit
- a mixing duct with urea injection point
- a reactor housing containing replaceable catalyst blocks
- a control system
- a soot/ash cleaning system.

SCR systems also offer ship-operators a potential fuel saving benefit when operating outside an ECA-NO_x, as it is possible to use the SCR to meet Tier II NO_x limits. This would allow the engine settings to be adjusted for optimum efficiency (Tier II engines are typically 4 – 4.5% less efficient than Tier I engines), resulting in reduced

Figure 18: Marine SCR arrangement – four-stroke medium-speed engine (image courtesy of Wärtsilä)

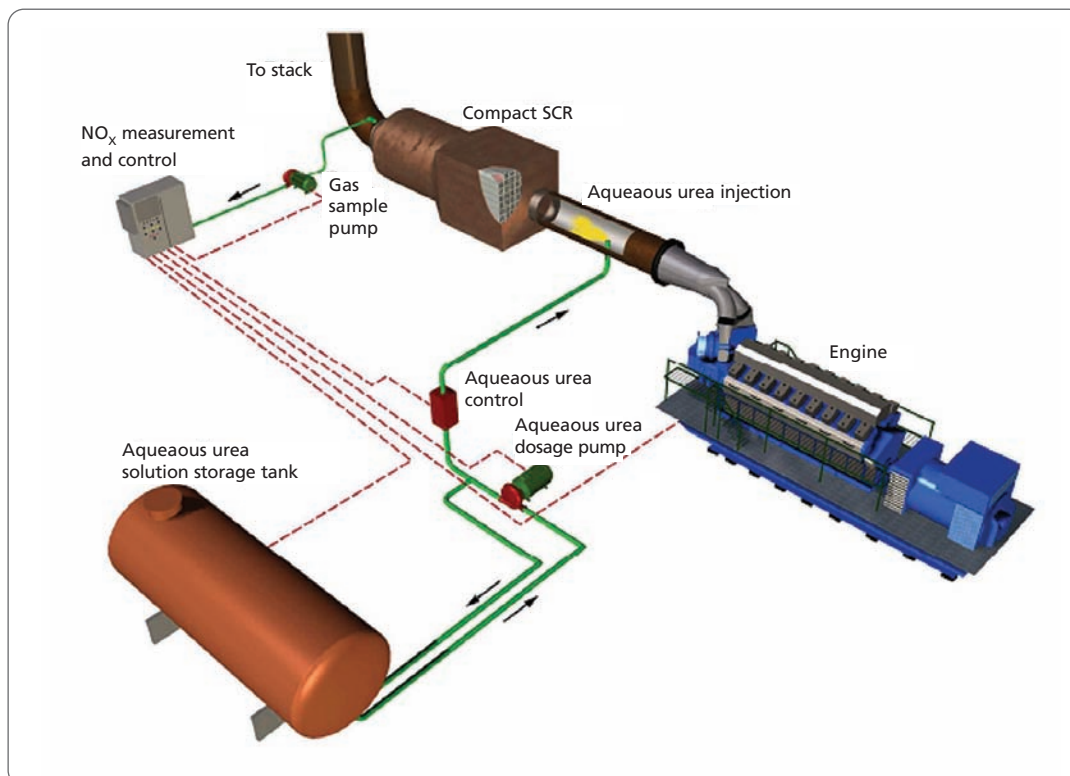

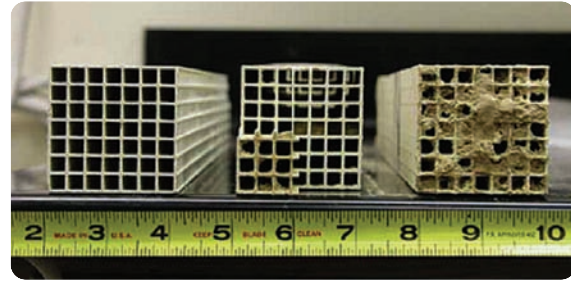

Figure 19: Catalyst element fouling

fuel consumption and lower CO₂ emissions. For this the SCR control system would require control set points for operation inside and outside of ECA-NO_x. It may be possible to apply this CO₂ saving when calculating a ship's EEDI.

SCR systems fitted to four-stroke medium speed engines

The exhaust temperature dictates the position of the reactor containing the catalyst. To date, virtually all marine SCR systems have been installed on four-stroke engines, as there is a sufficiently high exhaust temperature to allow efficient catalyst operation after the turbocharger. In this arrangement the reactor is fitted before any waste heat recovery system. When the SCR is not required, reactors may be run dry without the need for a bypass.

Effective catalytic reduction typically requires an exhaust temperature of over 300°C, but below 500°C to prevent thermal damage to the catalyst. It is possible to run at lower temperatures but the sulphur content of the fuel needs to be reduced to prevent deposits, which can plug the catalyst. The warming up period after engine start is typically 30 – 90 minutes (unless pre-warming equipment is fitted). This assumes that the engine loading is high enough to heat the SCR to its operating temperature. Extended operation at low loads will result in longer start up times and may result in the SCR not reaching its operating temperature. It is not yet clear how authorities will view ships that are non-compliant during the warming up period.

The reactor and mixing duct are installed as integral parts of the engine exhaust system; it is crucial that urea mixes completely with the exhaust gas before entering the SCR reactor.

The catalyst has a finite life and part of the maintenance regime for the SCR should be periodic analysis of catalyst activity. Empirical evidence from oil fired power plant SCR indicate that the two principal elements causing accelerated catalyst deactivation are potassium and sodium.

The mechanism for deposit formation involves an undesirable parallel reaction (to the NO_x conversion) at the catalyst whereby sulphur dioxide in the exhaust is oxidised to sulphur trioxide (SO₃), which can then react with ammonia to form ammonium sulphate and bisulphate. Deposits reduce the effective area and shorten the lifespan of the catalyst, with fuel-related hydrocarbon and particulate matter adding to the fouling. As conditions deteriorate, NO_x reduction is impaired and more un-reacted ammonia will slip past the catalyst. Figure 19 shows clean, partially fouled, and heavily fouled catalyst elements.

Manufacturers endeavour to minimise the oxidation of sulphur dioxide with their reduction catalyst materials and by specifying that only fuels with a sulphur content of less than 1.00% should be used. This not only prevents the formation of ammonium sulphates, but also sulphuric acid. Systems capable of operating with higher sulphur content are possible but higher exhaust temperatures are required. As an alternative to low-sulphur fuel, a SO_x scrubber fitted before the reactor may be used. When installed after a wet SO_x scrubber the exhaust gas would require reheating from around 50°C to at least 300°C. No reheat would be required for a dry scrubber.

An additional undesirable parallel reaction will take place if calcium is present, resulting in calcium sulphate deposits.

An oxidation catalyst may be included in the reactor after the reduction catalyst. Its purpose is to oxidise carbon monoxide (CO) and unburned hydrocarbons (HC) to water and carbon dioxide or act as a 'slip catalyst', oxidising un-reacted ammonia to nitrogen and water. An oxidation catalyst may also be fitted before the reactor to convert NO to NO₂, increasing the rate of NO_x reduction and allowing a reduced reactor size and lower operating temperature. Sulphur in the fuel is a concern, however, and must be limited for systems using oxidation catalysts, as oxidised SO₂ compounds form, deactivating and damaging the catalyst.

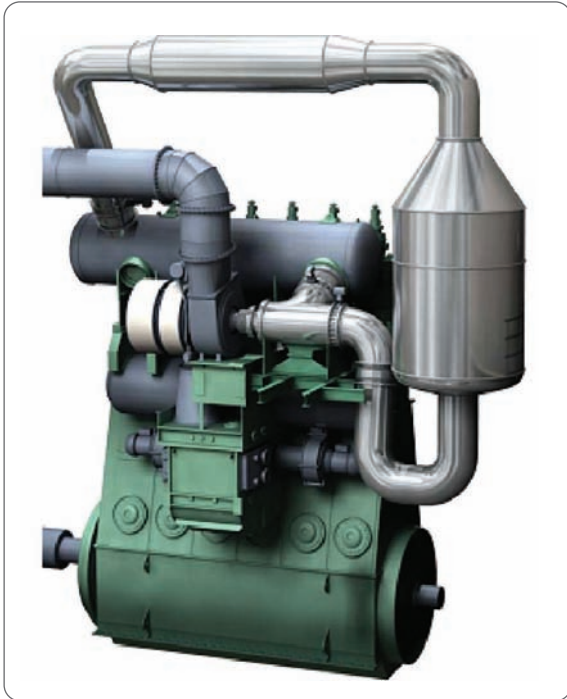

Figure 20: SCR arrangement – two-stroke low speed engine (image courtesy of MAN Diesel & Turbo)

SCR systems fitted to two-stroke low-speed engines

To date, a very small number of two-stroke low-speed engines have been equipped with SCR systems^[8,9]. For low-speed engines, the reactor is typically placed upstream of the turbocharger to provide the catalyst with a sufficiently high exhaust temperature. Figure 20 shows a two-stroke engine fitted with an SCR system. This type of installation is more challenging than for four-stroke engines because of space constraints and a need to bypass the reactor during various engine operating modes. The reactor in this configuration is relatively smaller than a downstream unit because the exhaust gas density is higher.

The catalyst has a significant heat capacity which means that for two-stroke engines the reactor must be bypassed at start-up and when rapidly accelerating to ensure sufficient energy reaches the turbocharger. Bypass may also be required when decelerating to prevent excess heat energy at the turbocharger. Despite the position of the reactor, the exhaust temperature may also be too low for efficient catalyst operation and for preventing ammonium sulphate deposits when the engine is operating at low loads on residual fuel.

As an alternative the reactor can be placed after the turbocharger on a two-stroke low speed engine if a burner is fitted to increase the exhaust temperature to the required level^[10].

Urea and catalyst

Typically, a 40% urea solution is injected as a fine spray into the mixing duct before the catalyst by means of compressed air. Effective dispersion of the urea in the

exhaust stream is critical to efficient SCR performance; this may be achieved by suitable injection nozzles, atomising air, high-pressure injection (typically 25 Bar), duct design, or a combination of all four. The urea converts to ammonia before entering the reactor.

Regular cleaning of filters in the urea handling system and the injection nozzles is an important part of the system maintenance requirements. Urea is classed as non-hazardous and can be stored in existing tanks if epoxy-coated. It is used because of the difficulty with the storage and direct handling of ammonia, which is both toxic and corrosive. Using poor quality urea does degrade the performance of the SCR. A standard for Maritime Grade Urea Solution based on work by the European Chemical Industry Council (CEPIC) is available from the International Association for Catalytic Control of Ship Emissions to Air (www.IACCSEA.com).

The rate of urea injection must be sufficient to reduce NO_x emissions to the required level but not so great that un-reacted ammonia exits the ship. 15 litres/MWh is typical for a 40% solution. Control is based on the load and speed of the engine with active feedback provided on some systems by NO_x and ammonia emissions monitoring. At engine start-up urea injection is initiated once the catalyst reaches operating temperature, which is key for effective NO_x reduction performance, deposit prevention and to avoid ammonia slip.

Catalysts have considerable heat capacity so the time taken to reach the injection trigger temperature is dependent on a number of factors including the minimum catalyst operating temperature recommended for the fuel type, the period of cool down since the engine was last operated, the size of the catalyst and the engine load pattern at start-up. Injection can begin up to 30 minutes after a fully cold start, whereas it may begin within 10–15 minutes if the catalyst is still warm from running in the previous 6–10 hours.

There will be similar considerations when entering an ECA-NO_x if the reactor has been bypassed, as the catalyst will need to be brought online and reach the required temperature before injection can commence. While these figures are indicative for both pre and post turbocharger catalysts, those fitted before turbochargers on two-stroke engines are relatively more compact and therefore should heat up more quickly.

In marine SCR systems the catalyst is typically made up of porous titanium dioxide (TiO₂) ceramic material in layers of replaceable honeycomb blocks. The high surface area construction acts as a carrier for the



A container ship passing under Bay Bridge, San Francisco, which will form part of the North American ECA

catalyst's active compounds such as vanadium pentoxide (V_2O_5) and tungsten trioxide (WO_3). The reactor and blocks can be orientated so the exhaust gas passes either vertically or horizontally, with the former favoured for higher particulate/dust applications. Regular cleaning by compressed air soot blowers or sonic horn is used to reduce fouling of the gas passages and catalyst surfaces. It should be noted that urea injection and soot blowing will likely require the installation of additional air compressor capacity sized for all SCR systems on board.

SCR catalyst material is susceptible to fouling, plugging and poisoning:

Fouling is a general deposition of material and is obvious when carrying out a visual inspection. The fouling masks the catalyst, preventing contact between the catalyst surface and the reactants. Fouling can be addressed by soot blowing and should not affect the life of the catalyst.

Plugging does not refer to plugging of the catalyst honeycomb (see figure 18) but rather the plugging of the catalyst pores. The catalyst is a very porous material, and to work effectively these pores must be open as they give the catalyst a very large contact area with the reactants. Plugging may not be seen during a visual inspection, as it can occur without there being a heavy deposition on the catalyst.

Poisoning refers to chemical attack of the active element of the catalyst. The activity of the catalyst will decay with age but it can be deactivated by attack from phosphorous or alkaline/heavy metals.

Catalyst lifespan depends on a number of factors that result in physical plugging of the catalyst pores, including combustion conditions, engine operating (load) regime, exhaust temperature and fuel sulphur level. In addition 'poisoning' can occur when fuel- and lubricating oil-related compounds in the exhaust are adsorbed onto the catalyst resulting in progressive chemical deactivation. These compounds are formed from alkali metals (sodium, potassium), alkaline earth metals (calcium, magnesium), phosphorus or zinc. Manufacturers may have strict limits on concentrations in the exhaust gas and as such it is important to follow recommendations regarding fuel and lubricating oils. Excessive lubricating oil consumption should be avoided, and certain biofuels, for example, could have a high level of alkali metals/alkaline earth metals.

Typical lifespan figures for catalyst blocks are between two and five years with replacement undertaken by the SCR vendors or authorised contractors. In California spent catalyst elements require specialist disposal because of the vanadium content. Generally, however, the material is not considered to be hazardous; metals are recycled and waste is removed to landfill.

The ongoing monitoring of catalyst condition is important, not only to ensure NO_x reduction is maintained but also to make sure that the injected urea is fully utilised to avoid ammonia slip. Emissions monitoring can also be utilised; increased urea feed to obtain the required NO_x reduction indicates a loss of catalyst efficiency, as does an increase in un-reacted ammonia at the catalyst outlet.

SO_x

Open

Closed

Hybrid

Dry

NO_x

SCR

EGR

7.2 Exhaust gas recirculation (EGR)

Exhaust gas recirculation is a mature technology within the automotive market, but new to ships. A proportion of the exhaust from before the turbocharger is reintroduced to the cylinders with the charge air. This lowers the oxygen content of the mixture and increases its heat capacity. This results in a reduction of peak combustion temperatures and hence the formation of thermal NO(x) is suppressed. As such, EGR is a method of primary NO_x control rather than a true exhaust gas treatment system.

Test engine work by MAN Diesel & Turbo has shown that, with 40% recirculation, EGR has the potential to reduce NO_x down to Tier III levels on a two-stroke low-speed marine engine and that increased fuel consumption, carbon monoxide emissions and PM emissions resulting from reduced combustion efficiency are manageable with engine adjustments. It is also reported that specific fuel consumption is much improved when using EGR to reduce NO_x down to Tier II limits, when compared with using engine adjustments to achieve the same level of emissions, particularly at part load. No high-speed or medium-speed engine manufacturer currently offers EGR NO_x abatement technology.

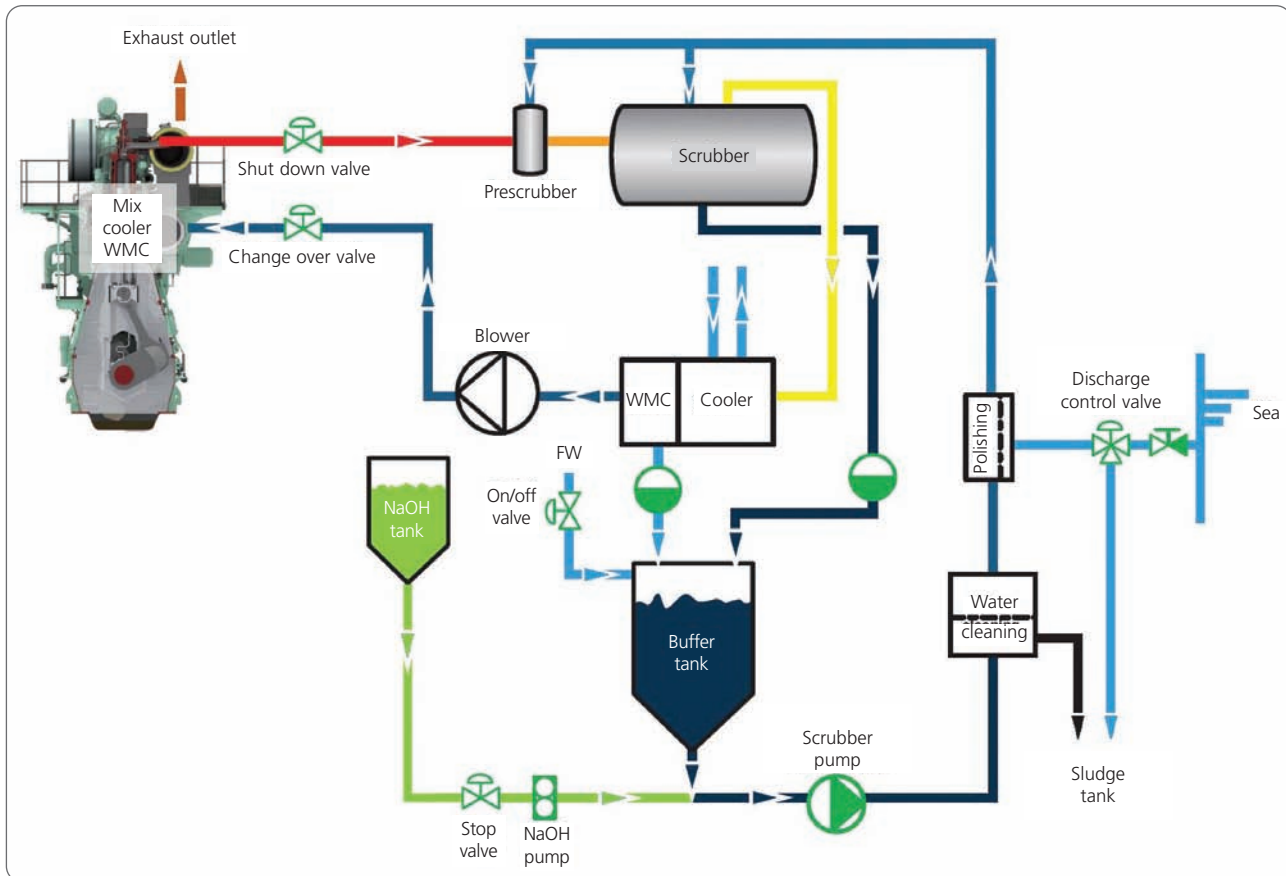

Figure 21: An EGR system arrangement – two-stroke low-speed engine (image courtesy of MAN Diesel & Turbo)

The main components of an exhaust gas recirculation system are shown in figure 21, and comprise:

- a high pressure exhaust gas scrubber fitted before the engine turbocharger
- a cooler to further reduce the temperature of the recirculated gas
- a water mist catcher (WMC) to remove entrained water droplets
- a high-pressure blower to increase recirculated gas pressure before reintroduction to the engine scavenge air
- automated valves for isolation of the system.

The scrubber in the EGR system is used to remove sulphur oxides and particulate matter from the recirculated exhaust, to prevent corrosion and reduce fouling of the EGR system and engine components. An EGR scrubber is more compact than a similar capacity scrubber after the turbocharger as the exhaust gas density is higher. The main washwater components are typical of a closed loop system using fresh water with sodium hydroxide treatment and comprise:

- a buffer tank with fresh water make-up
- a sodium hydroxide dosing device
- a circulating pump
- a water treatment plant with sludge collection.

A first generation MAN EGR has undergone a trial onboard *M.V. Alexander Maersk*. Initial issues with materials ^[11] required material upgrades and improved sodium hydroxide dosage because of iron and sodium sulphate deposits in the main engine air coolers, and corrosion of EGR system components including the cooler casing and blower. It has been reported that with an exhaust recirculation rate of 20% the target NO_x reduction of 50% was exceeded using 3.0% sulphur residual fuel without affecting the cylinder condition.

MAN is now constructing a second generation EGR system (see figure 22) based on the experience from the first trial. This will be installed on a larger



Figure 22: Graphic of the second-generation EGR system. The orange sections are the EGR system components, integrated into the engine (image courtesy of MAN Diesel & Turbo)

engine with the scrubber, cooler, water mist catcher and blower integrated into a single unit designed to be fitted in the same way as a charge air cooler. 40% exhaust recirculation is planned to achieve Tier III compliance.

Unlike selective catalytic reduction, fuel sulphur content and low load operation are not constraining factors for EGR systems. It should be noted, however, that although the EGR scrubber has been found to remove up to 80% of sulphur oxides in the recirculated gas, a further scrubber could be needed in the exhaust system after the turbocharger to be compliant in an ECA-SO_x when using high-sulphur fuel.

EGR systems can result in increased CO and particulate emissions, which may be controlled using additional techniques such as water in fuel to achieve an optimum balance between NO_x, CO and PM. Due to the nature of EGR systems' primary engine controls, system malfunction or deviations from normal operation can significantly reduce engine efficiency and increase CO and PM. There is also a risk of greatly accelerated engine wear and increased maintenance requirements if the scrubber does not clean and cool the exhaust gas to the required levels.





Appendix A1

Impacts of marine exhaust emissions on human health and the environment

A1.1 Carbon dioxide (CO₂) and water vapour

CO₂ and water vapour will be formed in all combustion processes in which complete or near complete combustion of a hydrocarbon fuel takes place. As such, the production of CO₂ and water vapour is a function of the quantity of fuel burnt. Climate change resulting from increased concentrations of CO₂ in the atmosphere is a well documented global concern. The input of water vapour (also a principal greenhouse gas) to the atmosphere is currently of little concern since the global average concentration is not changing and it has a relatively short lifespan.

A1.2 Sulphur oxides (SO_x)

Sulphur oxides derive directly from the sulphur content of the fuels used. The sulphur in the combustion chamber is oxidised, principally forming sulphur dioxide (SO₂) with a minor proportion of sulphur trioxide (SO₃).

Relatively close to the source and in the absence of rain, fog and snow, the 'dry precipitation' of gaseous SO₂ and acidic sulphate containing particulate matter is detrimental to human health and the environment, causing respiratory problems and damaging vegetation.

At sometimes considerable distances from the source the 'wet precipitation' of acid rain, fog or snow can have a directly negative impact on plant life and indirect effects on wider ecosystems. Damage to minerals used in the construction of buildings and other architecture can also occur.

A1.3 Nitrogen oxides (NO_x)

The formation of nitrogen oxides occurs as a result of oxidation of molecular nitrogen in the combustion air or, to a lesser extent, in the fuel. Adverse effects due to NO_x are diverse. Nitrogen dioxide (NO₂) causes respiratory problems and damage to vegetation, as well as contributing significantly to acid deposition. In addition, NO_x and non-methane hydrocarbons (nMHCs) are involved in a series of photochemical reactions leading to increased tropospheric ozone, which in turn may adversely affect human health, crop yield and natural vegetation.

A1.4 Hydrocarbons

The gaseous hydrocarbon fraction of exhaust gas will predominantly consist of unburned or partially combusted fuel and lubricating oils. Individual components may be present in either vapour or particulate phases. The diverse nature of hydrocarbon fraction components makes it difficult to both quantify the emissions and identify specific health and environmental problems. Polycyclic aromatic hydrocarbons (PAHs) are of particular note in this respect and are present in particulate emissions from all types of combustion sources.

As regards wider environmental effects, the non-methane hydrocarbons (nMHCs) are of concern on account of their involvement in photochemical reactions leading to the formation of tropospheric ozone (see nitrogen oxides above). Additionally, any significant methane emissions will be of concern because of both stratospheric ozone depletion and (as methane is a principal greenhouse gas) global climate change.

A1.5 Particulate matter (PM)

The particulates fraction of exhaust emissions represents a complex mixture of sulphate with associated water, non- or partially combusted hydrocarbon components, black carbon and heavy metals as represented by the ash fraction. Some flakes or deposits from the exhaust system may also be present. With the exception of the latter the majority of diesel particulates are likely to be less than 1µm in diameter and readily transportable by air currents. Potentially detrimental effects may thus be encountered outside the immediate vicinity of the exhaust gas stack.

Although study of marine diesel particulate exhaust composition is limited, extrapolation of results from other diesel applications would suggest that general respiratory problems as well as more serious toxic, mutagenic and carcinogenic effects might be encountered.

Black carbon is detrimental to human health (fine particles can penetrate deep into the lungs causing increased respiratory and heart problems) and is now recognised as being of concern in terms of global warming. When deposited on to snow and ice particularly in Arctic regions, light surfaces are darkened, albedo (reflectivity) is reduced and there is an increase in heat energy absorbed. Similarly, airborne black carbon particles absorb heat from sunlight, so warming the atmosphere.

In July 2011, the IMO agreed a work plan regarding black carbon, including actions to:

- develop a definition for black carbon emissions from international shipping
- consider measurement methods for black carbon and identify the most appropriate method for measuring black carbon emissions from international shipping
- investigate appropriate control measures to reduce the impact of black carbon emissions from international shipping; and submit a final report to the IMO in 2014, when MEPC should agree on the appropriate action(s).

MEPC is currently considering future controls on PM emissions, particularly for the most damaging fine and ultra fine particles of less than 2.5 microns ($PM_{2.5}$) and 100 nm ($PM_{0.1}$) respectively.

SO_x

Open

Closed

Hybrid

Dry

NO_x

SCR

EGR

Appendix B1

MEPC 184(59) – Exhaust Gas Cleaning System Guidelines

MEPC 184(59) – 2009 Guidelines for Exhaust Gas Cleaning Systems specifies the requirements for the test, certification and in-service verification of SO_x scrubbing systems.

MARPOL Annex VI requires that SO_x emissions limits be met by controlling the sulphur content of the fuel being combusted. SO_x scrubbers are approved as equivalent to the use of controlled fuels by the ship's flag administration or by a classification society acting as a recognised organisation on the flag administration's behalf. In principle, this approval of equivalency, supported by approved onboard documentation and records, should be accepted by port states as demonstrating compliance with MARPOL Annex VI. However, if the ship changes flag there is no guarantee that the receiving administration will accept the original approval and they may decide to request additional evidence on the performance of the system before issuing their approval.

The Guidelines apply to any SO_x scrubber fitted to fuel oil combustion machinery (excluding incinerators) as an alternative method of compliance with Annex VI, Regulation 14. There are two schemes available: Scheme A under which the SO_x scrubber is subject to initial certification of SO_x reduction performance followed by continuous monitoring of operating parameters and a daily spot check of emissions performance; or Scheme B in which there is no requirement for initial certification, but continuous emissions monitoring using an approved system and a daily spot check of operating parameters are required.

Currently the EC only accepts continuous emissions monitoring and the US Coastguard also appears to be predisposed to continuous emissions monitoring. Therefore, for those ships that either currently trade into EU or US waters, or may do so in the future, Scheme B approval would appear to be the sensible option.

The majority of sulphur oxide in an exhaust system is SO₂, which is almost entirely derived from the fuel's sulphur content. Unlike NO_x its formation is not related to engine design, operation or combustion conditions. The majority of CO₂ in the exhaust of a diesel engine is also derived from the fuel. The ratio of SO₂ to CO₂ therefore gives a measure of SO_x emissions in proportion to the sulphur content of the fuel consumed. This is very helpful as it allows for a significant reduction in the complexity of the monitoring system, as there is no need to integrate other engine operating parameters, such as speed and fuel consumption. It also readily allows the monitoring of other types of combustion units such as boilers, which do not directly produce a kW load.

The Guidelines therefore enable compliance with Regulation 14 to be demonstrated on the basis of the SO₂/CO₂ ratio values listed in table 4 below. (This is only applicable to the combustion of petroleum-based distillate and residual fuel oils.)

Fuel oil sulphur content (% m/m)	Ratio emission, SO ₂ (ppm)/CO ₂ (% v/v)
4.50	195.0
3.50	151.7
1.50	65.0
1.00	43.3
0.50	21.7
0.10	4.3

Table 4: The fuel oil sulphur limits recorded in MARPOL Annex VI Regulations 14.1 and 14.4 and corresponding emissions values

Each ship fitted with a scrubbing system will require a SO_x Emissions Compliance Plan (SECP). The plan, prepared by the ship operator, must demonstrate how the ship in its entirety will comply with Regulation 14 and must be approved by the administration. It is required to cover all fuel oil combustion units on the ship, whether fitted with scrubbers or not.

Document	Scheme A	Scheme B
SO _x Emissions Compliance Plan (SECP)	X	X
SO _x Emissions Compliance Certificate (SECC)	X	
EGC system – Technical Manual for Scheme A (ETM-A)	X	
EGC system – Technical Manual for Scheme B (ETM-B)		X
Onboard Monitoring Manual (OMM)	X	X
EGC Record Book or Electronic Logging System	X	X

Table 5: Scrubber document requirements

Table 5 summarises the documents required for Scheme A and Scheme B. These will be provided by the equipment manufacturer.

B1.1 Scheme A compliance

Scheme A for SO_x scrubbers is similar to EIAPP certification and the Parameter Check Method for NO_x. The basis of the procedure is that the performance of the scrubber is certified before going into service. Then, if all relevant components and operating parameters are within those in the approved EGC system – Technical Manual (ETM-A), the emissions reduction performance of the scrubber is within that required without the need for continuous exhaust emission measurements on the ship.

Under Scheme A, each scrubber must have a SO_x Emissions Compliance Certificate (SECC). This certifies it is capable of meeting an SO₂/CO₂ emissions value on a continuous basis at the specified exhaust gas flow rate and the maximum fuel oil sulphur content (typically 3.50% or higher), for the range of system operating parameters in the Technical Manual. The SO₂/CO₂ emissions value, the exhaust gas flow rate and the maximum fuel oil sulphur content are specified by the manufacturer.

The 'certified value' must be suitable for a ship's operating pattern, with the SO₂/CO₂ emissions being at least the equivalent of the applicable fuel sulphur limit under Regulation 14. (Generally the certified value for most scrubbers should be expected to be the equivalent of using 0.10% sulphur fuel.)

Certification testing can be carried out either on the test bed or after installation on board. Test data together with the Technical Manual is submitted by the manufacturer for approval. The scrubber must be tested over the defined range of exhaust gas flow rates with one or more fuel oils to demonstrate its operational performance and that the certified value can be achieved. On approval the SO_x Emissions Compliance Certificate is issued. (The Guidelines also give the methods by which identical, serially produced units and those of the same design, but of different capacity, from a production range may be certified without the need for repeat testing.)

A scrubber unit must be fitted to an engine or boiler for which it is rated. A survey is required after installation on board and the scrubber system is also subject to periodic survey. The Technical Manual must contain a verification procedure for the surveys and details of the combustion unit to which it is fitted. To ensure compliance in service there is a requirement for certain system operating parameters to be continuously recorded and daily spot checks of emissions are also recommended. It should be noted that if the scrubber system manufacturer cannot guarantee that the certified value or better will be met between surveys, or if the surveys require specialist equipment or knowledge, then it may be preferable to demonstrate compliance through continuous emissions monitoring (i.e., Scheme B rather than Scheme A).

Parameters that must be continuously recorded include scrubbing water pressure and flow rate at the scrubber unit inlet, exhaust gas pressure before and pressure drop across the scrubber unit, fuel oil combustion equipment load, and exhaust gas temperature before and after the scrubber. A record of chemical consumption must also be maintained. Limits and applicable ranges of these operating values must be contained within the Technical Manual. The parameters are intended to ensure water flow and chemical addition are at an optimum for scrubbing, that the back pressure imparted by the scrubber on the exhaust does not adversely impact engine operation, that the scrubber is not for some reason becoming blocked and that exhaust is not bypassing the scrubbing process. The Technical Manual must contain details of action to be taken in the event of the applicable SO₂/CO₂ ratio being exceeded.

An approved Onboard Monitoring Manual (OMM) is required to give details of the monitoring sensors and their position, and the care and calibration needed to demonstrate compliance. Continuously recorded data, including standard time and ship's position, must be securely stored for at least 18 months and be available for inspection as necessary to confirm compliance. Component adjustments, maintenance and service records, together with chemical consumption, if applicable, must be recorded in the system's EGC Record Book, which also must be approved. Alternatively, if approved, maintenance and service records can be recorded in the ship's planned maintenance system.

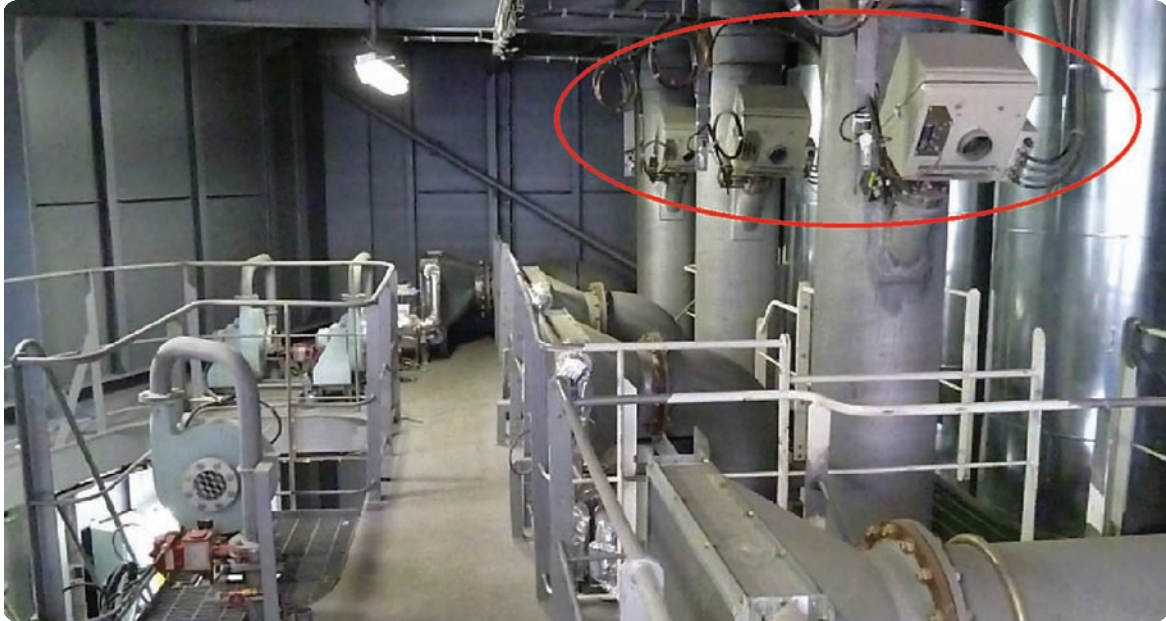

Figure 23: Continuous emissions monitoring systems (Image courtesy of Hamworthy-Krystallon)

B1.2 Scheme B compliance

Under Scheme B, a continuous emissions monitoring system (see figure 23) is required to show that the SO_2/CO_2 ratio of the scrubbed exhaust is less than or equal to the required SO_2/CO_2 ratio at any load point, including during transient operation, and thus compliant with Regulation 14.

The scrubber system is in effect treated as a 'black box' and unlike Scheme A there is no need for SO_x reduction performance to be certified before the scrubber is used in service. The continuous emissions monitoring system must, however, be approved and is subject to an initial survey at installation and periodic surveys thereafter.

As with Scheme A, Scheme B requires an approved Onboard Monitoring Manual (OMM) containing details of the monitoring sensors and their position, and the care and calibration needed to demonstrate compliance. Continuously recorded data, including standard time and ship's position, must be securely stored for at least 18 months and be available for inspection as necessary to confirm compliance.

An EGC System – Technical Manual (ETM-B) is also to be approved. Like Scheme A this must contain details of the combustion unit to which the scrubber is fitted, applicable operating values and limits, and action to be taken in the event of the relevant SO_2/CO_2 ratio being exceeded. Daily spot checks of various parameters required to verify proper operation of the scrubber must be logged in the system's EGC Record Book or the engine room logger system.

B1.3 Washwater and treatment residue

Regardless of the Scheme used, the condition of any washwater discharged to sea must be continuously monitored and data for the following parameters must be securely logged against time and ship's position.

- pH (a measure of acidity),
- PAH (a measure of the harmful components of oil); and
- turbidity (a measure of particulate matter).

A test for nitrate content is also required at each renewal survey.

Systems that require the addition of chemicals for the purpose of scrubbing or conditioning of washwater before discharge are required to undergo a specific assessment and, if necessary, additional washwater criteria should be established.

Residue from washwater treatment may not be incinerated and must be landed ashore. In some cases this sludge is landed in dedicated portable storage tanks (IBC). In others, the water is extracted from the sludge and it is carried ashore in bags for disposal, and in other cases the washwater sludge is piped into the sludge tank and disposed ashore with the sludge from the fuel oil purifiers.

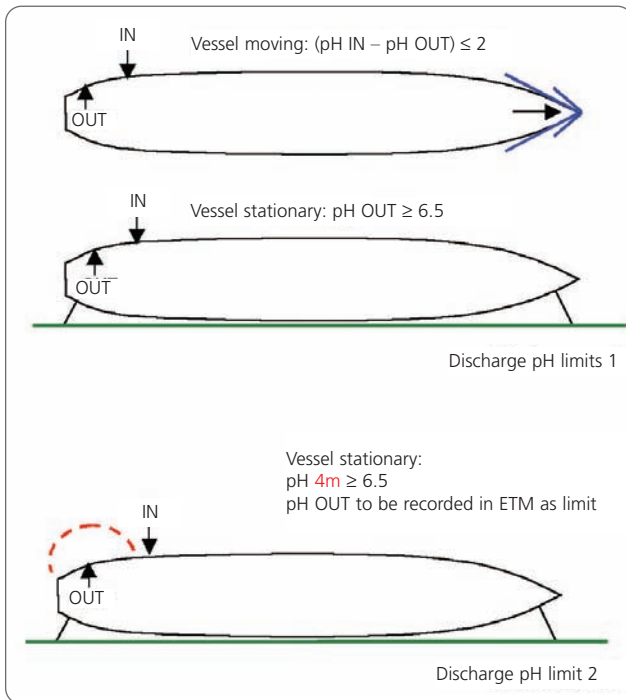

Figure 24: Washwater discharge pH limits (image courtesy of EGCSA)

B1.4 Washwater discharges – pH

Low pH water can have a detrimental impact on ecosystems and organisms such as shellfish, and can cause corrosion issues on the ship. The washwater immediately after scrubbing can have a pH of 4 or less. However, the Guidelines require the pH to comply with one of the following standards (also see Figure 25):

1. "The discharge washwater should have a pH of no less than 6.5 measured at the ship's overboard discharge with the exception that during manoeuvring and transit, the maximum difference between inlet and outlet of 2 pH units is allowed measured at the ship's inlet and overboard discharge"; or
2. "During commissioning of the [scrubber] unit(s) after installation, the discharged washwater plume should be measured externally from the ship (at rest in harbour) and the discharge pH at the ship's overboard pH monitoring point will be recorded when the plume at 4 metres from the discharge point equals or is above pH 6.5. The discharged pH to achieve a minimum pH units of 6.5 will become the overboard pH discharge limit recorded in the ETM-A or ETM-B."

While it is generally recognised that no environmental harm will arise from short-term exposure of organisms to seawater down to pH 6.5^[12], the rationale for the two limits in the first option is that discharged washwater will readily mix in a ship's wake, very quickly correcting the lower pH. However, this is not possible with a stationary ship so a tighter limit is applied.

In order to comply with the pH 6.5 limit, particularly at the ship's side in port, seawater can be used to dilute the washwater. A specific pump can be used for this purpose. However, it may also be possible to reduce energy consumption by using seawater that has already been used for cooling purposes in other engine room systems.

B1.5 Washwater discharges – particulate matter and oil

As particulate matter and potentially harmful components of oil could be discharged to sea within the washwater, the IMO Exhaust Gas Cleaning Systems Guidelines require turbidity and the concentration of polycyclic aromatic hydrocarbons (PAH) to be continuously monitored. Instruments have to be fitted after the washwater treatment plant but before any addition of fresh seawater or other treatment for pH correction.

PAHs are produced from a wide range of activities that involve the combustion of fossil fuels and hence may be present in the seawater taken up by the ship. The IMO Guidelines take this into account and allow PAH and turbidity readings at system inlet to be deducted from discharge figures.

The IMO Guidelines have limits for just one PAH – phenanthrene – which is prevalent in diesel exhaust and an indicator for the possible presence of others. In order to control the quantity of PAH at discharge, limits on concentration above the system inlet level are given at various washwater flow rates, with a higher concentration being allowable at low discharge rates and vice versa. The Guidelines also prescribe the measurement technologies that should be employed to ensure that instruments with an appropriate sensitivity are used. Instruments either detect:

- the amount of ultra violet light absorbed by PAHs at high concentrations and low washwater flow rates, or
- the intensity of the light emitted by PAHs (fluorescence) at low concentrations and high washwater rates.

Turbidity is a measure of the loss of transparency of a liquid because of the particulates suspended within it. Although this can be used to monitor the removal of exhaust-related material by the washwater treatment plant, sediment entrained in the seawater at scrubber system inlet can impact the validity of readings particularly whilst the ship is manoeuvring. The Guidelines therefore have turbidity limits based on a rolling 15-minute average of the difference between turbidity at inlet and discharge.

B1.6 Washwater discharges – nitrates

NO_x is comprised mainly of nitric oxide (NO) formed during combustion, with a small amount of nitrogen dioxide (NO₂) formed by oxidation of NO in the exhaust. The solubility of NO is poor, whereas NO₂ reacts with water to form nitric acid (HNO₃) together with a reduction back to NO. This means conventional wet scrubbing will remove a small amount of NO_x from exhaust gas (generally less than 5%). The little that is removed is converted to nitrate, and also nitrite in SO_x scrubbers that use sodium hydroxide (NaOH).

Nitrates are important nutrients that promote the growth of organisms, but excess levels of nitrates, phosphates and sediment can lead to eutrophication in aquatic ecosystems, resulting in excessive growth of some organisms such as algae. Algal blooms can be toxic, reduce water clarity and starve water of the oxygen needed for fish, shellfish and plants to survive below the surface.

In near-shore waters, phosphates are available from industrial, agricultural and domestic activities; typical sources include detergents, sewage and run-off from fertilised land. The introduction of nitrates in large quantities is therefore undesirable.

Because the quantity of NO_x removed by conventional wet scrubbers is small, the Guidelines do not require continuous monitoring of overboard nitrate emissions. However, to mitigate the risk of eutrophication there is a nitrate limit based on scrubbing 12% of the NO_x from an exhaust stream (significantly more than is usually achieved). It is required that laboratory analysis of a washwater sample is undertaken in the three months leading up to each five yearly renewal survey and that the results are retained in the Exhaust Gas Cleaning Record Book, so they are available for flag and port state inspections. The Scrubber Technical Manual (ETM-A or ETM-B) must contain details of the sampling and analysis programme and typical nitrate levels if above 80% of the limit figure.

B1.7 Washwater discharges – other effects on seawater

There are a number of other effects not specifically mentioned in the Guidelines. When dissolved in water sulphur oxides undergo a process of ionisation and oxidation to form sulphate. The reaction is buffered by the alkalinity of the scrubbing water, which is naturally

imparted by seawater in open loop systems and by the addition of sodium hydroxide in closed loop systems. There is a common misconception that the transfer of sulphur to the ocean in the form of sulphate is in itself detrimental to ecosystems. In fact, sulphate is a major and stable constituent of seawater, a significant source being natural volcanic activity and seafloor degassing. It is relatively easy to estimate the total sulphur content of global oceans for comparison with the total sulphur content of all known oil reserves, to show how minor the contribution of the latter is.

While scrubbing prevents damaging sulphur oxides and particulate matter entering the atmosphere, the process involves two other reactions that should be considered.

Firstly, the formation of sulphate requires oxygen and so increases chemical oxygen demand (COD). This is indirectly addressed by the IMO Exhaust Gas Cleaning Systems Guidelines as it has been independently shown that oxygen levels will rapidly recover to within 1% of the receiving waters if pH limits are met. An exception to this occurs in warmer open seas, where up to 50% extra dilution is required for oxygen levels to normalise^[12]. This dilution is readily available particularly as the ship will almost certainly be underway, causing the discharge to be mixed with fresh seawater in the ship's wake.

The other consideration is the impact that discharges of low pH washwater may have on receiving waters. The reaction below shows the ocean carbonate system and illustrates the interaction of carbon dioxide with seawater. Atmospheric CO₂ dissolves in the sea to form carbonic acid. Carbonic acid then dissociates by losing hydrogen ions to form bicarbonate. The increase in hydrogen ion concentration lowers the pH of the water, thereby increasing acidity. Available carbonate from shells and skeletons of marine organisms that are either dissolved in the seawater or deposited in sediments then combine with the hydrogen ions to resist further changes in pH. Using bicarbonate and carbonate to buffer washwater moves the reaction to the left and so causes increased acidity. Independent study has however shown that this is an order of magnitude smaller than that caused by CO₂ emissions from fossil fuel consumption^[12].

Ocean carbonate system:

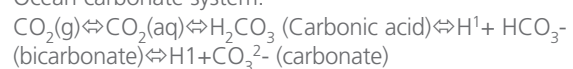

Appendix B2

NO_x Technical Code

SO_x

Open

Closed

Hybrid

Dry

NO_x

SCR

EGR

The NO_x emissions of Tier I and Tier II (see section 3.1) engines do not require NO_x-reducing devices, as NO_x is controlled using primary, in-engine controls to constrain the combustion temperature and hence the formation of NO_x. Certification of Tier I and Tier II engines is issued following successful test bed measurements of the relevant load points for the test cycle that is applicable for the function and configuration of the engine. There are three methods for confirming that the engine's in-service NO_x emissions remain within the applicable limits.

By far the most common is the parameter check method. A pre-certified engine is surveyed when installed and then periodically thereafter. The principle of this approach is that if all relevant components and operating parameters are within those included and approved in the engine's Technical File, then the NO_x emissions will not exceed the approved values. The simplified measurement method is similar to pre-certification testing, but with some simplification. However, it does require the engine to be run over the whole of the applicable duty cycle at each survey or port state inspection.

Under the direct measurement and monitoring method an approved emissions monitoring system is used to measure NO_x while the engine is in service. Using these measurements, as well as other engine operating parameters and typically CO₂ concentration to determine exhaust flow rate, the specific g/kWh NO_x emissions are calculated at the relevant engine test cycle load and speed points. Data have to be compiled within 30 days of survey in order to be considered current. Under new guidelines that were adopted at MEPC 63 the SCR system is recognised as being a component of the engine; therefore pre-certification of the combined arrangement (engine + SCR) would typically be on a test bed before installation on board. This is referred to as Scheme A.

If it is not possible to test an engine and SCR together, either on a test bed or on board because of the size or construction of the arrangement, an alternative Scheme (Scheme B) allows for the engine and SCR to be tested separately subject to the agreement of the Administration. The NO_x emissions from the engine are tested as usual in accordance with the appropriate test cycle. The NO_x reduction performance of the SCR can be based on modelling tools using data from either a full size or scaled down version. The overall NO_x emission value (g/kWh) is calculated by combining the engine emissions and SCR emission reduction rate at each load/speed point in the test cycle. Data is then entered into the engine's Technical File and the parent engine EIAPP^h certificate. A final and simpler confirmation test is carried out on board whereby the emissions concentration (parts per million (ppm)) is measured at the inlet and outlet of the SCR chamber and compared with the Technical File entries.

With this approach there are concerns as to the reliability and robustness of the modelling of the SCR's performance and the associated scale model testing which would be used to calculate the estimated NO_x emission value entered on the Supplement to the EIAPP Certificate. These concerns arise particularly because the confirmation test is only to be undertaken on the parent engine after installation on board and hence may not fully reflect all the influencing factors which in practice could affect the performance of individual SCR units. Given these concerns, shipowners, who will be responsible for the ongoing in-service demonstration of compliance, may, irrespective of the engine's NO_x certification status, be looking to see that a confirmation test is satisfactorily completed on each and every SCR-fitted engine, even identical engines, as part of the ship trials before acceptance.

Amendments to the NO_x Technical Code 2008 enabling the Scheme B pre-certification procedure were adopted at MEPC 63. However, detailed procedures demonstrating ongoing compliance based on emission monitoring are expected to be further developed.

^h Engine International Air Pollution Prevention

Appendix B3

Regional, national and local air quality regulations

Table 6 shows the major regional, national and local regulations that currently apply to international shipping, none of which control NO_x emissions. Further information is provided in the sections below.

B3.1 European Union

European Council Directive 1999/32 as amended by EC 2005/33 relates to the sulphur content of marine fuels. In addition to incorporating the Baltic ECA-SO_x and North Sea ECA-SO_x (which includes the English Channel) into national law, European Union member states are directed to ensure all ships, regardless of flag, use fuel containing no more than 0.10% sulphur 'at berth', which is defined as including ships at anchor within port. Any fuel changeover operation must occur as soon as possible after arrival at berth, and as late as possible before departure, and be logged. The Directive also requires that during 'regular' service between member state ports and in EU waters, passenger ships must use fuel containing no more than 1.50% sulphur, unless in ECA-SO_x in which case the lower ECA-SO_x limit applies. Further information can be found in the LR FAQs on the EC Directive requirements^[13].

EC 2005/33 allows technologies such as SO_x scrubbers to be used either during a trial approved by an EU member state or as an alternative to complying with fuel rules, if the equipment has been properly approved, taking into account the IMO MEPC 184(59) Exhaust Gas Cleaning System Guidelines.

If used, scrubbers must continuously achieve emission reductions that are at least as low as those achieved by the Directive's sulphur-in-fuel limits. Scrubbing systems therefore have to be fitted with continuous emissions monitoring equipment (i.e., use MEPC 184(59) Scheme B), and ships must "document thoroughly that any waste streams discharged into enclosed ports, harbours and estuaries have no impact on ecosystems".

EC 1999/32 and 2005/33 are no longer fully aligned with Annex VI following its revision in 2008. The Commission is therefore consulting with industry stakeholders and EU governments on amendments to the Directive, and an update is due to be finalised during 2012^[14]. Aspects in which the EC requirements may differ include: applying the 0.50% sulphur limit

	SO _x	SO _x scrubbers permitted?	NO _x	Comments
Europe EC Directive 1999/32 as amended by 2005/33	"Sulphur Content of Marine Fuels" Includes specific low-sulphur fuel rules for ships in port and passenger ships on regular service in the EU	✓ (with continuous emissions monitoring)	No regulation	The Directive is currently under review to improve alignment with MARPOL Annex VI. However, it is likely that the Directive may also include additional requirements (see section B3.1).
USA Title 40 of the US Code of Federal Regulations, CFR Part 1043	Control of SO _x and PM from ships subject to MARPOL Annex VI	✓	No regulation	The requirements are under review. There are indications that in future the US may not accept exhaust gas treatment systems unless they are fitted with continuous monitoring of exhaust emissions.
California (Title 13 California Code of Regulations, CCR section 2299.2)	Fuel sulphur and other operational requirements within California waters and 24 nautical miles off the California coast	✗	No regulation	Specific low-sulphur fuel rules for ships visiting California

Table 6: Key regional, national, and local regulations

outside of ECA-SO_x in 2020, irrespective of the outcome of the IMO review in 2018; and that there may be no allowance to use fuel with a sulphur content greater than 3.50% with certain types of scrubber.

B3.2 North America

Under United States federal marine air pollution regulation, the Environmental Protection Agency (EPA) defines three categories of engine, subdivided by cylinder displacement and engine power or speed. Each sub division has Tiers of reducing emission limits for NO_x, particulate matter, carbon monoxide and hydrocarbons and a model year from which the limits will apply to domestically operated engines^[15].

Title 40 of the US Code of Federal Regulations, CFR Part 1043^[16] incorporates MARPOL Annex VI into US Law. The regulation applies to all US flagged ocean-going ships operating worldwide including the United States and foreign flag ships while in US waters. As such, emissions of SO_x, PM and NO_x are controlled from the largest category 3 marine engines with a per cylinder displacement of over 30 litres and approved exhaust gas cleaning systems are allowed as an alternative. Smaller category 1 and 2 auxiliary engines on ships with category 3 propulsion engines are also permitted to comply with MARPOL Annex VI under 40 CFR Part 1042.650 and Part 80^[17, 18].

B3.3 California

In addition to US federal emission controls based on Annex VI, California has its own Regulation on Fuel

Sulphur and Other Operational Requirements for Ocean-Going Vessels within California Waters and 24 Nautical Miles of the California Baseline^[20]. The fuel rule was updated by the Air Resources Board (ARB) following the adoption of the North American ECA-SO_x and applies to all main and auxiliary engines and auxiliary boilers (but not emergency engines) unless a ship is on passage through regulated waters or if compliance would put the ship and people on board in danger due to extraordinary circumstances. If ships are to berth or anchor within California Waters or enter an inland waterway or estuary the requirements in Table 7 apply.

California only permits the use of exhaust control technologies, including SO_x scrubbers, in trials as part of a research programme officially approved by the Californian authorities. Before the end of the trial the ship must be brought back into full compliance with fuel rule requirements.

The regulation also includes provision for its own termination, which states the fuel requirements will cease to apply if the USA adopts and enforces controls that yield equivalent emissions reductions. California, however, specifies the use of distillate fuels, with an implementation timeline that differs in part to the federal legislation enacting Annex VI. It therefore appears that this will not happen before 1 January, 2015, when it will be necessary to comply with the 0.10% sulphur limit by using distillate fuel in the North American ECA.

Fuel requirement	Effective date	Fuel grade requirement and sulphur limit
Phase 1	1 July, 2009	Marine gas oil (DMA/DMZ) at or below 1.5% sulphur; or Marine diesel oil (DMB) at or below 0.5% sulphur
	1 August, 2012	Marine gas oil (DMA/DMZ) at or below 1.0% sulphur; or Marine diesel oil (DMB) at or below 0.5% sulphur
Phase 2	1 January, 2014	Marine gas oil (DMA/DMZ) or marine diesel oil (DMB) at or below 0.1% sulphur

Table 7: California fuel regulation requirements

Appendix C

Chemical reactions

C1.1 Wet open loop SO_x scrubber (including hybrid system operating in open loop mode)

SO_x scrubbing media is seawater. Sulphur dioxide (SO₂) is dissolved and ionised to bisulphite and sulphite, which is then readily oxidised to sulphate in seawater containing oxygen. Similarly sulphuric acid, formed from SO₃, and hydrogen sulphate dissociate completely to sulphate.

For SO₂:

- $\text{SO}_2 + \text{H}_2\text{O} \rightleftharpoons \text{H}_2\text{SO}_3$ (sulphurous acid) $\rightleftharpoons \text{H}^+ + \text{HSO}_3^-$ (bisulphite)
- HSO_3^- (bisulphite) $\rightleftharpoons \text{H}^+ + \text{SO}_3^{2-}$ (sulphite)
- SO_3^{2-} (sulphite) + $\frac{1}{2} \text{O}_2 \rightleftharpoons \text{SO}_4^{2-}$ (sulphate)

For SO₃:

- $\text{SO}_3 + \text{H}_2\text{O} \rightleftharpoons \text{H}_2\text{SO}_4$ (sulphuric acid)
- $\text{H}_2\text{SO}_4 + \text{H}_2\text{O} \rightleftharpoons \text{HSO}_4^-$ (hydrogen sulphate) + H_3O^+ ⁱ
- HSO_4^- (hydrogen sulphate) + $\text{H}_2\text{O} \rightleftharpoons \text{SO}_4^{2-}$ (sulphate) + H_3O^+

C1.2 Wet closed loop SO_x scrubber (including hybrid system operating in closed loop mode)

SO_x scrubbing media is fresh water dosed with sodium hydroxide (NaOH). Sulphur oxides are dissolved and react to form sodium bisulphite, sulphite and sulphate. The proportion of each is dependent on the pH and available oxygen.

For SO₂:

- $\text{Na}^+ + \text{OH}^- + \text{SO}_2 \rightleftharpoons \text{NaHSO}_3$ (aq sodium bisulphite)
- $2\text{Na}^+ + 2\text{OH}^- + \text{SO}_2 \rightleftharpoons \text{Na}_2\text{SO}_3$ (aq sodium sulphite) + H_2O
- $2\text{Na}^+ + 2\text{OH}^- + \text{SO}_2 + \frac{1}{2} \text{O}_2 \rightleftharpoons \text{Na}_2\text{SO}_4$ (aq sodium sulphate) + H_2O

For SO₃:

- $\text{SO}_3 + \text{H}_2\text{O} \rightleftharpoons \text{H}_2\text{SO}_4$ (sulphuric acid)
- $2\text{NaOH} + \text{H}_2\text{SO}_4 \rightleftharpoons \text{Na}_2\text{SO}_4$ (aq sodium sulphate) + $2\text{H}_2\text{O}$

C1.3 Dry SO_x scrubber

In a dry SO_x scrubber using calcium hydroxide (Ca(OH)₂) the reaction with sulphur dioxide forms calcium sulphite:

- $\text{SO}_2 + \text{Ca(OH)}_2 \rightleftharpoons \text{CaSO}_3$ (calcium sulphite) + H_2O

The sulphite is then oxidised and hydrated in the exhaust stream to form calcium sulphate dihydrate, or gypsum:

- $2\text{CaSO}_3 + \text{O}_2 \rightleftharpoons 2\text{CaSO}_4$ (calcium sulphate)
- $\text{CaSO}_4 + 2\text{H}_2\text{O} \rightleftharpoons \text{CaSO}_4 \cdot 2\text{H}_2\text{O}$ (calcium sulphate dihydrate - gypsum)

Similarly for SO₃:

- $\text{SO}_3 + \text{Ca(OH)}_2 + \text{H}_2\text{O} \rightleftharpoons \text{CaSO}_4 \cdot 2\text{H}_2\text{O}$ (calcium sulphate dihydrate - gypsum)

C2.1 Selective Catalytic Reduction

Urea decomposition before the catalyst:

- $(\text{NH}_2)_2\text{CO}$ (urea) $\rightleftharpoons \text{NH}_3$ (ammonia) + HNCO (isocyanic acid)
- $\text{HNCO} + \text{H}_2\text{O} \rightleftharpoons \text{NH}_3 + \text{CO}_2$

(Note the resulting quantity of CO₂ is minor when compared with that resulting from fuel combustion)

NO_x reduction at the catalyst:

1. $4\text{NO} + 4\text{NH}_3 + \text{O}_2 \rightleftharpoons 4\text{N}_2 + 6\text{H}_2\text{O}$
2. $2\text{NO} + 2\text{NO}_2 + 4\text{NH}_3 \rightleftharpoons 4\text{N}_2 + 6\text{H}_2\text{O}$
3. $6\text{NO}_2 + 8\text{NH}_3 \rightleftharpoons 7\text{N}_2 + 12\text{H}_2\text{O}$

Equation 1 shows the main SCR reaction as nitric oxide dominates in the exhaust. The reaction shown at equation 2 occurs at the fastest rate up to an NO₂:NO ratio of 1:1. However, at higher ratios the excess NO₂ reacts slowly as per equation 3.

ⁱ Hydronium is a water molecule with an extra hydrogen ion attached to it ($\text{H}_2\text{O} + \text{H}^+ \rightleftharpoons \text{H}_3\text{O}^+$). An acid is any compound that yields hydrogen ions (H⁺) or hydronium ions (H₃O⁺) when dissolved in water

Acronyms and abbreviations

DME	Dimethyl ether – a synthetic fuel formed from natural gas or biofuel	GRE	Glass reinforced epoxy – a corrosion-resistant material that can be used for the construction of SO _x scrubber washwater pipes, process tanks and holding tanks
ECA-NO _x	Emission control area for nitrogen oxides under MARPOL Annex VI	HAM	Humid air motor
ECA-SO _x	Emission control area for sulphur oxides under MARPOL Annex VI	IBC	Intermediate bulk container
ECA-SO _x /NO _x	Emission control area for sulphur oxides and nitrogen oxides under MARPOL Annex VI	IMO	International Maritime Organization
EEDI	Energy Efficiency Design Index	LNG	Liquefied natural gas
EEOI	Energy Efficiency Operational Indicator	MEPC	Marine Environment Protection Committee
EPA	Environmental Protection Agency	MSDS	Material Safety Data Sheet
EGR	Exhaust gas recirculation – engine technology to reduce NO _x formation by reintroducing cleaned exhaust gas into the charge/scavenging air	OMM	Onboard Monitoring Manual – the approved manual that details the monitoring sensors used to demonstrate compliance with MARPOL Annex VI SO _x limits
EGCS	Exhaust gas cleaning system – the term used by MEPC to refer to SO _x scrubbers	PAH	Polycyclic aromatic hydrocarbon
EGCSA	Exhaust Gas Cleaning Systems Association www.egcsa.com	PM	Particulate matter
EGTS	Exhaust gas treatment system – the term used in this guidance to refer to either SO _x scrubbers or NO _x scrubbers	PPE	Personal protective equipment
ETM-A	EGCS – Technical Manual for Scheme A – the manual containing all the relevant components and operating parameters for an EGCS to meet MARPOL Annex VI SO _x limits under the Scheme A approval process	SAM	Scavenging air moistening
ETM-B	EGCS – Technical Manual for Scheme B	SEAA	Shipping Emissions Abatement and Trading – a cross-industry group whose mission is to encourage and facilitate efficient reduction of harmful emissions to air from shipping
GESAMP	Joint Group of Experts on the Scientific Aspects of Marine Environmental Protection www.gesamp.org	SECC	SO _x Emissions Compliance Certificate – certifies that a scrubber will reduce SO _x emissions to the required level when fuel oil of a specified maximum sulphur content is consumed
		SECP	SO _x Emissions Compliance Plan – the Plan describing how the overall ship will meet MARPOL Annex VI SO _x limits
		SCR	Selective catalytic reduction
		VCG	Vertical centre of gravity
		VGP	Vessel General Permit

References

1. *Lloyd's Register Marine Exhaust Emissions Research Programme*. Final Report, Lloyd's Register.
2. MEPC 184(59) – 2009 *Guidelines for Exhaust Gas Cleaning Systems*
3. *NO_x Technical Code*. IMO Resolution MEPC.177(58)
4. *Marine Engineering Practice Series, Volume 3 Part 20 – Exhaust Emissions from Combustion Machinery*. Wright. Publisher: IMarEST, 2000. ISBN 1-902536-17-7
5. MEPC 59/INF.15: *Study Pertaining to Ship Emissions' Impact on Climate Change and Air Quality*. United States. International Maritime Organization, 2009
6. *Alaska Opacity and Excess Emissions Regulations*
7. MEPC 59/6/5: *Proposal to Designate an Emission Control Area for Nitrogen Oxides, Sulphur Oxides and Particulate Matter*. United States and Canada. International Maritime Organization, 2009
8. *IMO Tier III solutions for Wärtsilä 2 stroke engines – Selective Catalytic Reduction (SCR)*
9. *Tier III Compliance. Low Speed Engines*. MAN Diesel & Turbo
10. *World's First SCR NO_x Removal System Installed on Coal Bulker Built by Oshima Shipbuilding – Aiming to Meet the IMO's Tier III NO_x Emission Controls*. NYK Line et al. June 2011
11. *Developments in Engine Technology for Green Ship Designs*. Clausen MAN Diesel & Turbo. October 2010
12. *Seawater Scrubbing – Reduction of SO_x Emissions from Ship Exhausts*. Karle and Turner. The Alliance For Global Sustainability Gothenburg, 2007
13. *The Practical Applications of the 'At Berth' Requirements*, Lloyd's Register.
www.lr.org/sectors/marine/documents/175157-the-practical-applications-of-the-at-berth-requirements-faq.aspx
14. *EU policy on ship emissions*.
<http://ec.europa.eu/environment/air/transport/ships.htm>
http://ec.europa.eu/environment/air/transport/pdf/sulphur_standard_shipping.pdf
15. *EPA policy on ship emissions*:
www.epa.gov/otaq/oceanvessels.htm
www.epa.gov/otaq/marine.htm
16. Electronic Code of Federal Regulations e-CFR Title 40 *Protection of Environment Part 1043 Control of NO_x, SO_x and PM Emissions from Marine Engines and Vessels subject to the MARPOL Protocol* -
www.gpoaccess.gov/ecfr/index.html
17. Electronic Code of Federal Regulations e-CFR Title 40 *Protection of Environment Part 1042 Control of Emissions from New and In-Use Marine Compression-Ignition Engines and Vessels* -
www.gpoaccess.gov/ecfr/index.html
18. Electronic Code of Federal Regulations e-CFR Title 40 *Protection of Environment Part 80 Regulations of fuels and fuel additives* -
www.gpoaccess.gov/ecfr/index.html
19. Electronic Code of Federal Regulations e-CFR Title 40 *Protection of Environment Part 110 Discharge of oil*
www.gpoaccess.gov/ecfr/index.html
20. *California policy on ship emissions*:
www.arb.ca.gov/ports/marinevevss/ogv.htm
21. *Market-based Instruments for NO_x Abatement in the Baltic Sea*, Per Kågeson.

For further information please
contact us at
marine_environment@lr.org

For further information about our
exhaust emissions services visit
www.lr.org/eca

www.lr.org

June 2012

Lloyd's Register is a trading name of the Lloyd's Register Group of entities.
Services are provided by members of the Lloyd's Register Group. For details see www.lr.org/entities

