

#WORLDSTANDARDSDAY



Dr. François Coallier
Chair JTC 1/SC 41
Internet of Things
and Digital Twin
francois.coallier@etsmtl.ca

Internet of Things and Digital Twin applications in the health sector

Presentation summary

The Internet of Things (IoT) is an enabler of 'smarter' environments in multiple sectors. Together with Digital Twin (DTw) technologies, it is demonstrating an evolving potential to not only optimise existing services but also create new one.

The purpose of this presentation is to provide an introductory overview of the applications of these concepts and technologies in the health sector.

v1.0



Content

- A framework - BioDigital convergence
- The Internet of Things
 - ICT Technologies integrated in IoT Systems
- IoT Healths applications
- Digital Twin overview
- Digital Twin applications
- Conclusion
- Annexes: ISO/IEC JTC 1/SC 41

A Framework: BioDigital Convergence

<https://horizons.gc.ca/en/2022/05/31/biodigital-today-and-tomorrow/>

BioDigital Convergence

**convergence of engineering,
nanotechnology, biotechnology,
information technology and cognitive
science**

Note 1 to entry: convergence means the creative union of sciences, technologies, engineering and peoples, focused on mutual benefit; this is a process requiring increasing integration across traditionally separate disciplines, areas of relevance, and across multiple levels of abstraction and organization.

[SOURCE: Modified from: M. C. Roco, W. S. Bainbridge, B. Tonn, and G. Whitesides, Eds., *Convergence of Knowledge, Technology and Society: Beyond Convergence of Nano-Bio-Info-Cognitive Technologies*. Cham: Springer International Publishing, 2013. doi: 10.1007/978-3-319-02204-8.]

BioDigital Convergence -

a ~20 years old concept!

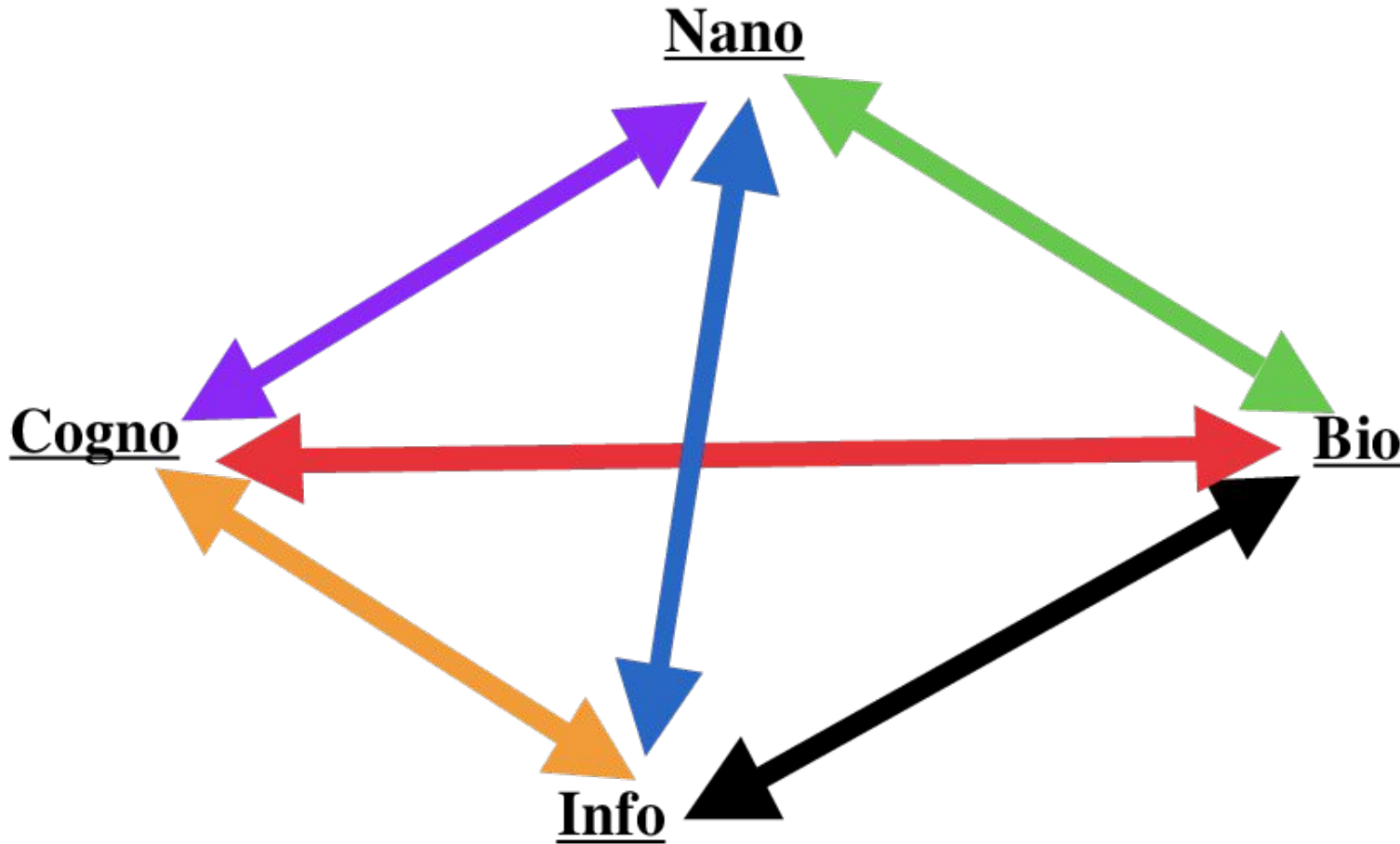

In the context of BioDigital convergence, *‘The phrase “convergent technologies” refers to the synergistic combination of four major “NBIC” (Nano-Bio-Info-Cogno) provinces of science and technology, each of which is currently progressing at a rapid rate: (a) nanoscience and nanotechnology; (b) biotechnology and biomedicine, including genetic engineering; (c) information technology, including advanced computing and communications; and, (d) cognitive science, including cognitive neuroscience.’ [1]*

[1] Roco, Mihail & Bainbridge, William (2003). Converging Technologies for Improving Human Performance.

https://www.researchgate.net/publication/252444145_Converging_Technologies_for_Improving_Human_Performance

JTC 1 World Standards Day 2023 - F. Coallier

Also in DOI : 10.1007/978-94-017-0359-8

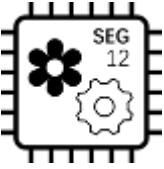

**Zoom in:
decomposing**

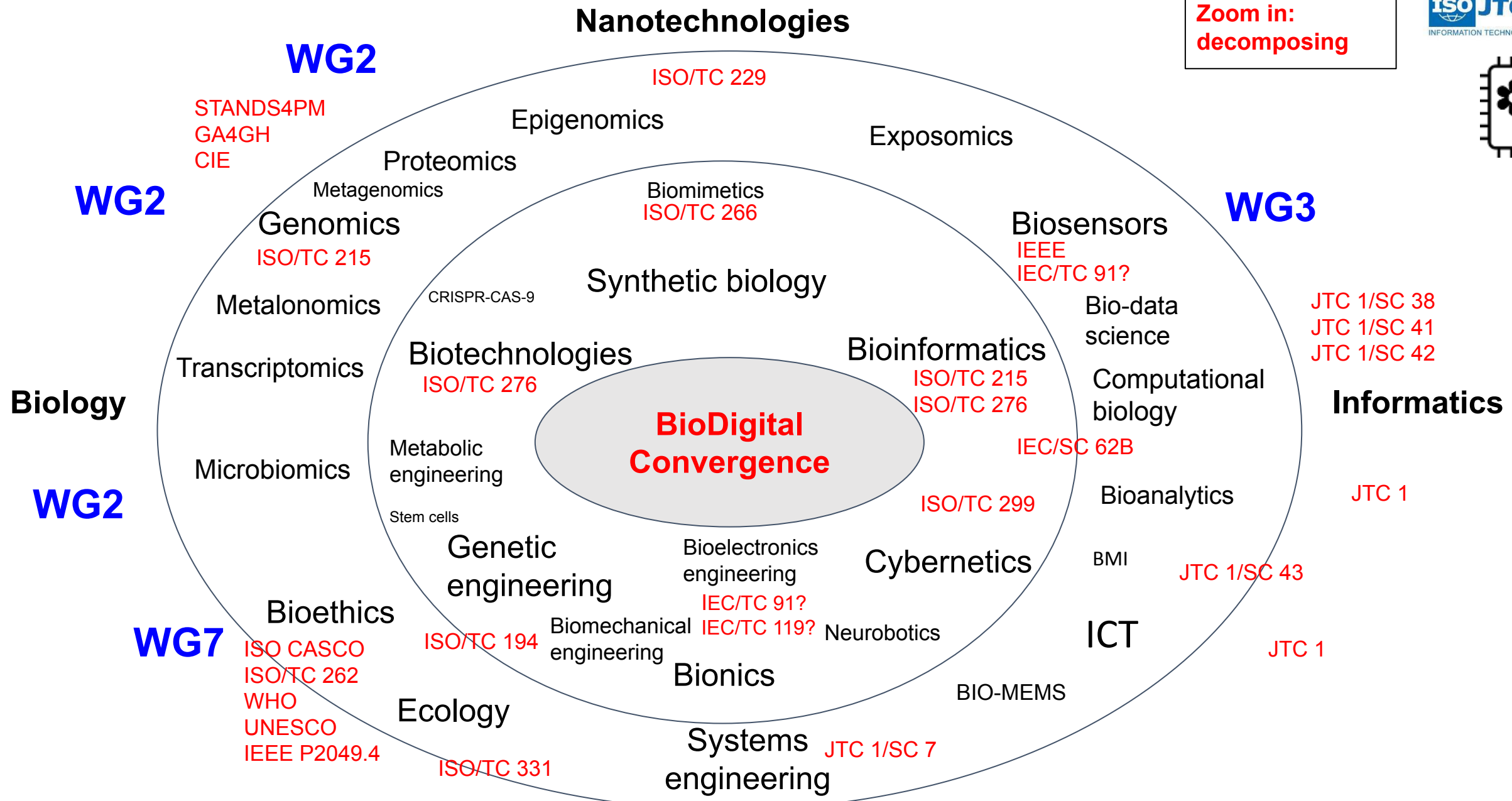

IEC, 2023. BioDigital Convergence Standardization Opportunities - Final report of the IEC Systems Evaluation Group 12 - BioDigital Convergence, in press. [Internet]. International Electrotechnical Commission; 2023. Available from: <https://www.iec.ch/bdsecamp>

Zoom out:
applications

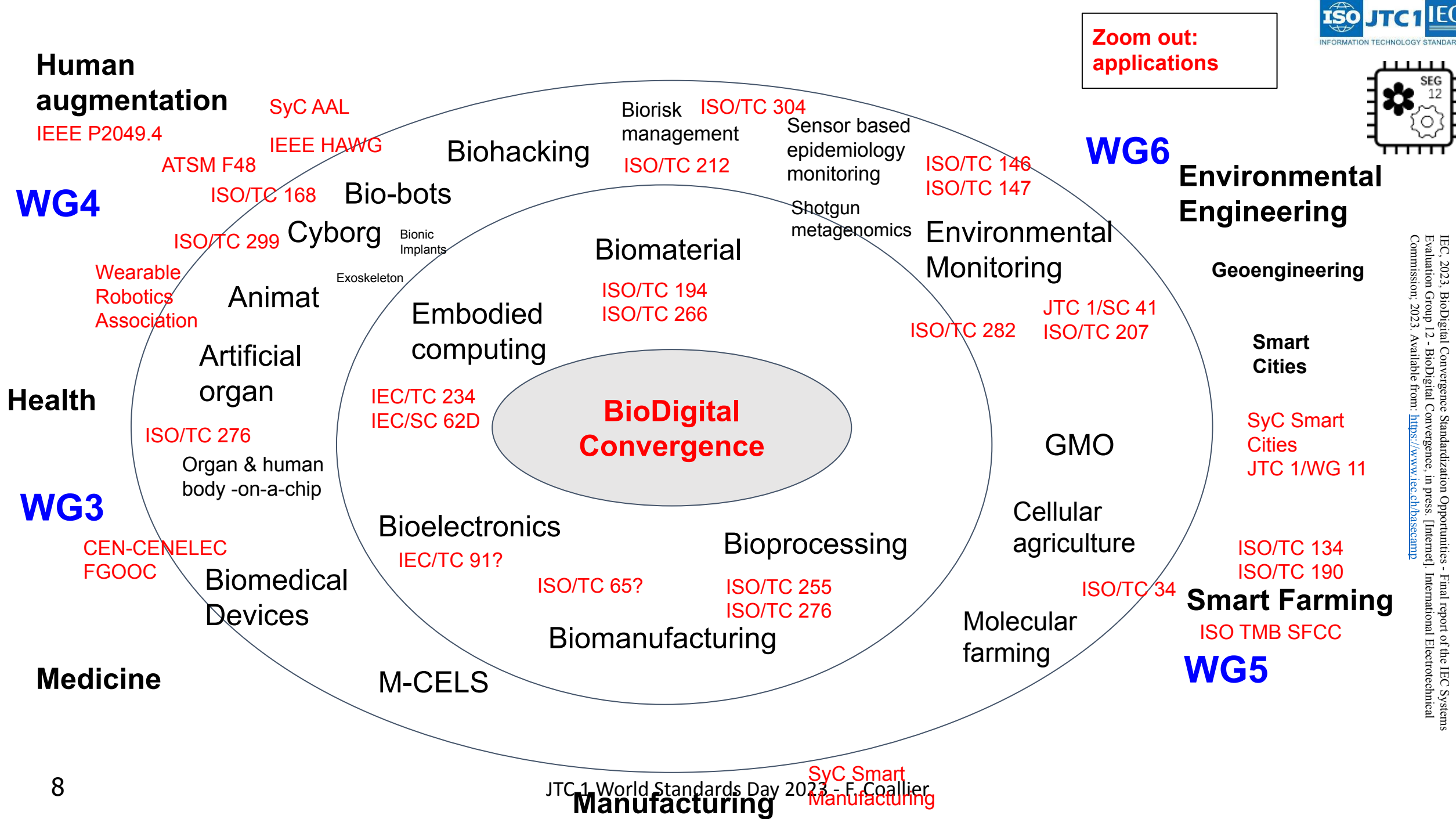
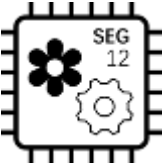

IEC, 2023. BioDigital Convergence Standardization Opportunities - Final report of the IEC Systems Evaluation Group 12 - BioDigital Convergence, in press. [Internet]. International Electrotechnical Commission; 2023. Available from: <https://www.iec.ch/bdsecamp>

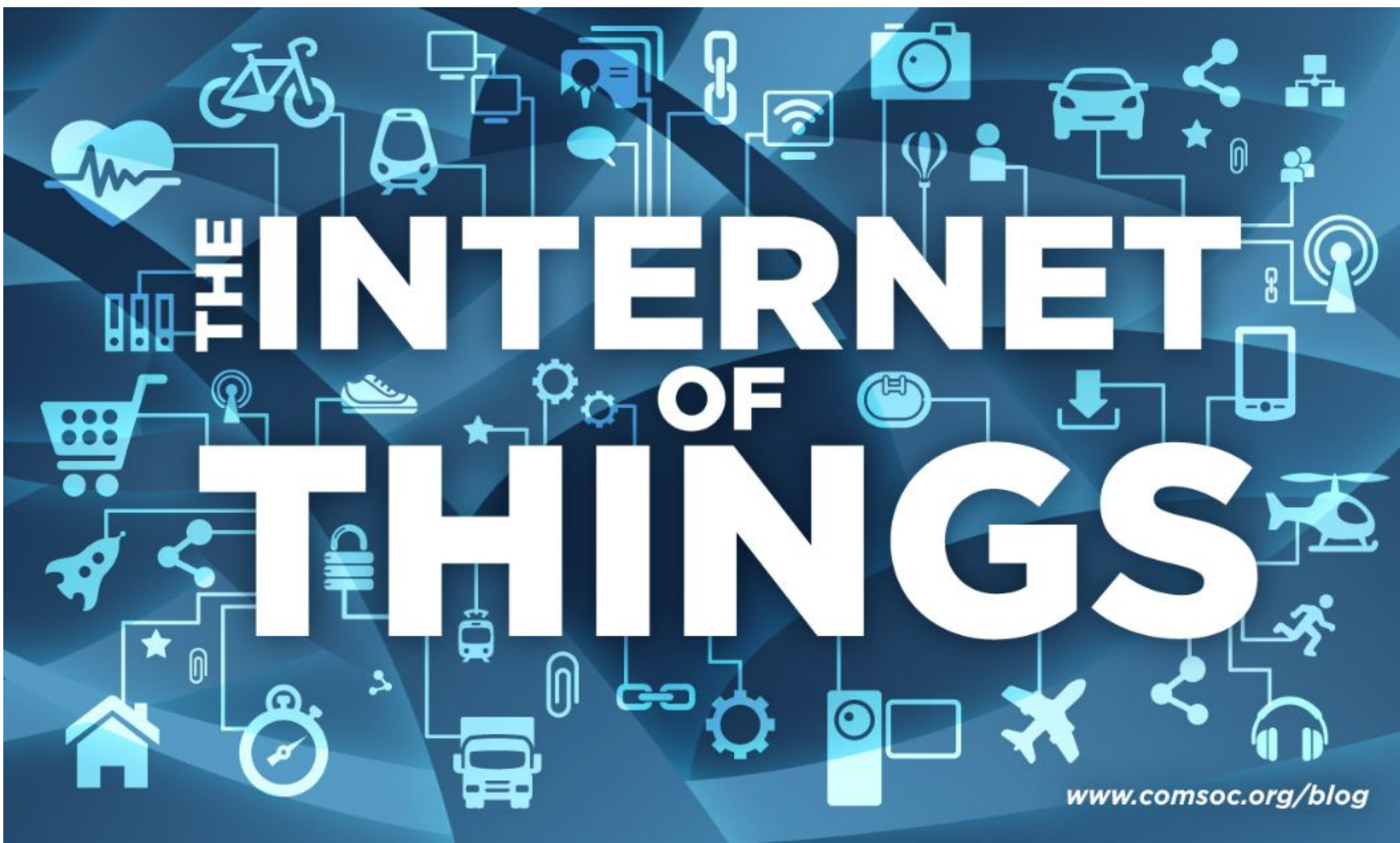

ISO/IEC Definition of IoT

3.2.8

Internet of Things

IoT

infrastructure of interconnected entities, people systems and information resources together with services which processes and reacts to information from the physical and virtual world

The Internet of Things (IoT)

- The IoT is a system concept that use many technologies that are standardized by other JTC 1 entities and SDOs ranging from networking and digital twin to cloud computing, big data, and AI.
- IoT systems are software and data intensive as well as network-centric. They can be quite complex, ranging from simple architecture to multi-tier distributed computing cyberphysical systems.
- IoT systems are key enablers of ‘Smart Everything’

A Distributed and Network centric System or System of Systems

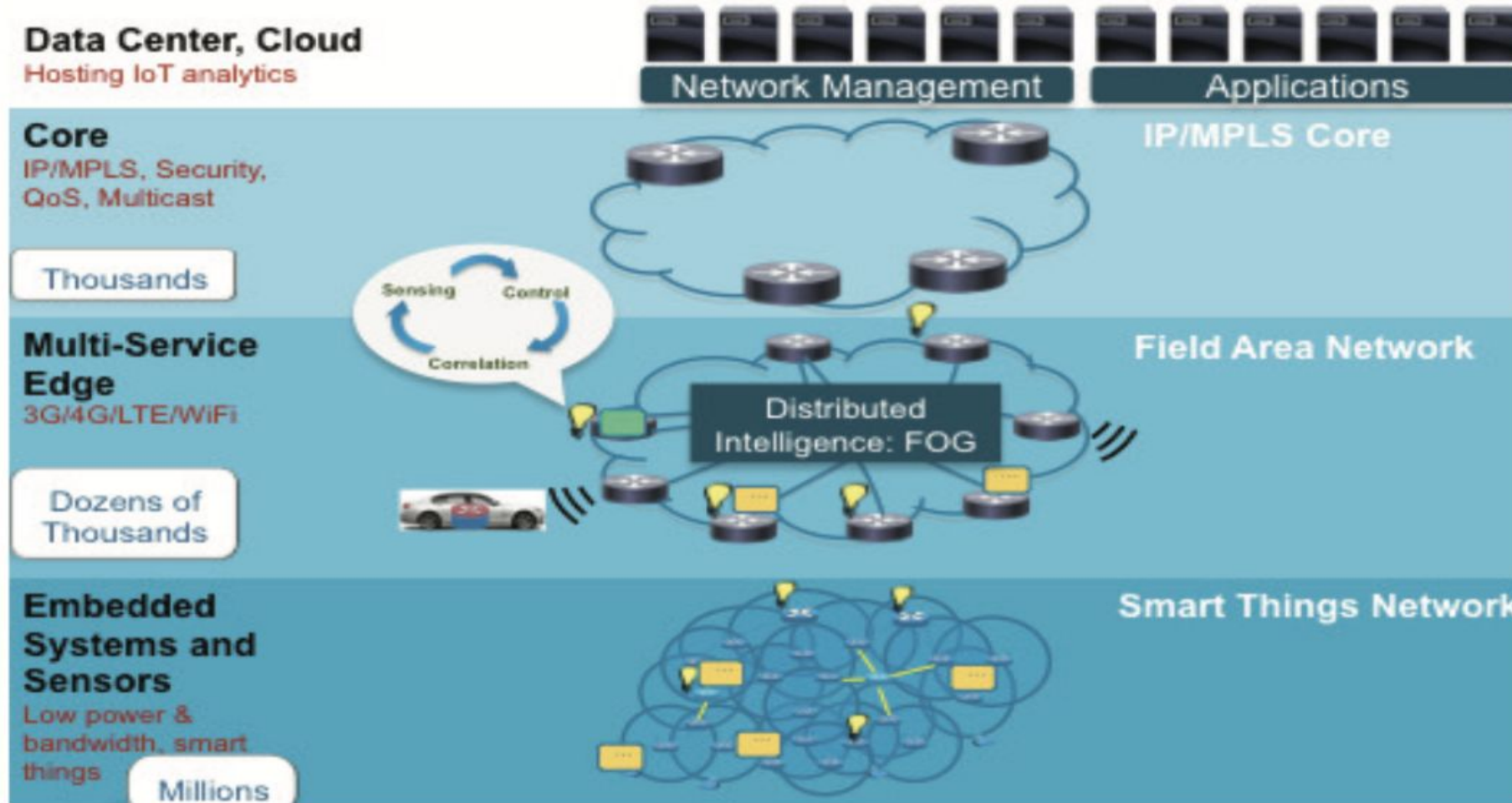

CLOUD

**EDGE/
FOG**

**Extreme
Edge/
MIST/
SWARM**

Modified from: *Fog Computing and Its Role in the Internet of Things*, Flavio Bonomi, Rodolfo Milito, Jiang Zhu, Sateesh Addepalli, Cisco Systems Inc.

+ Biosensors

sensor (3.3.29) that uses specific biochemical reactions mediated by isolated enzymes, immunosystems, tissues, organelles or whole cells to detect chemical compounds usually by electrical, thermal or optical signals

[SOURCE: Modified from IUPAC GoldBook (DOI: 10.1351/goldbook.B00663)]

[SOURCE IEC/SEG 12 Biodigital convergence - vocabulary Draft 1.1, 3.2.24]

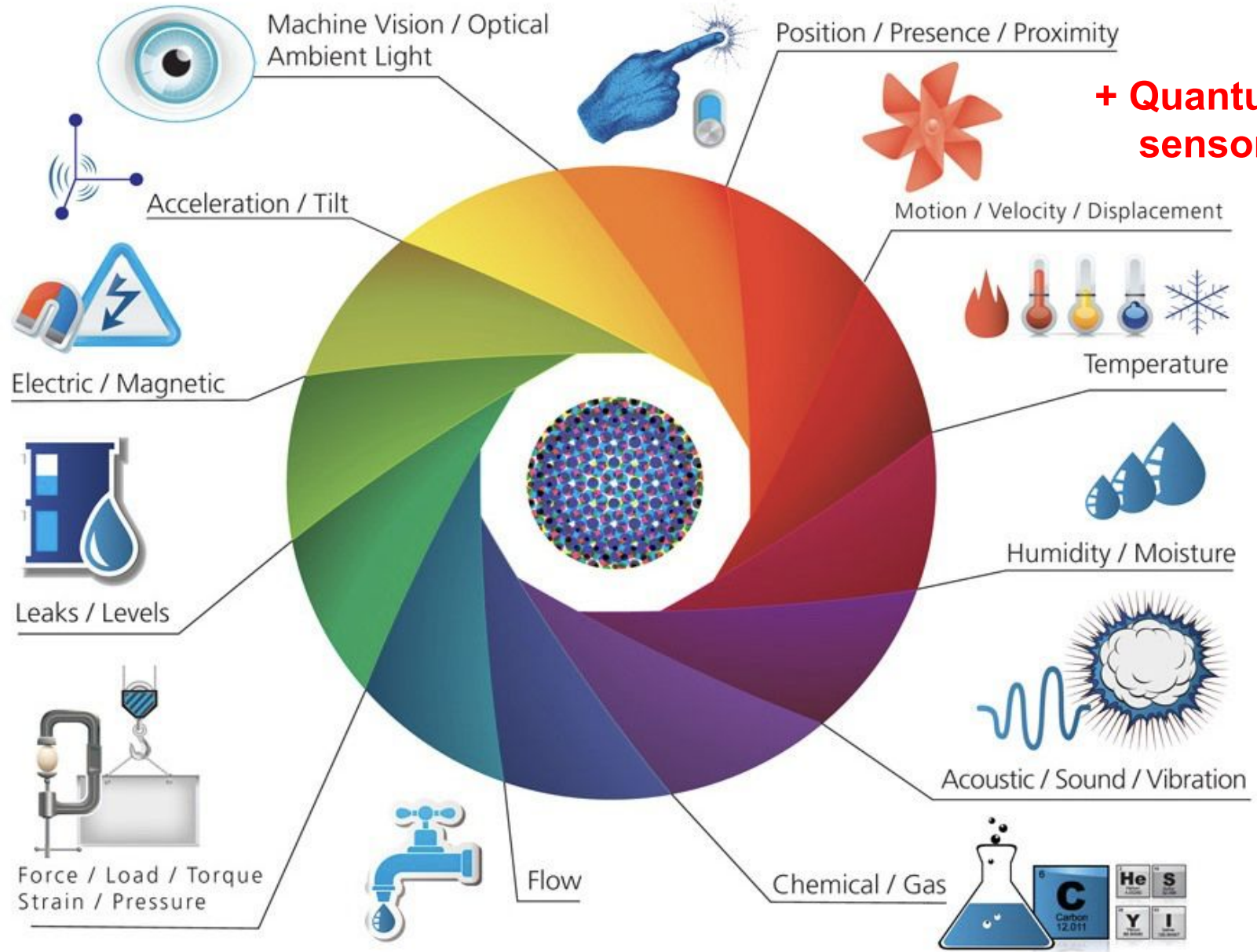

Modified from:

<https://www.postscapes.com/what-exactly-is-the-internet-of-things-infographic/>

Graphene-based Sensors in Health Monitoring

Invasive Applications

Nervous System

- ECoG
- Neural stimulation

Cardiovascular System

- ECG
- Blood glucose

Digestive System

- Gastrointestinal diagnosis

Locomotor System

- EMG
- Muscle stimulation



Non-invasive Applications

Biophysical

Electrophysiological

- EEG
- EOG
- ECG
- EMG

Kinematic

- Pulse/heart rates
- Respiration
- Phonation
- Facial expressions
- Blood pressure
- Joints movements
- Gesture
- Muscle movements

Thermometer

- Body temperature

Environmental

- Light
- Gases
- Heavy Metal

Bio-chemical

- Volatile gases
- Electrolyte
- Metabolite
- Bacteria
- Drug
- Dopamine
- Tumor markers
- Others

Sensors

3.3.1

virtual sensor

inferential sensor

logical sensor

soft sensor

software component that uses information available from other measurements and parameters to calculate an estimate of the quantity of interest

Note 1 to entry: Virtual sensors can infer the state of an object without direct access to a specific physical sensor .

Note 2 to entry: Virtual sensors are capable of capturing context data from software applications or services.

[SOURCE: Modified from https://en.wikipedia.org/wiki/Virtual_sensing, <https://www.bluefruit.co.uk/quality/virtual-sensors-for-digital-twins/> and <https://www.igi-global.com/dictionary/virtual-sensor/34977> - accessed on 2022-06-21]

IEC SEG 12 Bio-digital Convergence - Vocabulary

(SC41 N064, 2017-05)

Parameters	Wearables (Phases 1 & 2)	Implantables (Phase 4)
Information type	Position, movement, temperate, heart beat rate, pulse...	Biological data: Humoral component, blood sugar...
Shape	Watch type, bracelet type, clothes...	Super small, super thin, flexibility, conformal to human body
Power Supply	Battery-assisted	Battery-less (frequently)
Power recharge	Wired recharge	Energy harvesting
Communication type	Wi-Fi, BLE, Zigbee, NFC, 3G, 4G...	Backscattering Communication
Data Rate	X Mbps	Tens of Kbps
Networking	Various type	Only peer-to-peer
Work type	Continuously working	Activated by triggering signals
Privacy	Medium	High
Security	Medium	Very High

IoT systems are data driven

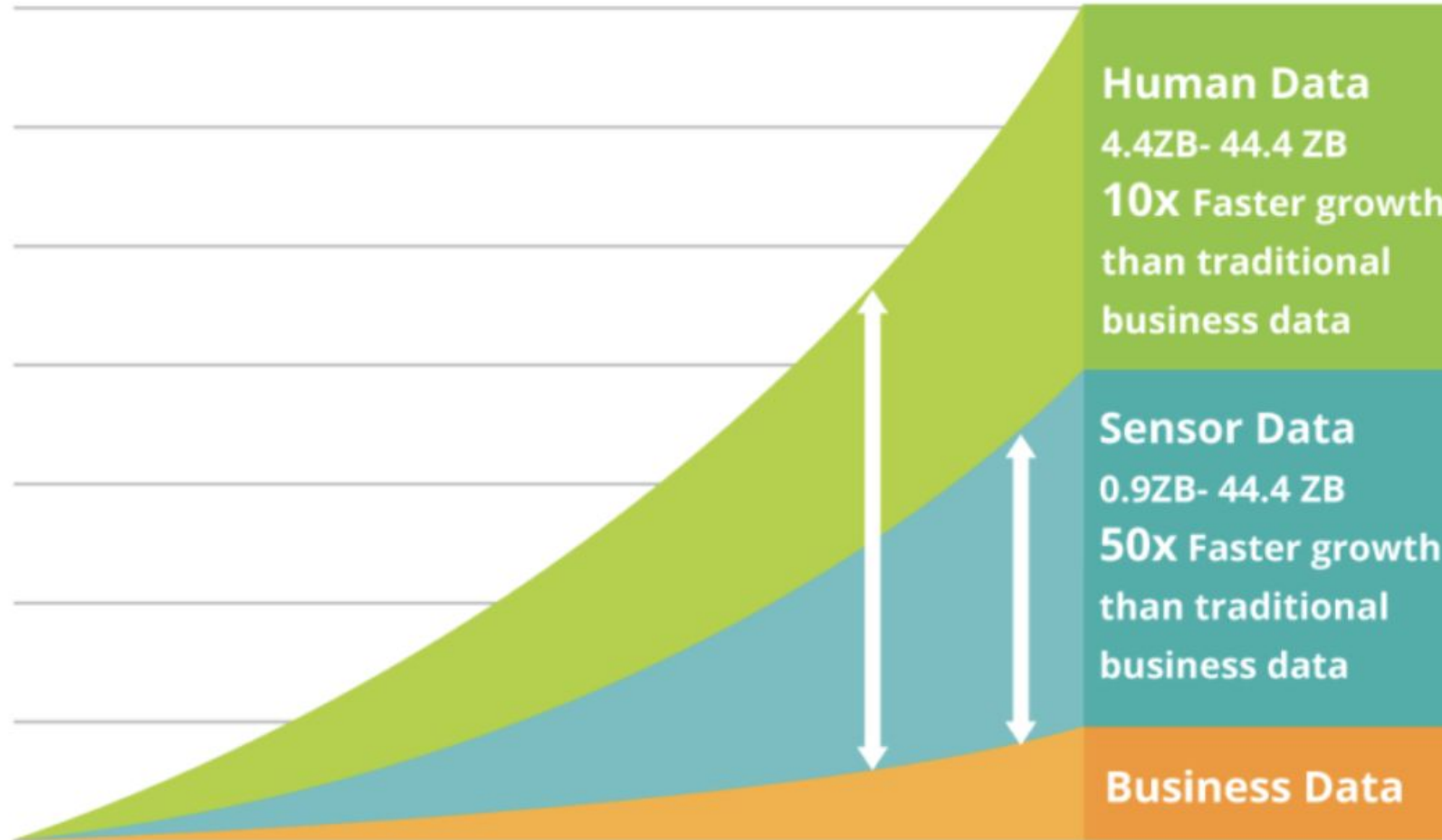

Source: Inside big data

<https://www.business2community.com/big-data/iot-big-data-ai-new-superpowers-digital-universe-01926411>

IoT systems are data driven...

GIGGO

GIGO = Garbage In Garbage Out

IN



=

OUT



<https://thestratizen.co.ke/?p=686>

See also:
<https://www.atlasobscura.com/articles/is-this-the-first-time-anyone-printed-garbage-in-garbage-out>

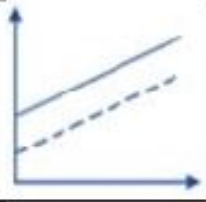
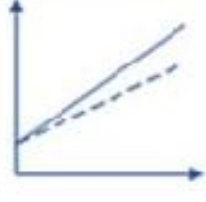
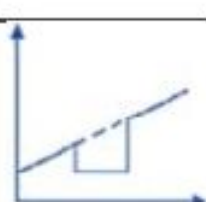
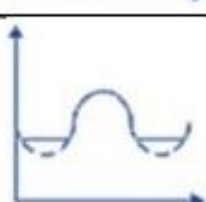
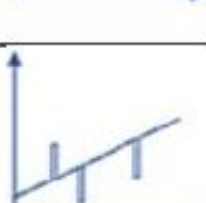
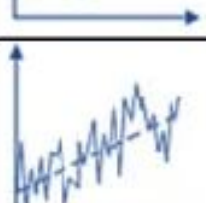
Error	Description	Example
Constant or offset error	The observations continuously deviate from the expected value by a constant offset.	
Continuous varying or drifting error	The deviation between the observations and the expected value is continuously changing according to some continuous time-dependent function (linear or non-linear).	
Crash or jammed error	The sensor stops providing any readings on its interface or gets jammed and stuck in some incorrect value.	
Trimming error	Data is correct for values within some interval, but are modified for values outside the interval. Beyond the interval, the data can be trimmed or may vary proportionally.	
Outliers error	The observations occasionally deviate from the expected value, at random points in the time domain.	
Noise error	The observations deviate from the expected value stochastically in the value domain and permanently in the temporal domain.	

KEY CHALLENGES WITH TIME SERIES DATA QUALITY

<https://medium.com/hashmapinc/discovering-the-keys-to-solving-for-data-quality-analysis-in-streaming-time-series-datasets-8d8780fa7ecb>

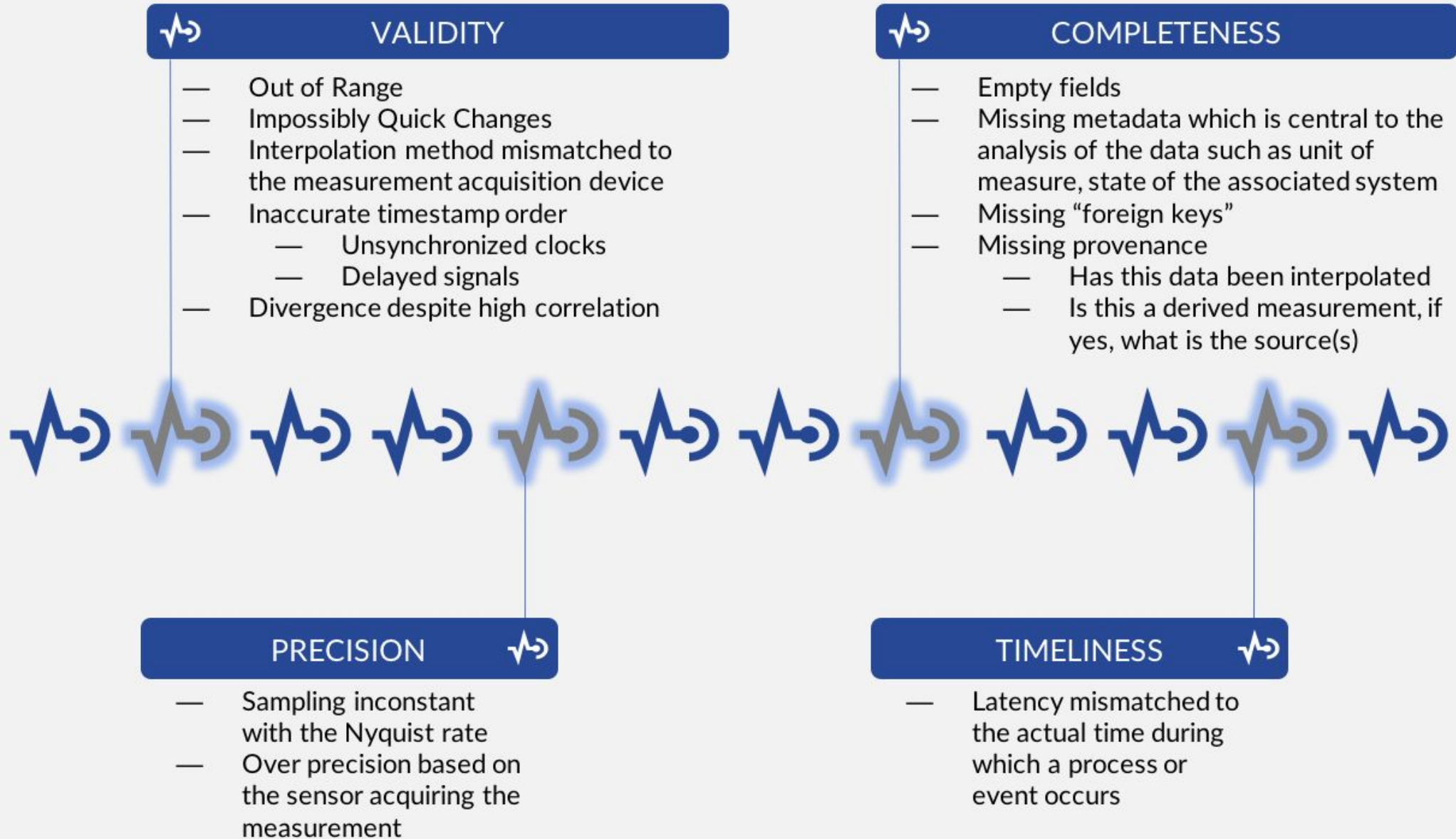

'Technologies' found in IoT systems

- IoT architectures (JTC 1/SC 41)
- Sensors, actuators, tags (IEC/TC 72, JTC 1/SC 31,..)
- Networks... (JTC 1/SC 6, IEC/SyC COMM, ITU-T,..)
- Cloud computing (JTC 1/SC 38)
- Big Data (JTC 1/SC 42)
- AI (JTC 1/SC42)
- Digital Twin (JTC 1/SC 41)
- Trustworthiness and Cybersecurity (JTC 1/WG13 & JTC 1/SC 27)
- Data governance (JTC 1/SC 40)
- Data management (JTC 1/SC 32, ISO/TC 184)
- Software and Systems Engineering (JTC 1/SC7)
-

Hype Cycle for the Internet of Things, 2020

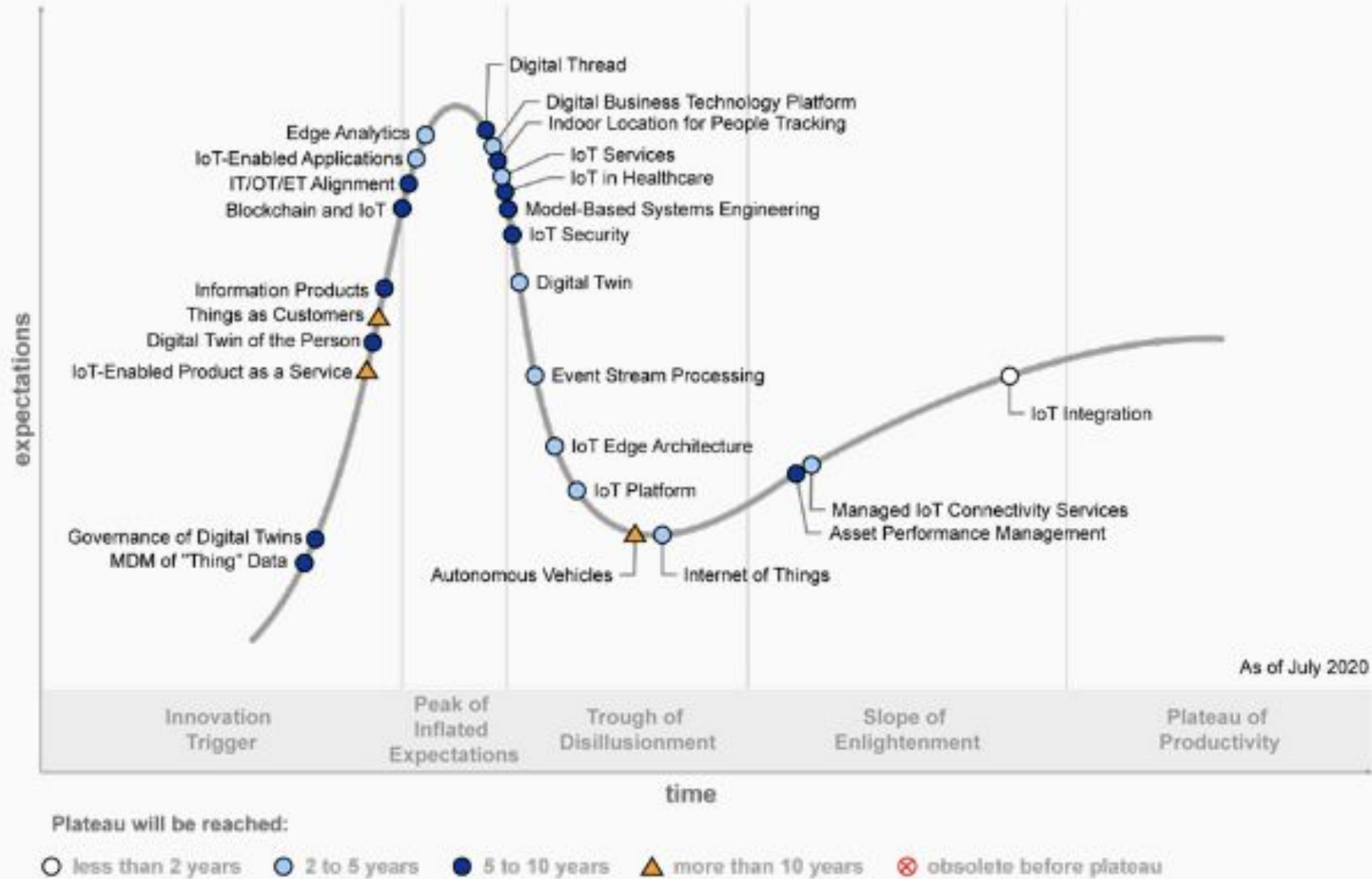

Source: Gartner
ID: 441743

What does IoT bring?

Among many things:

The ability for an entity (human or machine) to make a decision using ‘real-time’ and historical **data** (patterns,..) and act on it.

- IoT systems include data processing and analytical applications.
- Some systems incorporate also Digital Twin technology.

IoT systems are key enablers of 'Smart Everything'



SMART
EVERYTHING
EVERYWHERE

<https://www.facebook.com/see40/>



<https://www.iot-now.com/2017/09/25/67259-everything-can-smart-key-traits-newest-smart-cities-part-1/>

What you can do with IoT in the healthcare industry



Remote patient monitoring



Telehealth



Assisted living



Hospital asset management



Improved drug management



Hand hygiene compliance



Chronic disease management



Behavior modification

<http://www.softwebiot.com/iot-use-cases/how-iot-solutions-can-change-healthcare-organization/>

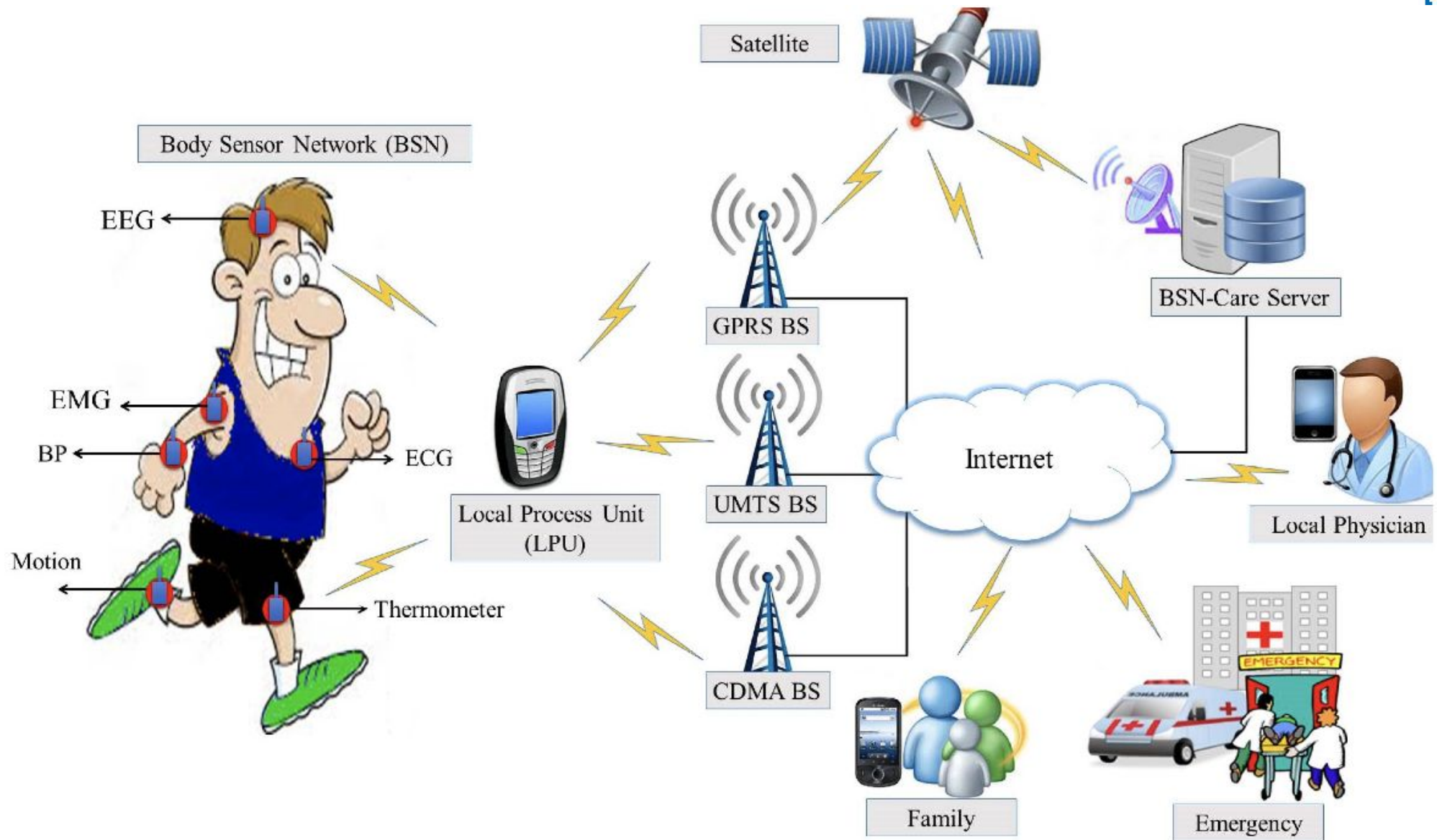

Prosanta Gope, Tzonelih Hwang, BSN-Care: A Secure IoT-Based Modern Healthcare System Using Body Sensor Network, IEEE SENSORS JOURNAL, VOL. 16, NO. 5, MARCH 1, 2016, <https://www.semanticscholar.org/paper/BSN-Care-A-Secure-IoT-Based-Modern-Healthcare-Syst-Gope-Hwang/415aed0291fa7c9a048792805a1ba1fe8438f984>

Smart healthcare

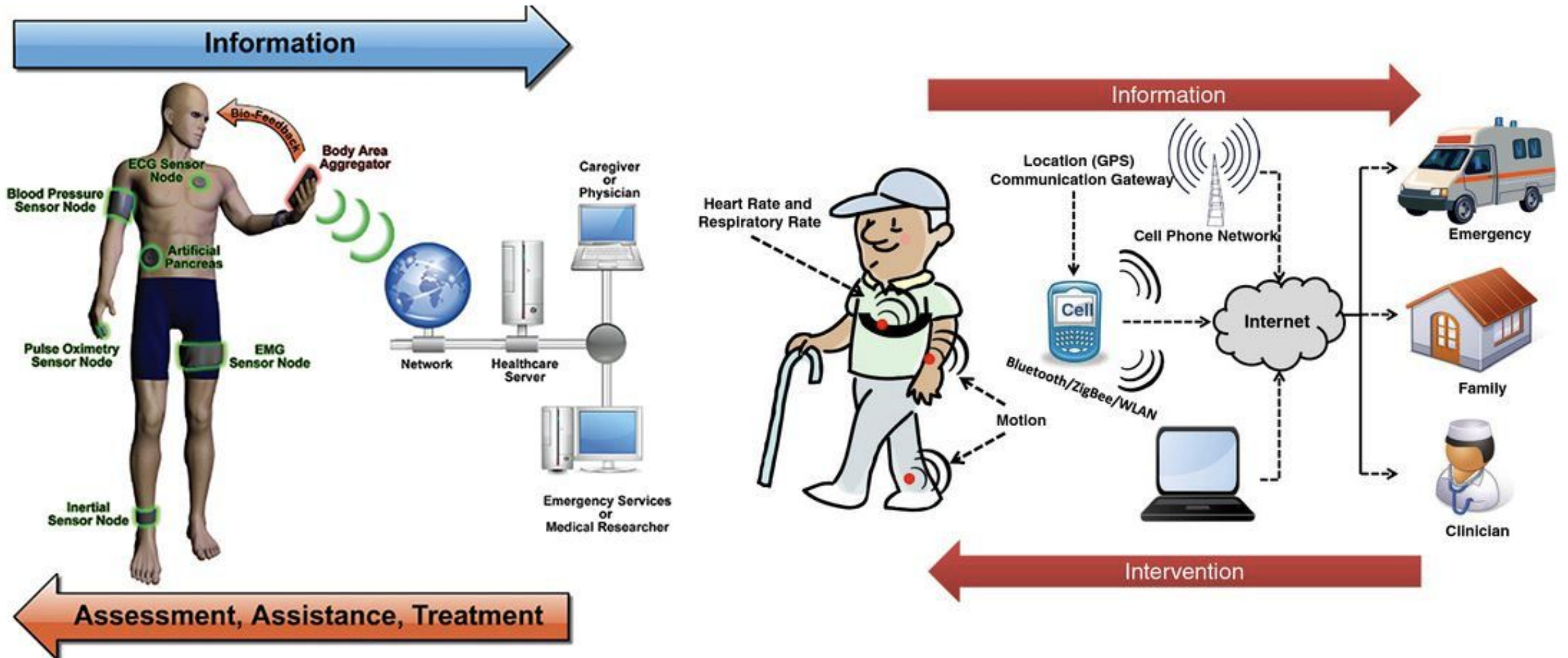

<http://www.innovativeideas.com/2017/02/secured-smart-healthcare-monitoring.html>

ACTUATORS

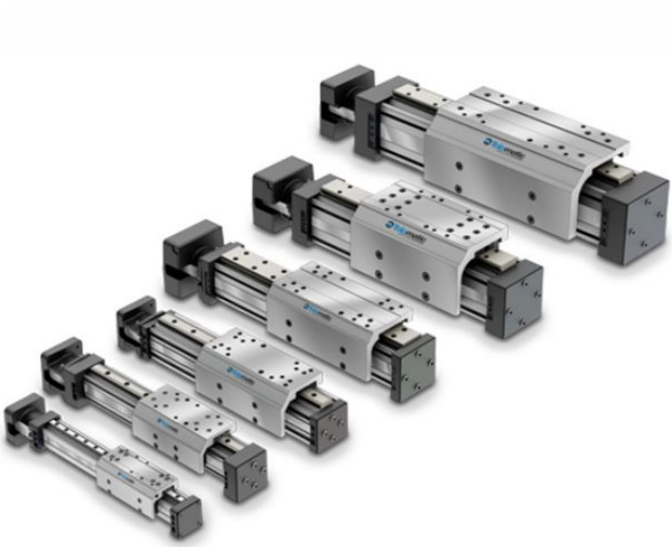
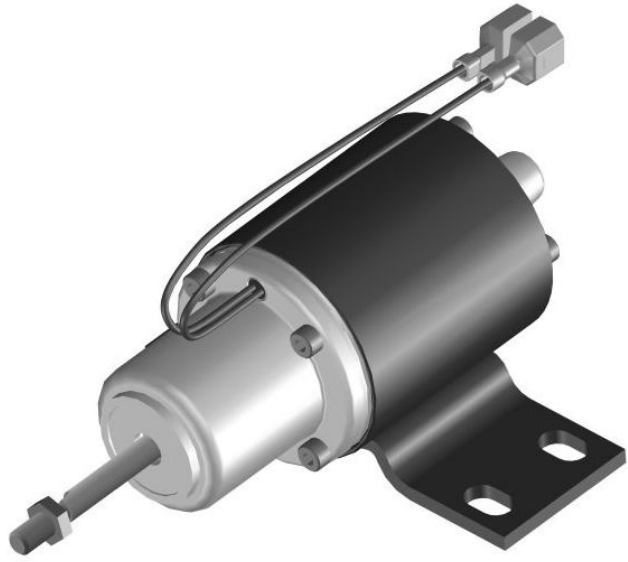

<https://parasam.me/2016/05/19/iot-internet-of-things-a-short-series-of-observations-pt-2-sensors-actuators-infrastructure/>

Wireless Implantable Medical Devices

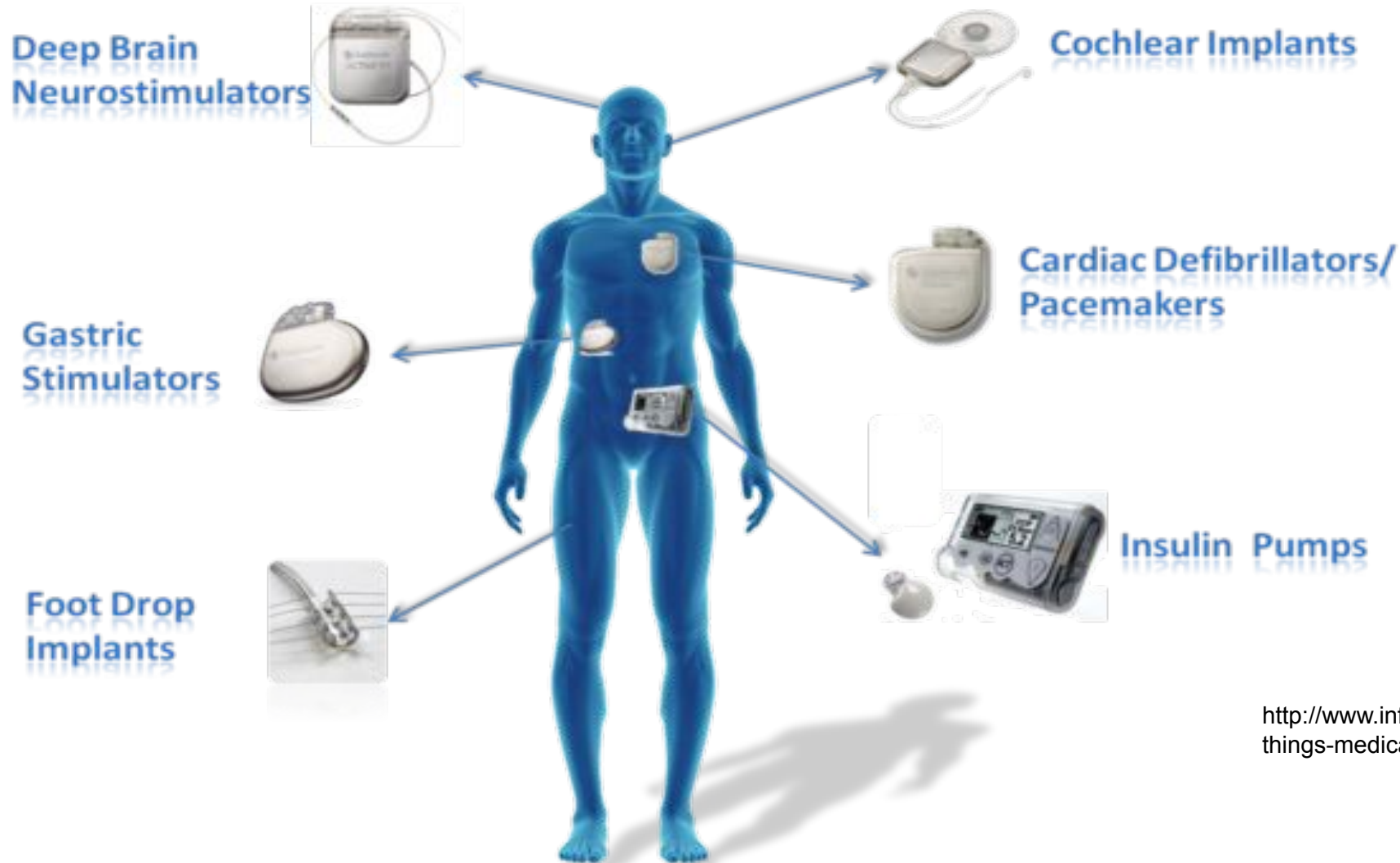

<http://www.infiniteinformationtechnology.com/internet-things-medical-device-industry>

A composite graphic illustrating the convergence of IT and OT. It features two overlapping globes: a blue one on the left and a yellow one on the right. The background is a dark space with a network of glowing blue and orange lines, and various icons representing technology and industry. The text 'IT/OT CONVERGENCE' is centered in large white letters.

IT/OT CONVERGENCE

OT

IT

Convergence IT / OT

IT/OT convergence is the integration of information technology (IT) systems used for data-centric computing with operational technology (OT) systems used to monitor events, processes and devices and make adjustments in enterprise and industrial operations.

IT and OT Convergence –a view

The evolution of IT-OT convergence

NOTE: Dates are when those mainly evolving technologies were introduced.

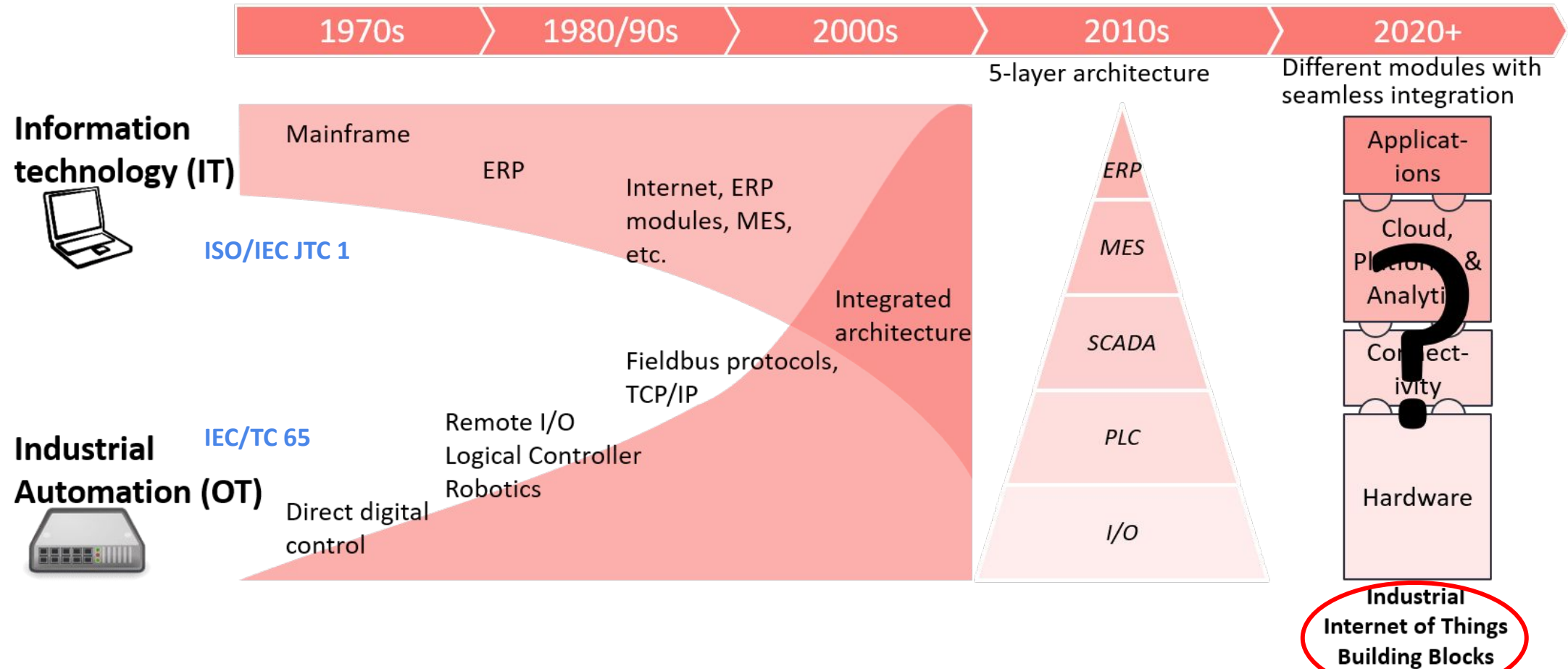

ERP = Enterprise Resource Planning MES = Manufacturing Execution System SCADA = Supervisory Control and Data Acquisition PLC = Programmable Logic Controller I/O = Input/Output signals
Source: IoT Analytics

Modified from:
<https://iot-analytics.com/5-industrial-connectivity-trends-driven-the-it-of-convergence/>
<http://www.forbes.com/sites/louiscolombus/2016/12/03/industrial-analytics-based-on-internet-of-things-will-revolutionize-manufacturing/#59fa85bc49ac>

An Hospital is an industrial facility

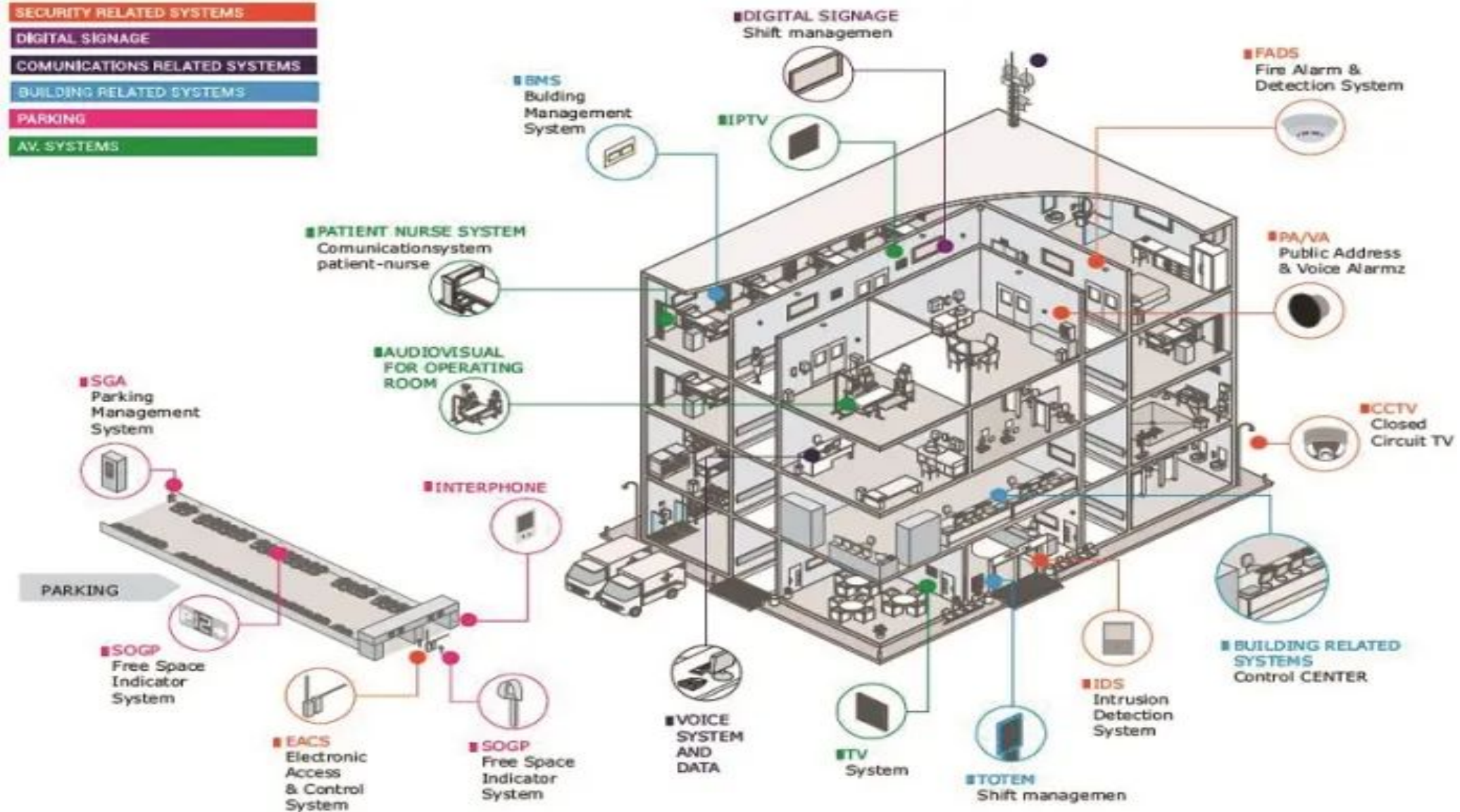

<https://www.coolingindia.in/integrated-bms-for-healthcare-buildings/>

IoMT

The Internet of Medical Things (IoMT) is the network of medical devices, hardware infrastructure, and software applications used to connect healthcare information technology.

Sometimes referred to as IoT in healthcare, IoMT allows wireless and remote devices to securely communicate to allow rapid and flexible analysis of medical data.

Modified from <https://ordr.net/article/what-is-iomt/>

IoMT

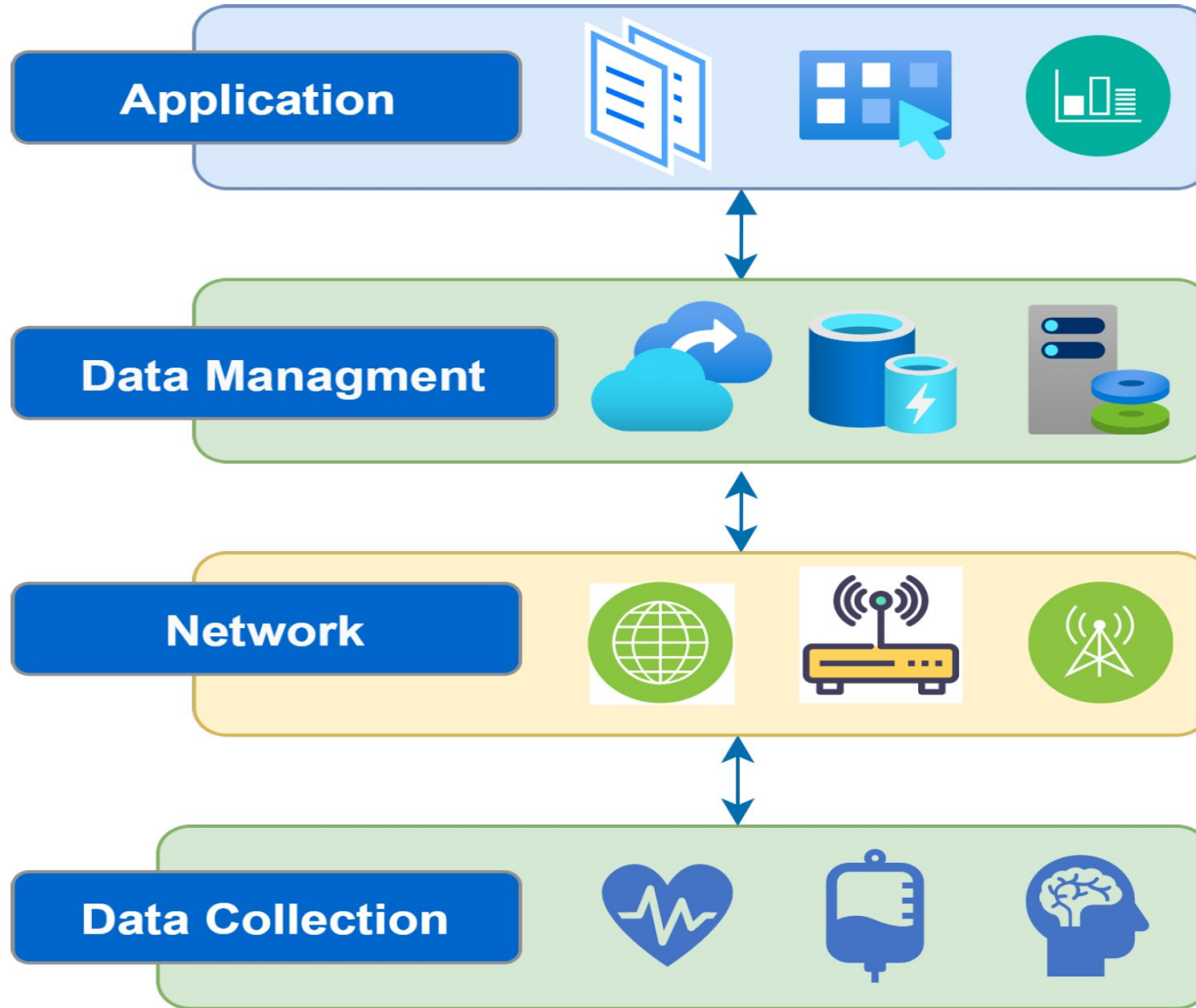

Alsaeed, Norah, and Farrukh Nadeem. 2022. "Authentication in the Internet of Medical Things: Taxonomy, Review, and Open Issues" *Applied Sciences* 12, no. 15: 7487. <https://doi.org/10.3390/app12157487>

IoMT

Monitoring Applications

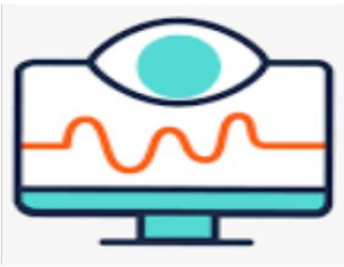

Diagnostic Applications

Therapeutic Applications



Rehabilitation Applications

Alsaeed, Norah, and Farrukh Nadeem. 2022. "Authentication in the Internet of Medical Things: Taxonomy, Review, and Open Issues" *Applied Sciences* 12, no. 15: 7487. <https://doi.org/10.3390/app12157487>

Smarter Healthcare

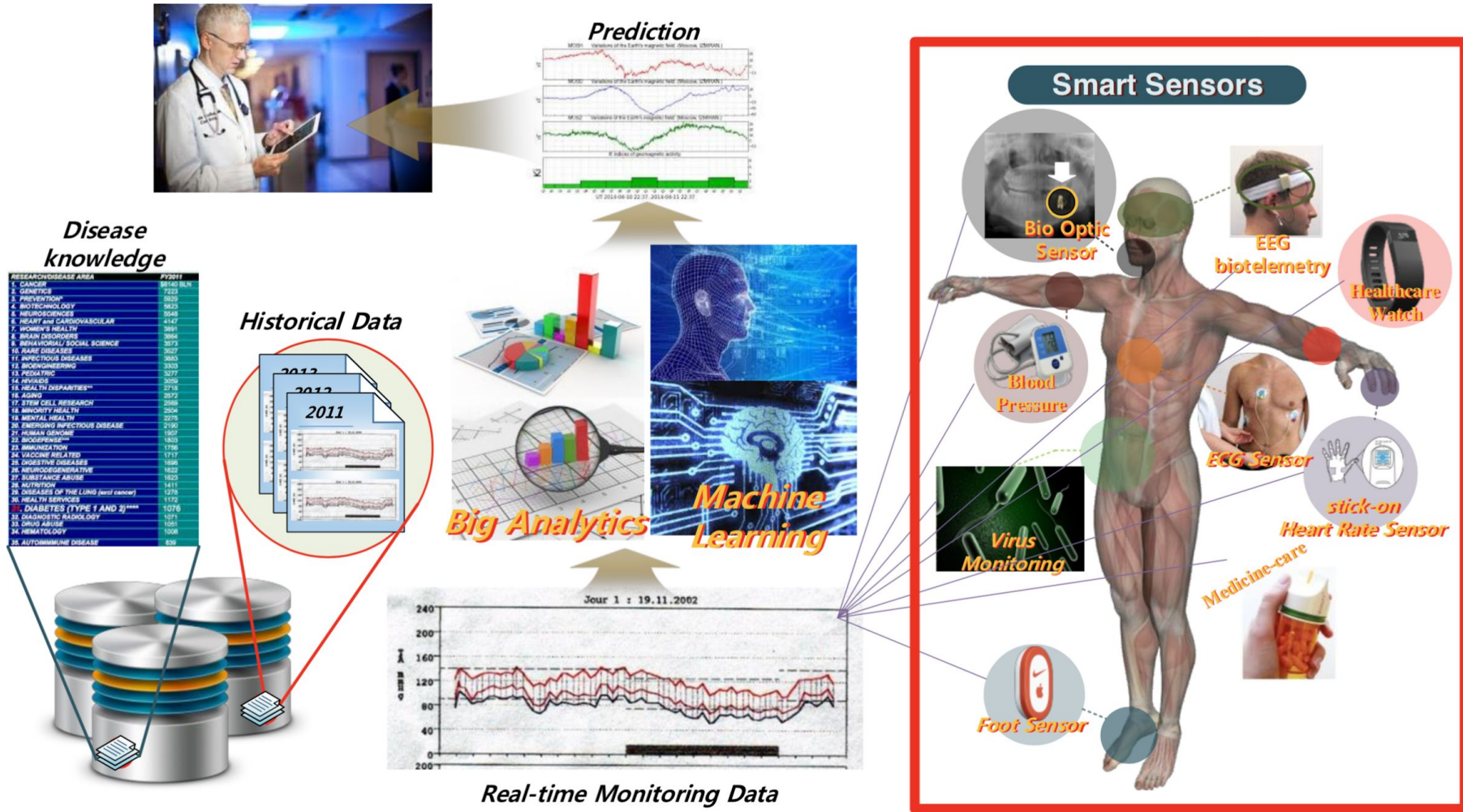

SNAIL Project for IoT Connectivity, Minkeun Ha, Jun 25, 2014, Auto - ID Labs, KAIST
https://www.slideshare.net/gatordkim/snail-project-for-iot-connectivity?from_action=save

Digital Twin

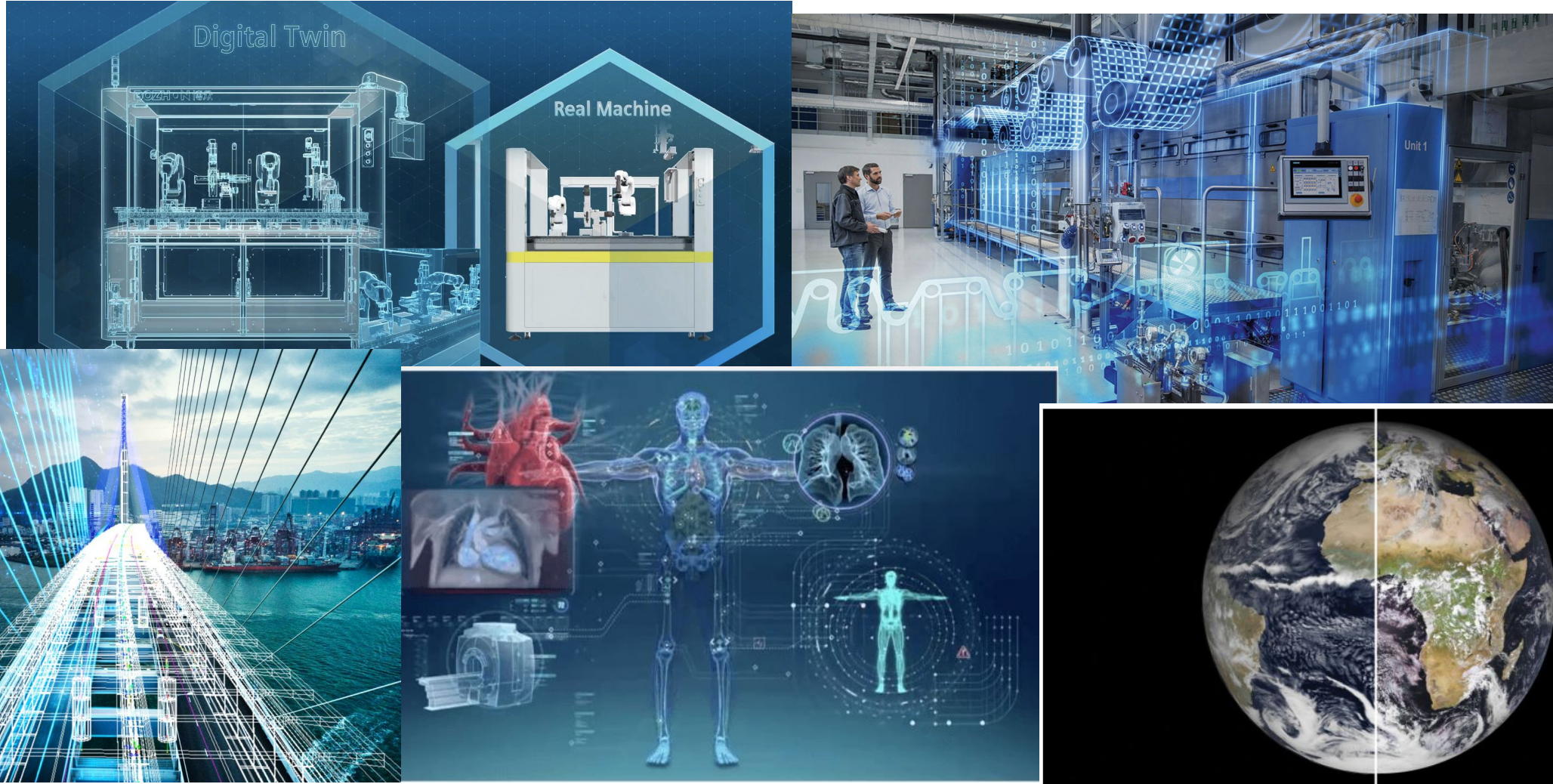

<https://www.plm.automation.siemens.com/global/cz/webinar/digital-twin-in-manufacturing/68561>

<https://medium.com/@yashbajaj900/digital-twin-application-in-healthcare-69bf4c0f87e7>

<https://www.cadalyt.com/collaboration/digital-twin/road-and-bridge-digital-twins-action-four-case-studies-75827>

<https://www.sciencemag.org/news/2020/10/europe-building-digital-twin-earth-revolutionize-climate-forecasts>

At 1-kilometer resolution, a European climate model (left) is nearly indistinguishable from reality (right). (LEFT TO RIGHT) ECMWF, © EUMETSAT

ISO/IEC Definition of Digital Twin

3.1.1

digital twin

DTw

digital representation(3.1.7) of a target *entity*(3.1.2) with data connections that enable convergence between the physical and digital states at an appropriate rate of synchronization

Note 1 to entry: Digital twin has some or all of the capabilities of connection, integration, analysis, simulation, visualization, optimization, collaboration, etc.

Note 2 to entry: Digital twin can provide an integrated view throughout the life cycle of the target entity.

Digital Twin - in brief

According to Gartner and Deloitte, a digital twin as a digital representation of a real-world entity or system. It is an evolving digital profile of the historical and current behavior of a physical object or process.

The implementation of a digital twin is an encapsulated software object or model that mirrors a unique physical object, process, organization, person or other abstraction. The digital twin is thus based on massive, cumulative, real-time, real-world data measurements across an array of dimensions.

Data from multiple digital twins can be aggregated for a composite view across a number of real-world entities, such as a ship, a bridge, a building, a factory, a supply-chain or a city.

Mirroring is done through synchronization using data streams. The data streams are generated by sensors, but also transactions and other sources (virtual sensors).

Digital Twin (DT) is an enabler Smart Everything, being based on measurements that creates an evolving profile of the entity or system in the digital world, it provides important insights on system performance, leading to actions in the real world such as a change in system and process design, or optimizing business performance.

Digital Twin Technologies

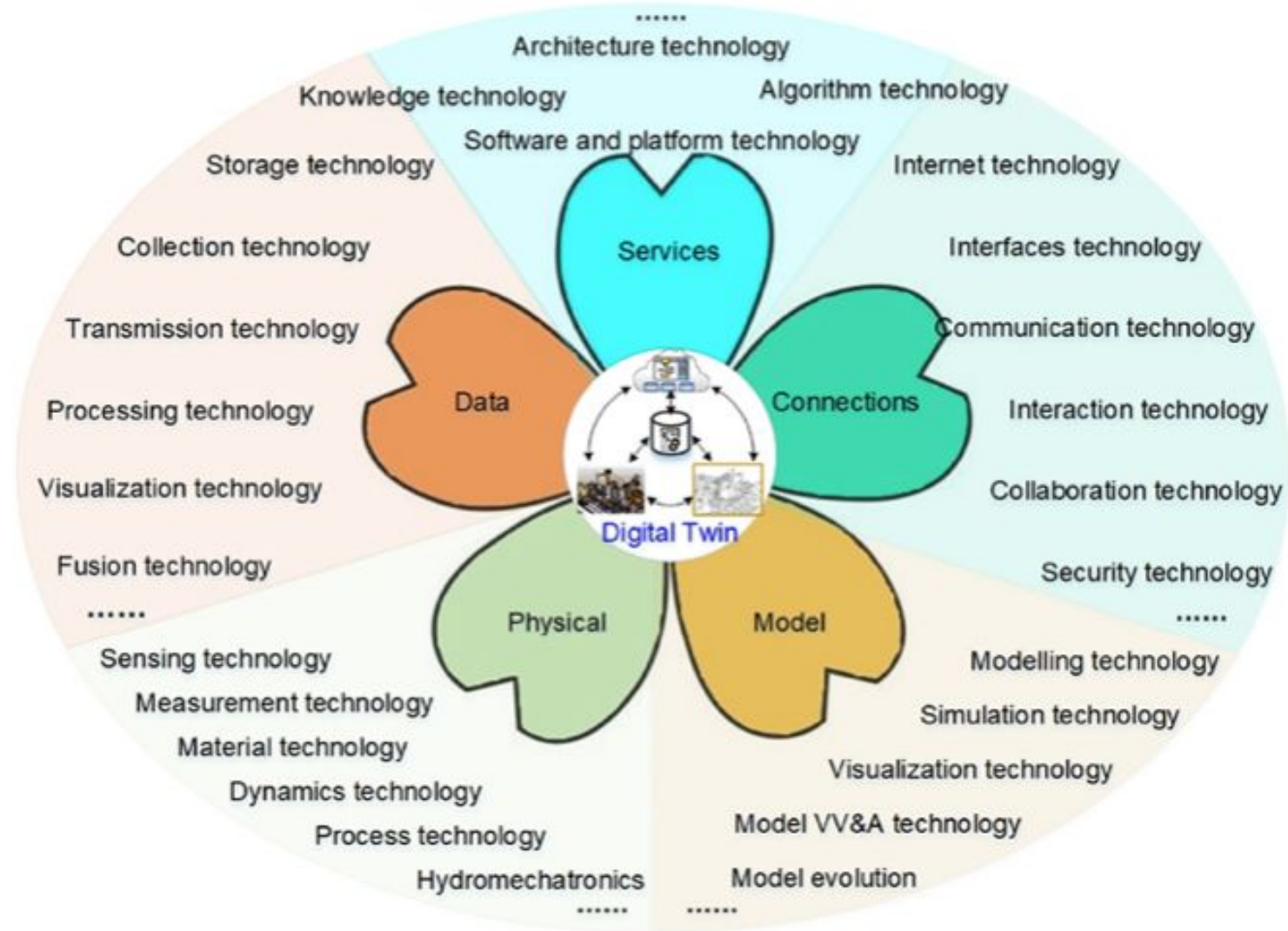

Fig. 6. Framework of enabling technologies for digital twin.

Qinglin Qi, Fei Tao, Tianliang Hu, Nabil Anwer, Ang Liu, Yongli Wei, Lihui Wang, A.Y.C. Nee, Enabling technologies and tools for digital twin, Journal of Manufacturing Systems, 2019,

ISSN 0278-6125,

<https://doi.org/10.1016/j.jmsy.2019.10.001>.

(<http://www.sciencedirect.com/science/article/pii/S027861251930086X>)

Digital Twin Modeling

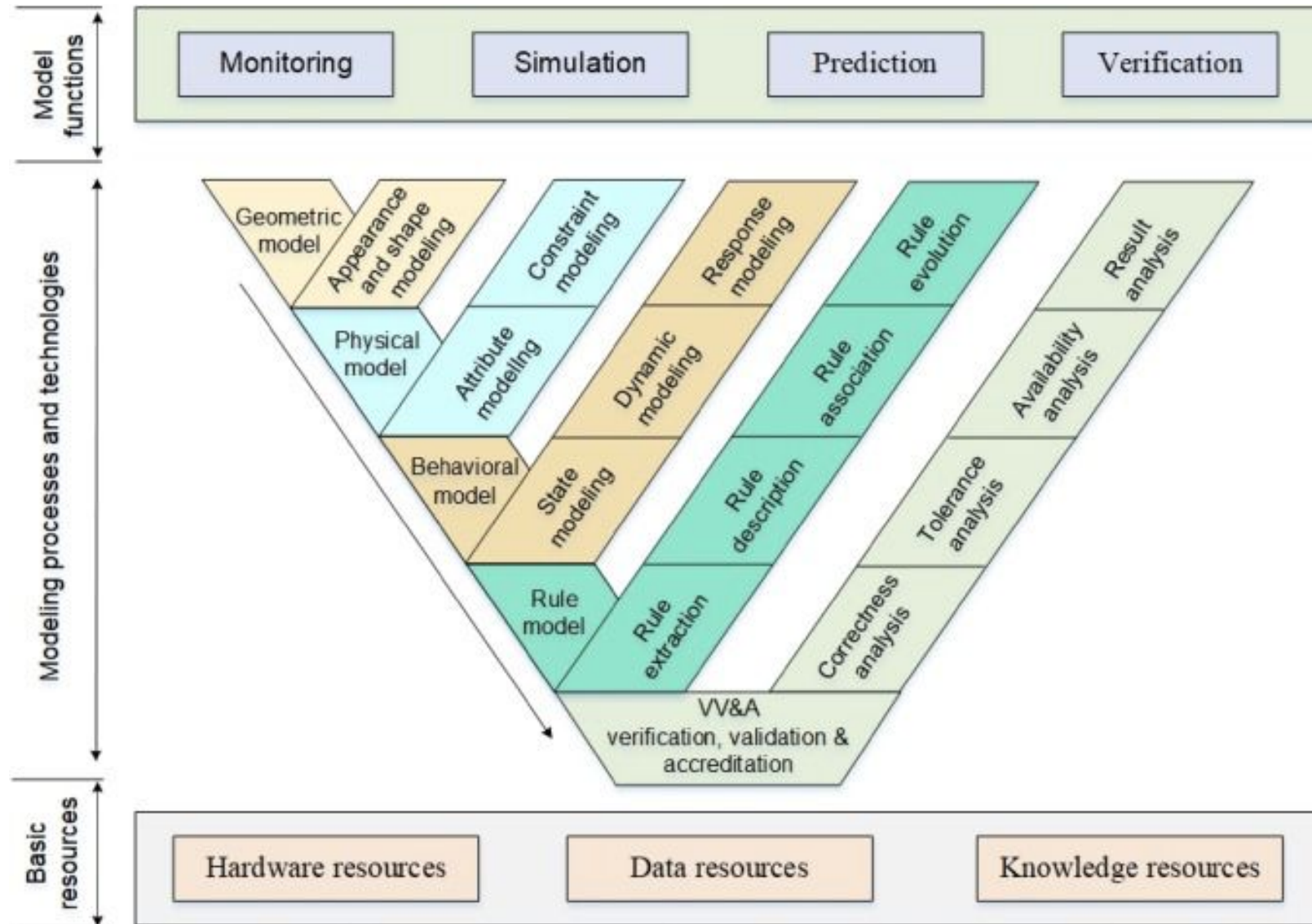

Qinglin Qi, Fei Tao, Tianliang Hu, Nabil Anwer, Ang Liu, Yongli Wei, Lihui Wang, A.Y.C. Nee, Enabling technologies and tools for digital twin, Journal of Manufacturing Systems, 2019,

ISSN 0278-6125,

<https://doi.org/10.1016/j.jmsy.2019.10.001>.

(<http://www.sciencedirect.com/science/article/pii/S027861251930086X>)

5 (data) Vs of Digital Twins

- **Volume:** the volume of data aggregated in a digital twin varies considerably depending on the mirrored physical entity, but quite a few physical entities are bound to generate a significant amount of data;
- **Velocity:** the shadowing of a physical entity again varies considerably but here again can have a significant “change rate”;
- **Variety:** a digital twin may aggregate different streams of data (like the actual modelling of the entity –static-, the operation data –dynamic-, the context data -static and dynamic-), and in addition it can harvest data from other interacting or connected digital twins;
- **Veracity:** internal and external functionalities can authenticate data and ensure their veracity;
- **Value:** digital twins are a way to create value in the digital transformation.

Human Digital Twin

Medical Research



<https://www.verywellhealth.com/digital-twin-computer-model-of-patients-5120469>

Modeling workflow for personalized medicine (© EU-STANDS4PM)

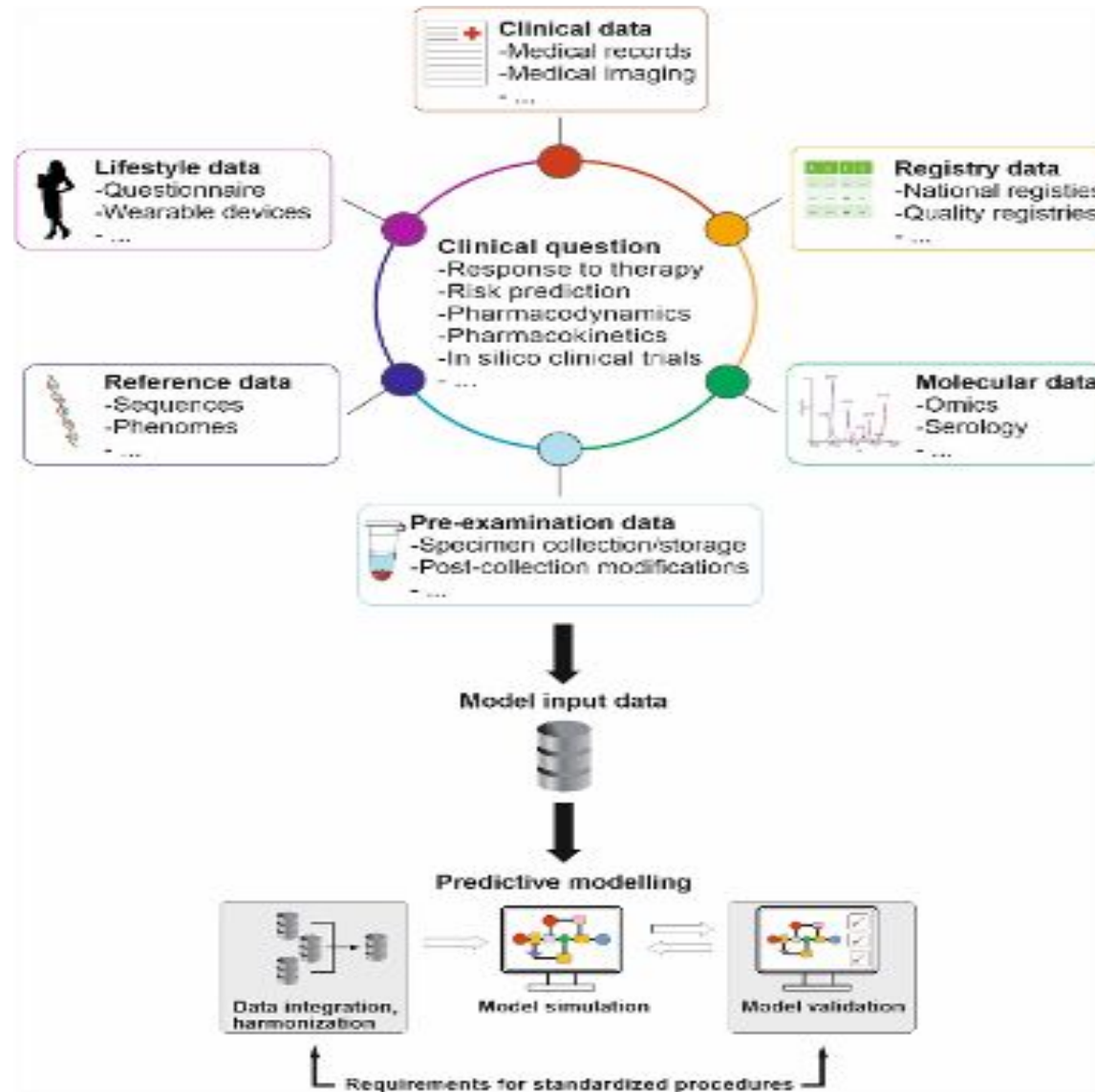

IEC, 2023, BioDigital Convergence Standardization Opportunities - Final report of the IEC Systems Evaluation Group 12 - BioDigital Convergence, in press. [Internet]. International Electrotechnical Commission; 2023. Available from: <https://www.iec.ch/basecamp>

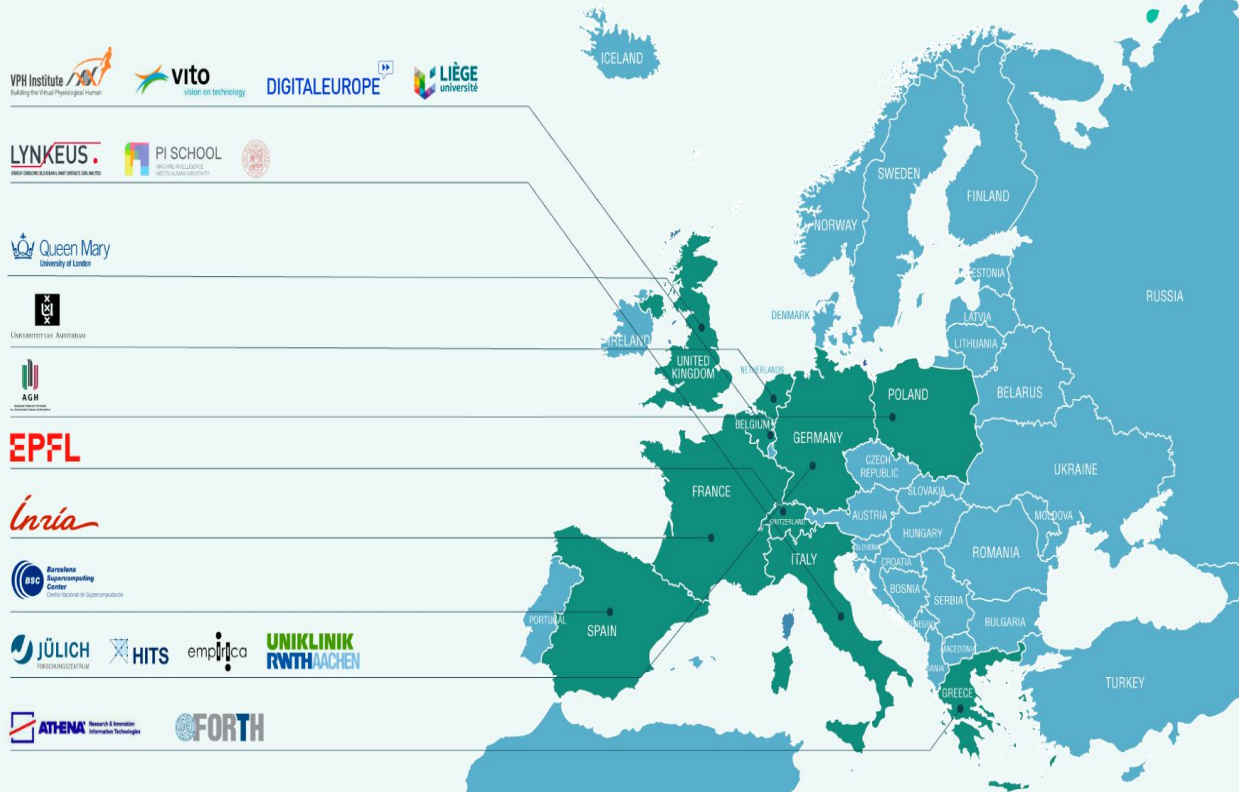

<https://www.edith-csa.eu>

Environmental monitoring



the systematic sampling of air, water, soil, and biota in order to observe and study the environment, as well as derive knowledge from this process.

<https://www.slideshare.net/ShivangiSomvanshi/environmental-monitoring-61608986>

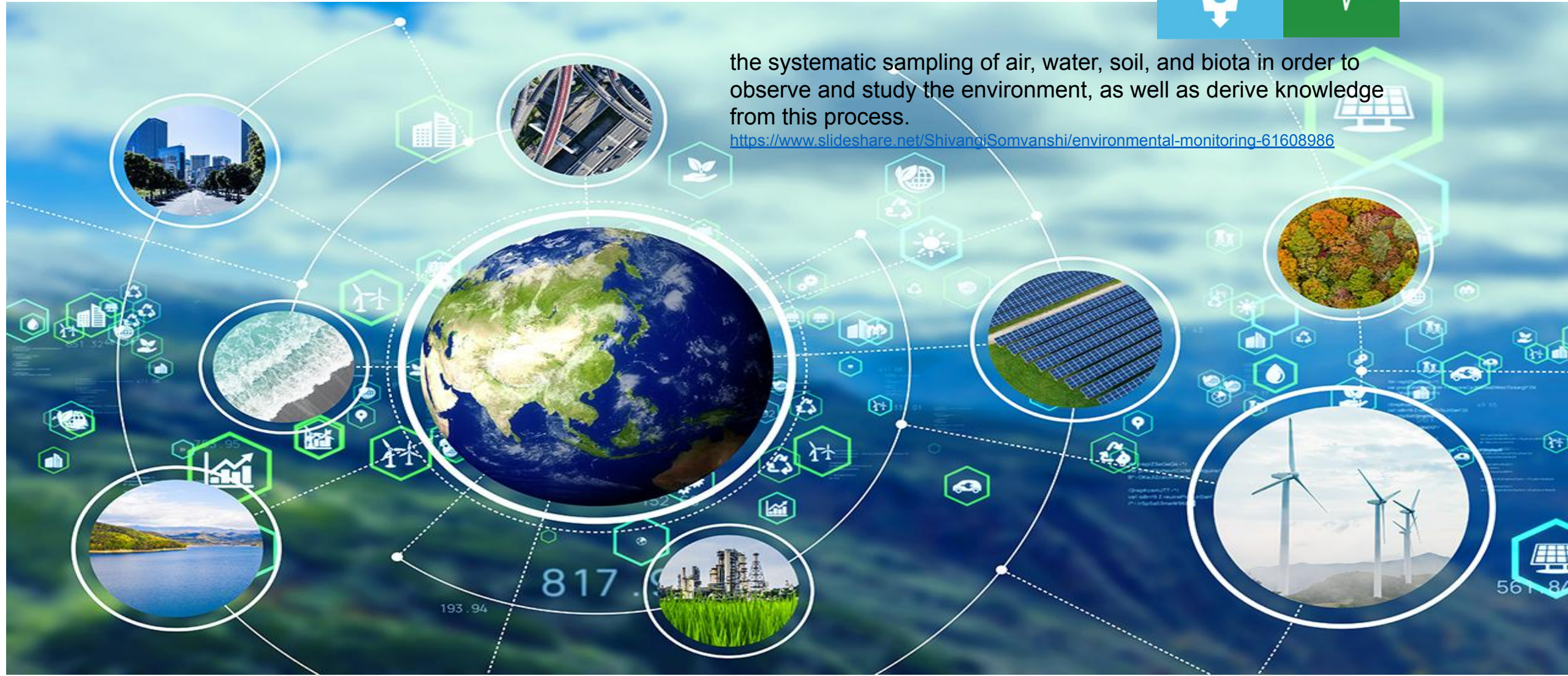

<https://www.digi.com/blog/post/what-is-environmental-monitoring>

Environmental monitoring

St-Dominique, Montreal Air Pollution: Real-time Air Quality Index (AQI)

ST-DOMINIQUE, MONTREAL

MOLSON, MONTREAL

MONTREAL

DRUMMOND, MONTREAL

ONTARIO, MONTREAL

JARDIN BOTANIQUE, MONTREAL



LOCATE THE NEAREST CITY



SEARCH FOR YOUR CITY

3 GOOD HEALTH AND WELL-BEING

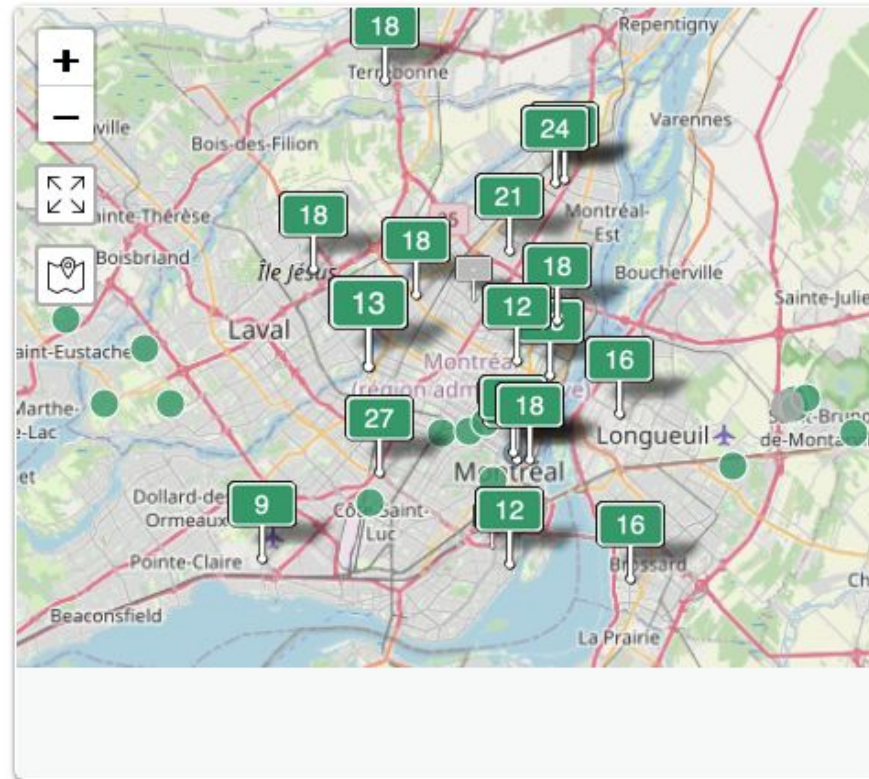
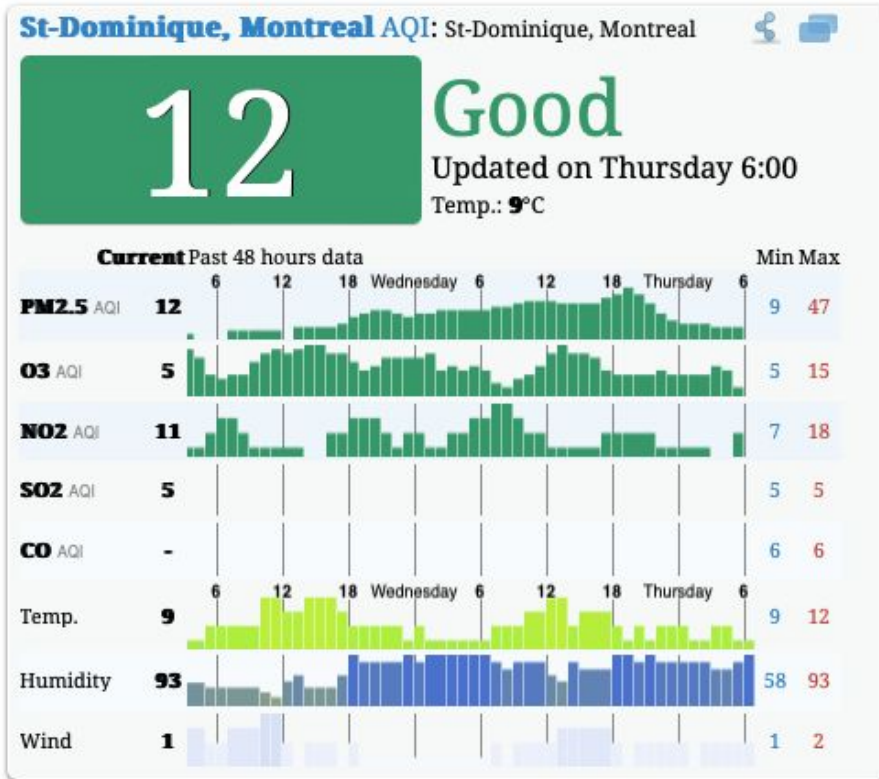

<http://aqicn.org/city/canada/montreal/st-dominique/>

Environmental monitoring

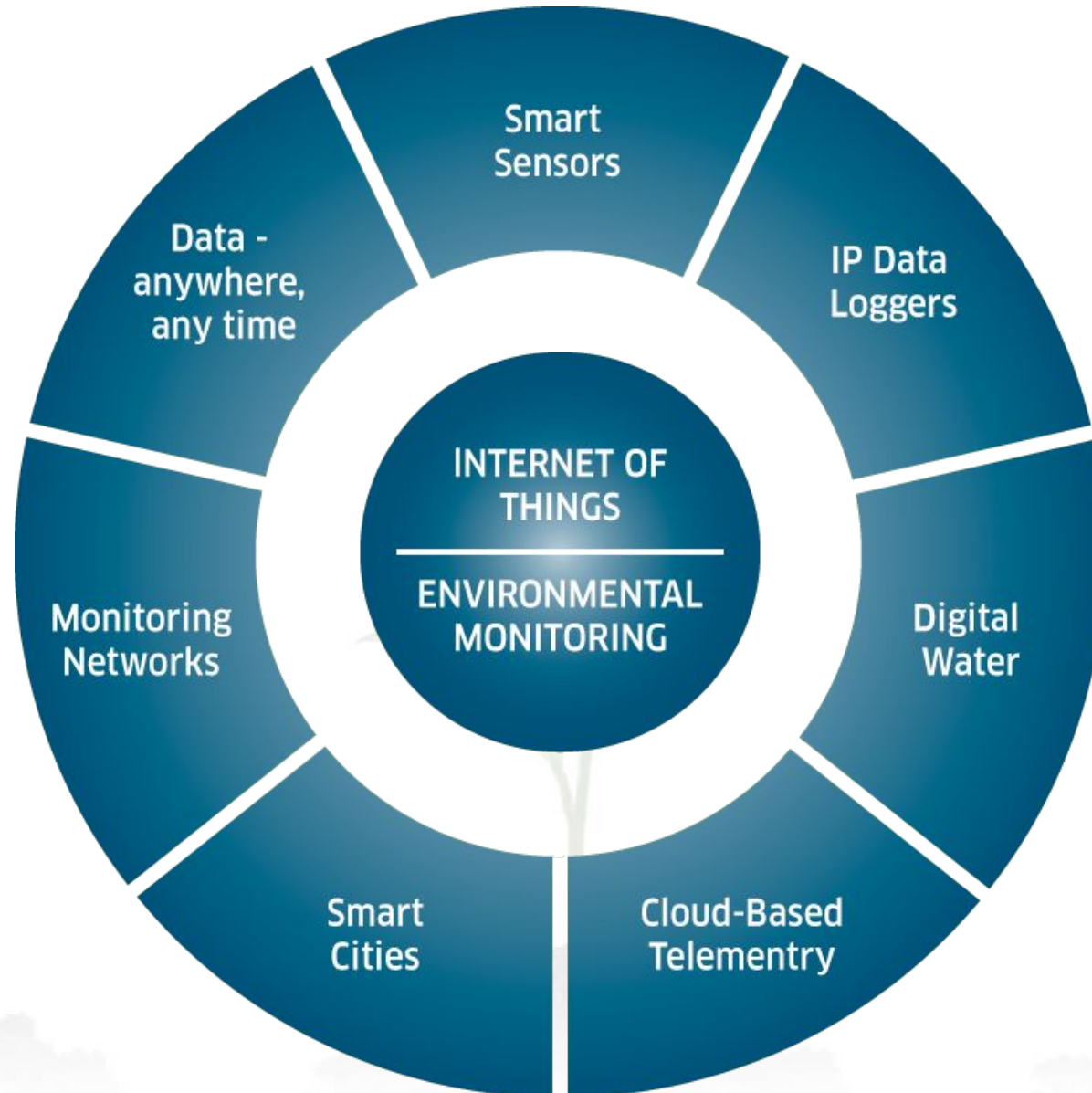

Elmustafa Sayed Ali Ahmed¹, Mujtaba Elbagir Yousef, Internet of things in Smart Environment: Concept, Applications, Challenges, and Future Directions, WSN 134(1) (2019) 1-51, <http://www.worldscientificnews.com/wp-content/uploads/2019/06/WSN-1341-2019-1-51-1-1.pdf>

Biosensors

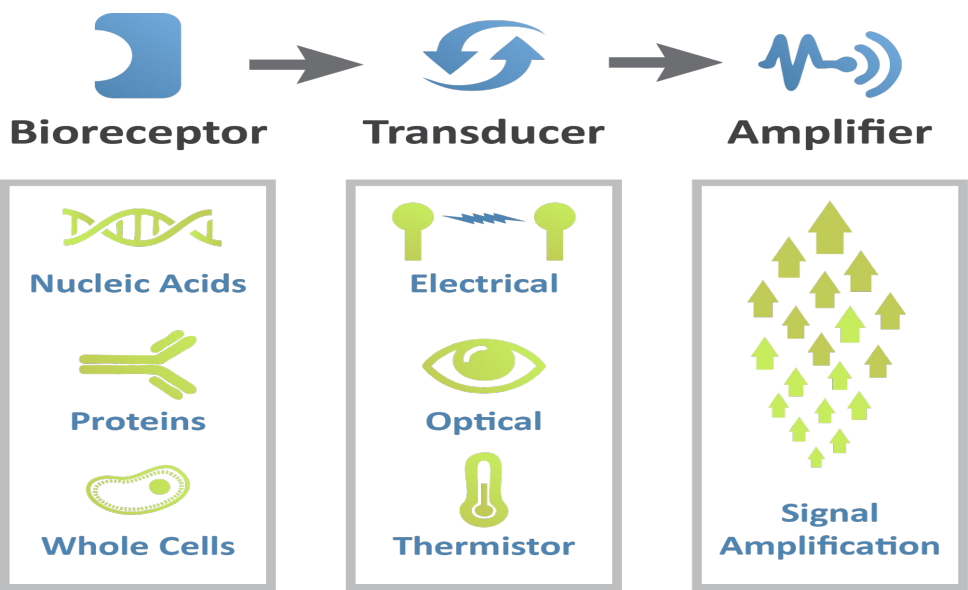

<https://www.innovogene.com/store/pc/viewcontent.asp?idpage=11>

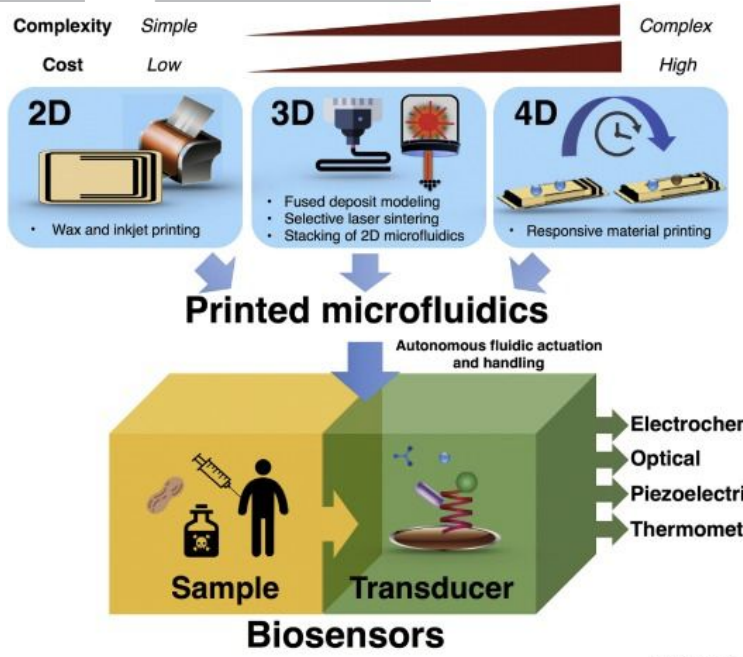

Jacky F.C. Loo, Aaron H.P. Ho, Anthony P.F. Turner, Wing Cheung Mak, Integrated Printed Microfluidic Biosensors, Trends in Biotechnology, Volume 37, Issue 10, 2019, Pages 1104-1120, ISSN 0167-7799,

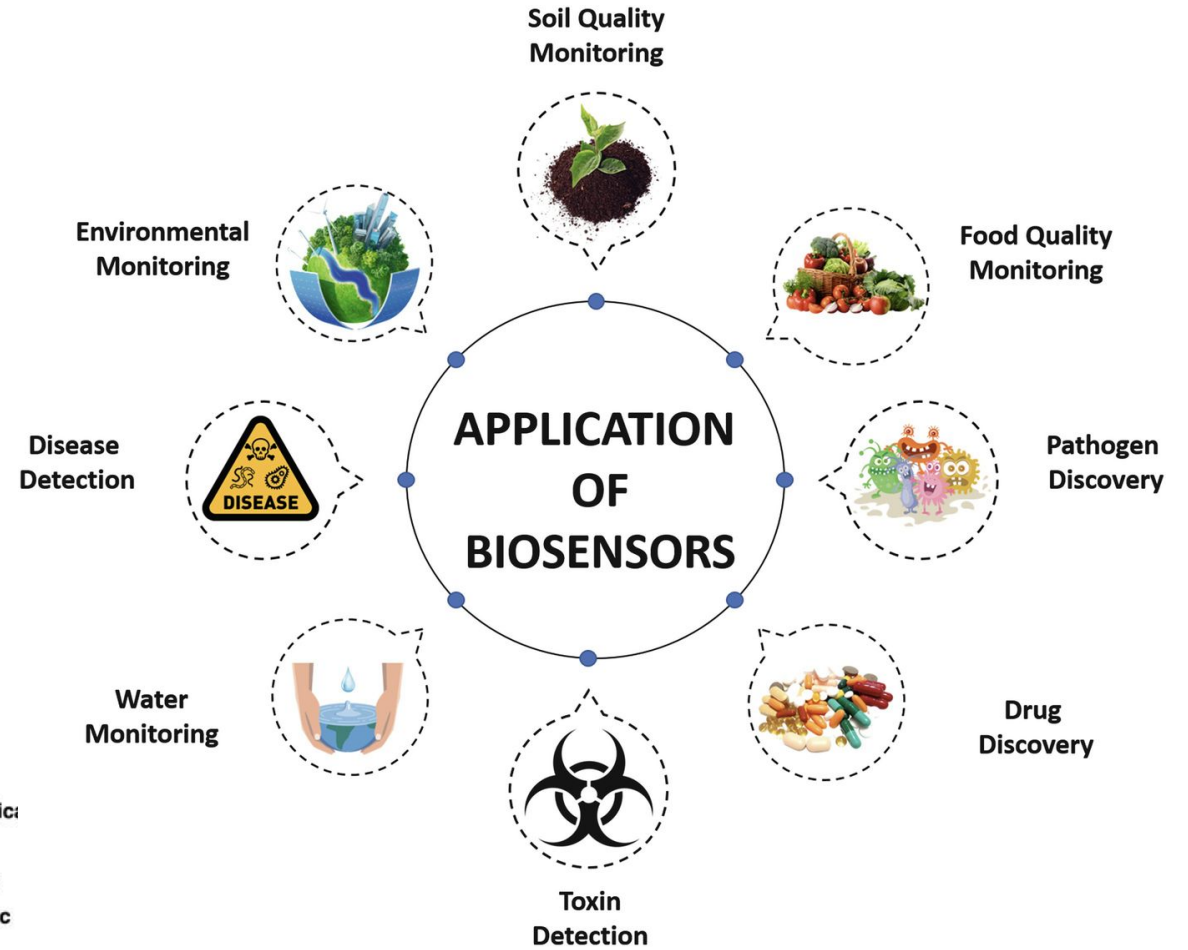

Singh S., Kumar V., Dhanjal D.S., Datta S., Prasad R., Singh J. (2020) Biological Biosensors for Monitoring and Diagnosis. In: Singh J., Vyas A., Wang S., Prasad R. (eds) Microbial Biotechnology: Basic Research and Applications. Environmental and Microbial Biotechnology. Springer, Singapore. https://doi.org/10.1007/978-981-15-2817-0_14

Wastewater-based epidemiology

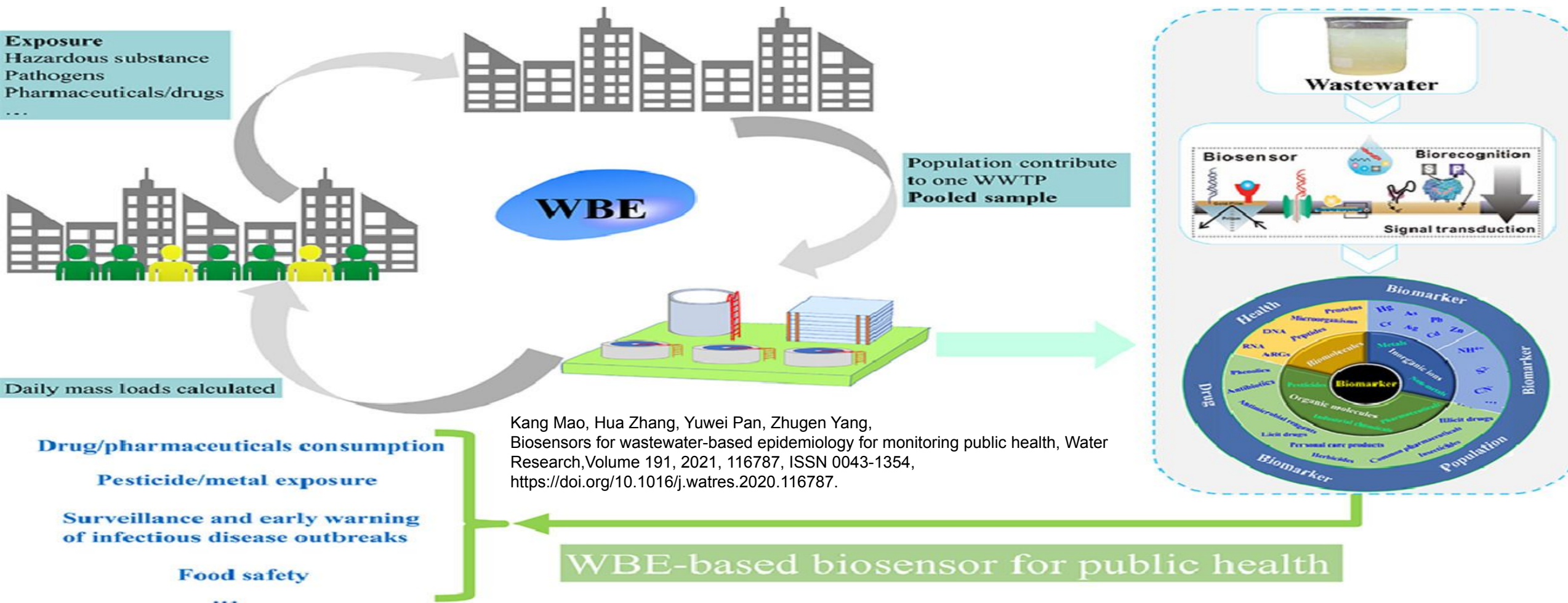

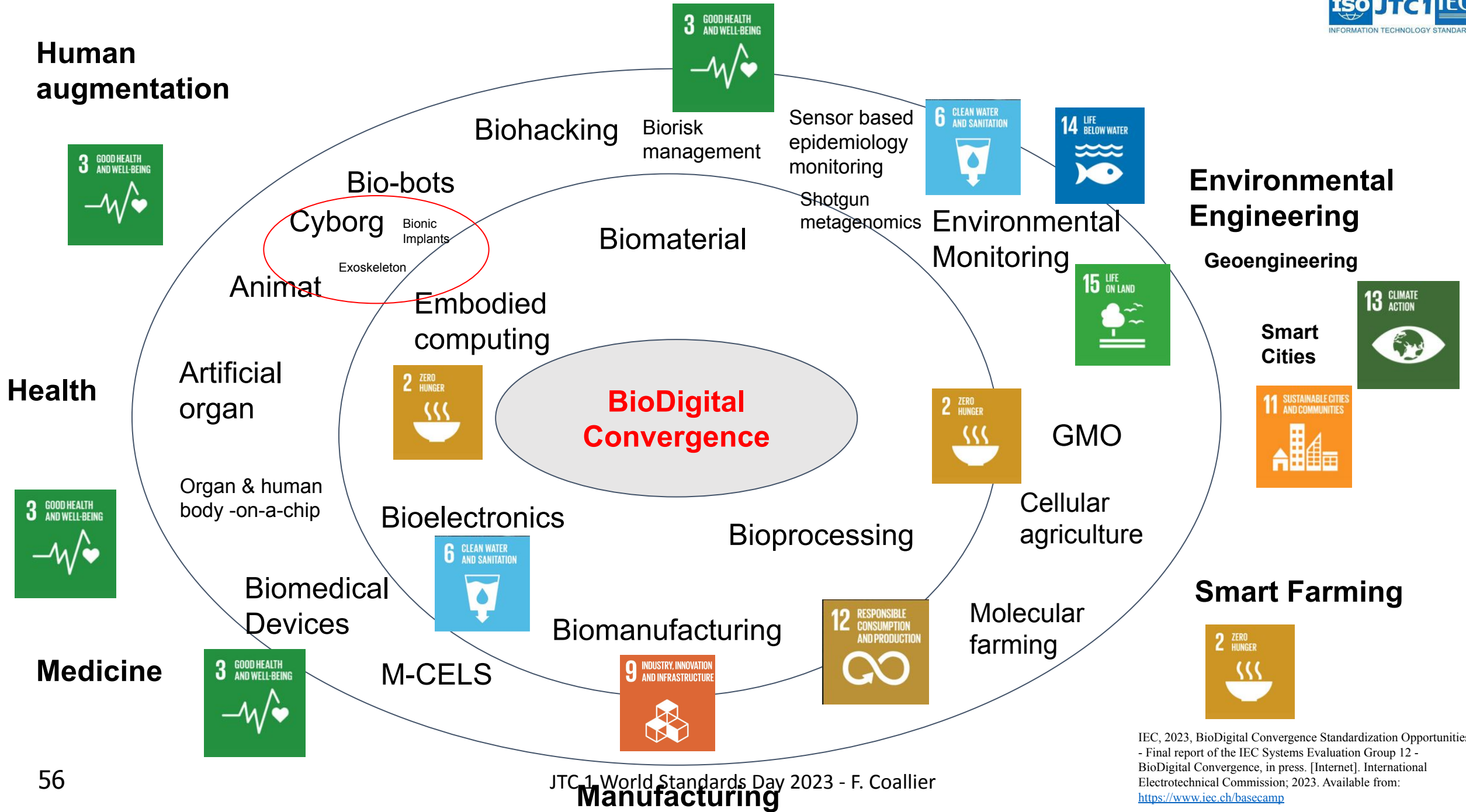

IEC, 2023, BioDigital Convergence Standardization Opportunities - Final report of the IEC Systems Evaluation Group 12 - BioDigital Convergence, in press. [Internet]. International Electrotechnical Commission; 2023. Available from: <https://www.iec.ch/basecamp>

Human Augmentation Technologies

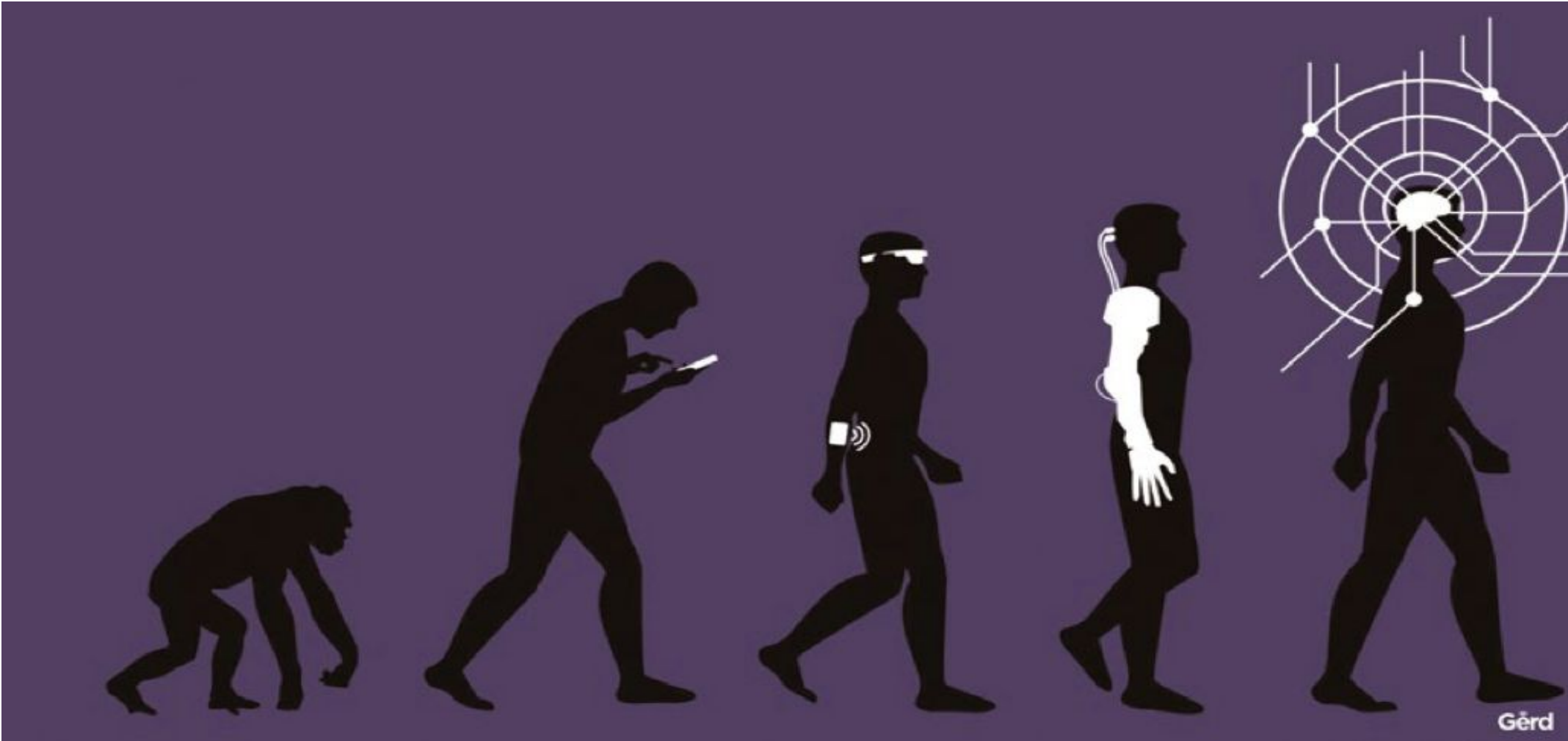

Modified from: Human Augmentation - The Dawn of a New Paradigm, A strategic implication project, UK Ministry of Defence (MOD), May 2021, https://assets.publishing.service.gov.uk/government/uploads/system/uploads/attachment_data/file/986301/Human_Augmentation_SIP_access2.pdf



Human Augmentation Technologies

Phase 1. Recovering, repairing the existing impaired human physiological functions. Most assistive technologies in this phase, e.g., rehabilitation exoskeleton, focuses on rehabilitation scenarios in hospitals and at home.

Phase 2. Replicating, substituting human functions and organs. Power augmentation Exoskeletons (rehabilitation exoskeleton excluded) and artificial organs are common examples at Phase 2. External devices that supplement the daily life living, e.g., smart watches and VR glasses, are also considered as typical use cases.

Phase 3. Enhancing, outperforming human capabilities. Applications aiming at exceeding human abilities are performed using emerging technologies from biomechanical engineering to genetic engineering

Source: Preliminary findings of IEC SEG 12/WG4

Global Human Augmentation Market- By Region (2019-2027)

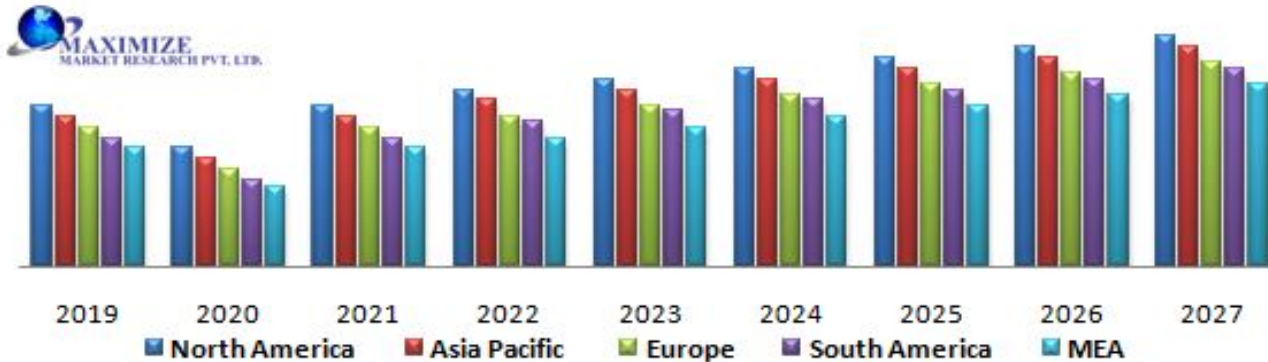

<https://www.maximizemarketresearch.com/market-report/global-human-augmentation-market/66366/>

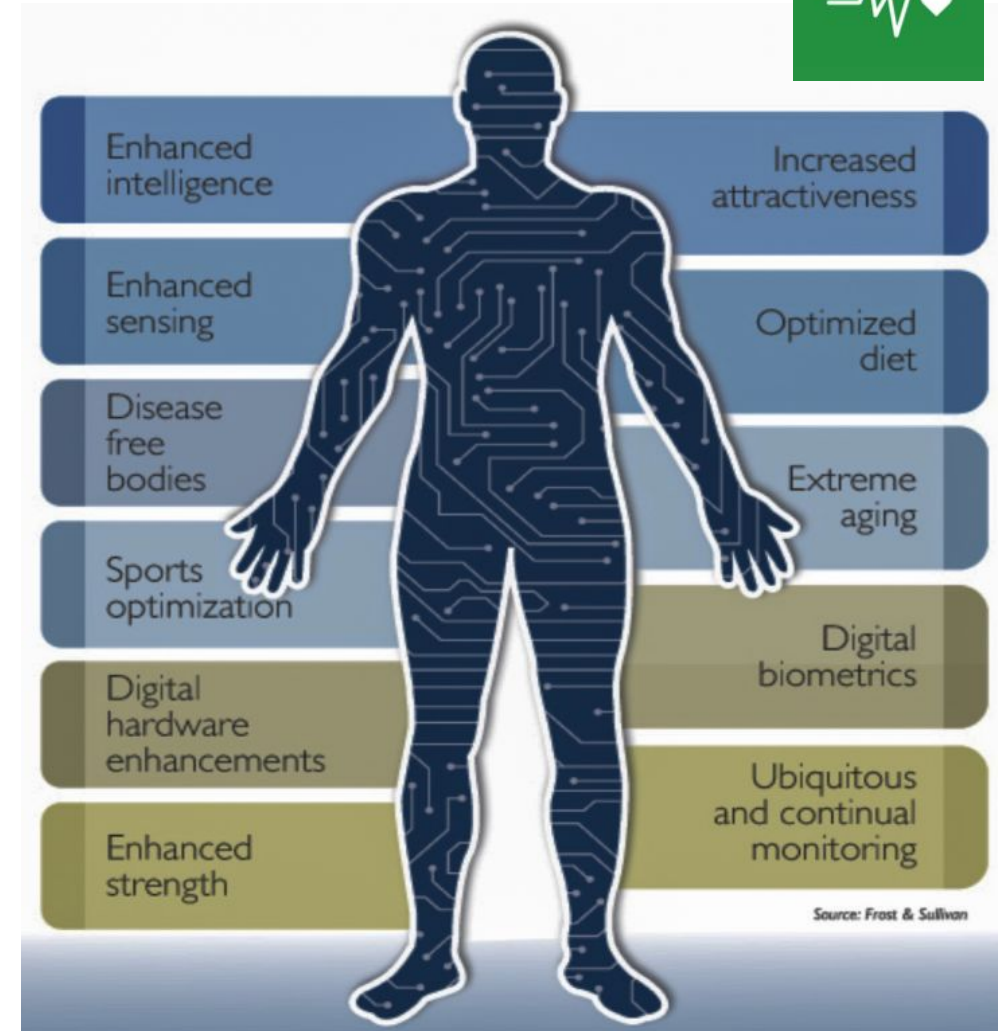

Source: Frost & Sullivan

<https://cmte.ieee.org/futuredirections/2018/08/09/transhumanism-evolving-the-human-body-ii/>

Cyber Physical Systems

Cyber-Physical Systems (CPS) comprise interacting digital, analog, physical, and human components engineered for function through integrated physics and logic. These systems will provide the foundation of our critical infrastructure, form the basis of emerging and future smart services, and improve our quality of life in many areas.

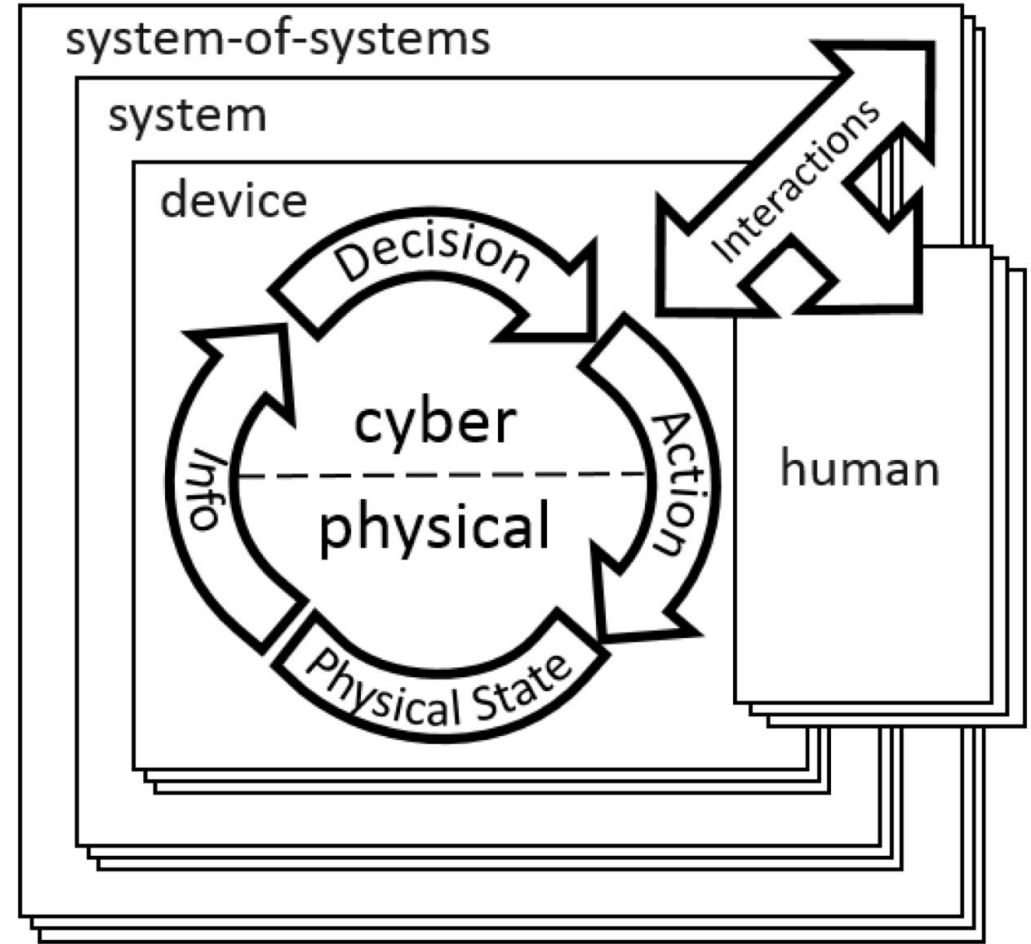

Figure 1: CPS Conceptual Model

<https://www.nist.gov/el/cyber-physical-systems>

<https://www.nist.gov/el/cyber-physical-systems>



<https://iot.eetimes.com/a-new-robotic-exoskeleton-could-help-thousands-walk-again/>

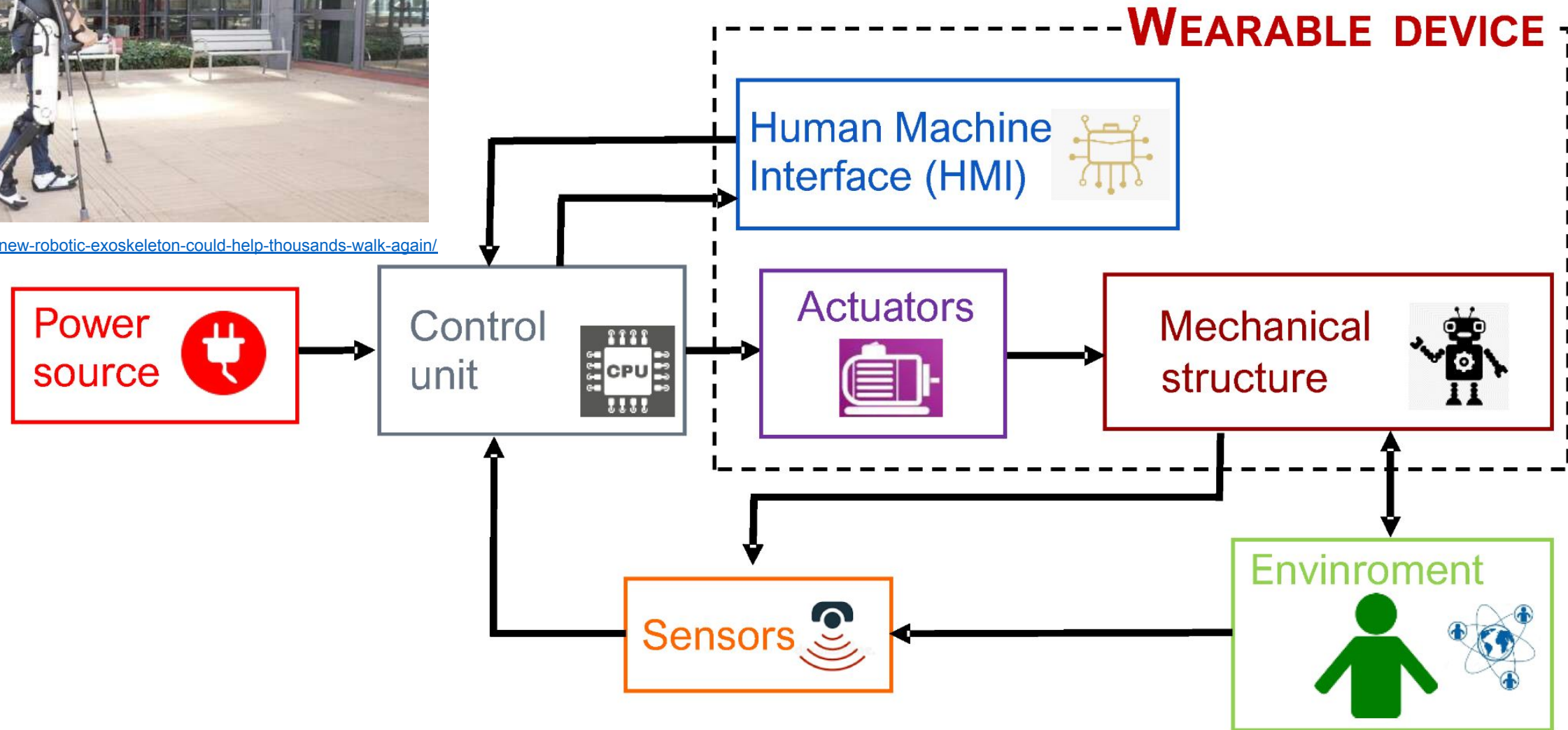

Tiboni, Monica, Alberto Borboni, Fabien V rit , Chiara Bregoli, and Cinzia Amici. 2022. "Sensors and Actuation Technologies in Exoskeletons: A Review" *Sensors* 22, no. 3: 884. <https://doi.org/10.3390/s22030884>
<https://www.mdpi.com/1424-8220/22/3/884>

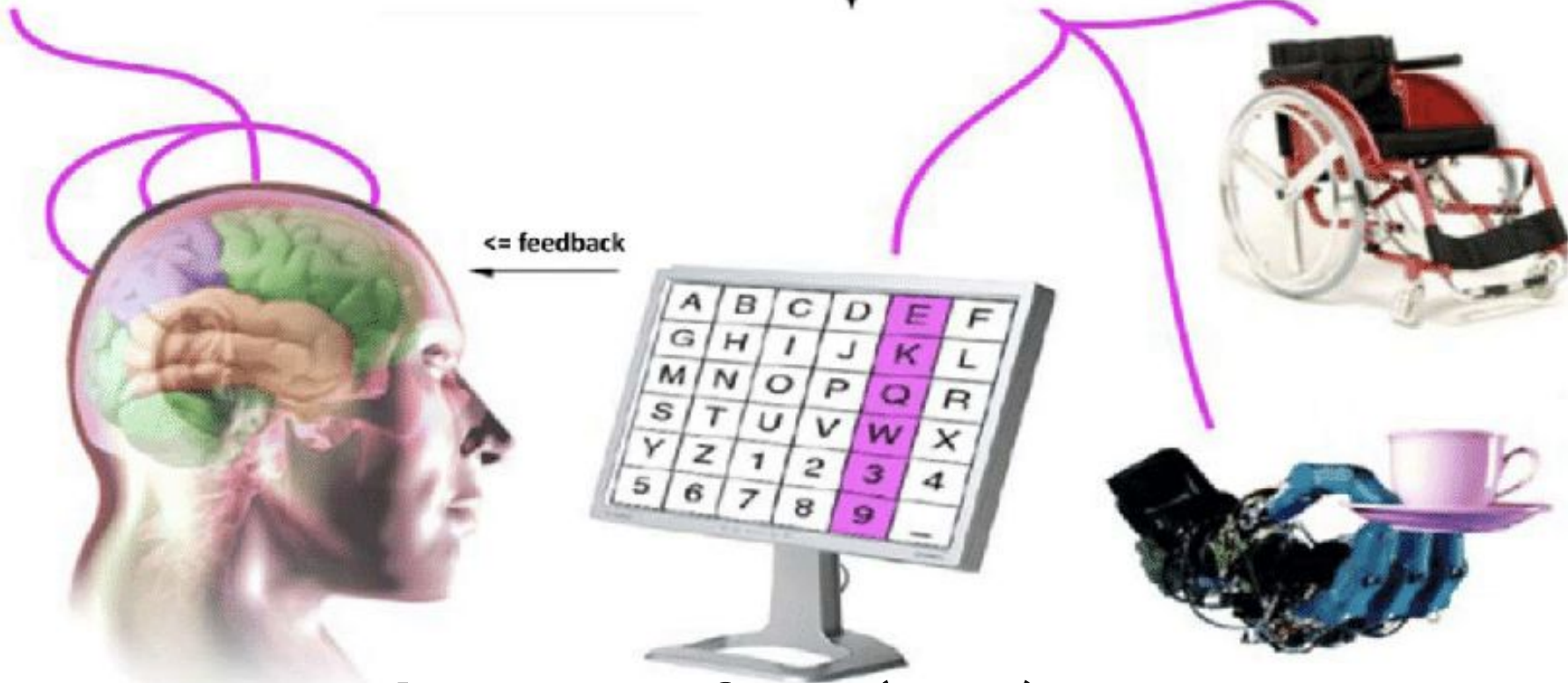
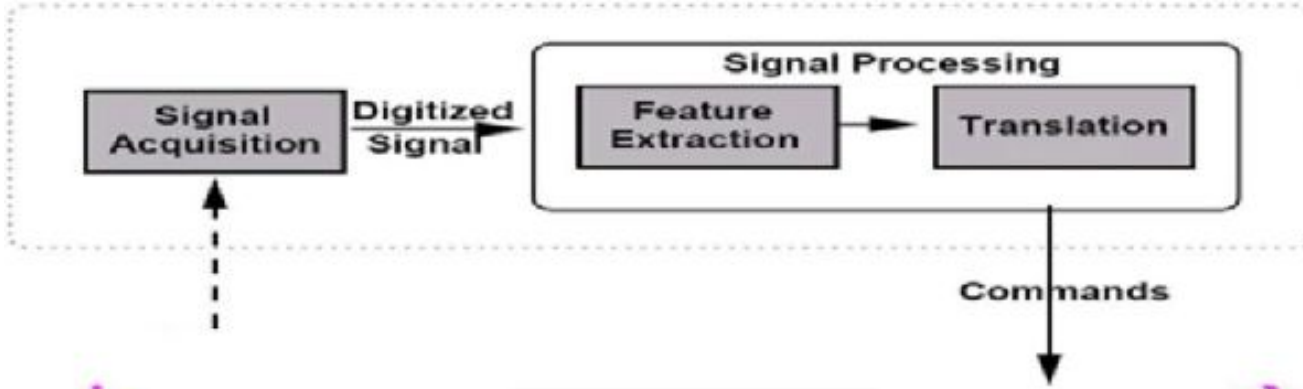

Brain Machine Interface (BMI) concept

Lachezar Bozhkov, Petia Georgieva,









https://www.researchgate.net/publication/335645290_Deep_Learning_in_Brain_Computer_Interfaces

JTC 1 World Standards Day 2023 - F. Coallier

CONCLUSION

Digital Twins



Category	Personal	Hospital	Community
Visualisation	 <p>Holographic Projections of Human Systems</p>	 <p>3D Model of Hospital</p>	 <p>Map showing Covid-19 Clusters</p>
Analysis and modelling	 <p>Predictive Analytics Tools based on AI</p>	 <p>Hospital Command Centre</p>	 <p>Community Healthcare Planning Insights</p>
Sensors	 <p>Personal Wearable Devices</p>	 <p>Real-Time Location Sensors</p>	 <p>Sensors in the Community</p>

<https://www.hinz.org.nz/news/575743/Digital-twins-in-future-healthcare.htm>



Thank You!

Annexes

ISO/IEC JTC 1/SC 41

Technical Areas	ISO/IEC JTC 1 (Information Technology) Subcommittees and Working Groups
Application Technologies	SC 36 - Learning Technology
Cultural and Linguistic Adaptability and User Interfaces	SC 02 - Coded Character Sets SC 22/WG 20 – Internationalization SC 35 - User Interfaces
Data Capture and Identification Systems	SC 17 - Cards and Personal Identification SC 31 - Automatic Identification and Data Capture Techniques
Data Management Services	SC 32 - Data Management and Interchange
Document Description Languages	SC 34 - Document Description and Processing Languages
Information Interchange Media	SC 23 - Optical Disk Cartridges for Information Interchange
Multimedia and Synthesis	SC 24 - Computer Graphics and Image Processing SC 29 - Coding of Audio, Picture, and Multimedia and Hypermedia Information WG12 - 3D Scanning and Printing
Networking and Middleware	SC 06 - Telecommunications and Information Exchange Between Systems SC 25 - Interconnection of Information Technology Equipment SC 38 - Cloud Computing and Distributed Platforms
Office Equipment	SC 28 - Office Equipment
Green IT	SC 39 – Sustainability, IT and data centres
Programming Languages and Software Interfaces	SC 22 - Programming Languages, their Environments and Systems Software Interfaces
Cybersecurity	SC 27 - Information security, cybersecurity and privacy protection SC 37 - Biometrics
Software, Processes and Systems	SC 07 - Software and System Engineering SC 40 – IT Governance and IT Management WG13 - Trustworthiness
Internet of Things	SC 41 – Internet of Things and Digital Twin
Artificial Intelligence	SC 42 - Artificial Intelligence
Brain-computer interfaces	SC43 - Brain-computer interfaces
Smart Cities	WG 11 - Smart City
Quantum Computing	WG 14 - Quantum Computing

SC 41 Structure (June 16, 2023)

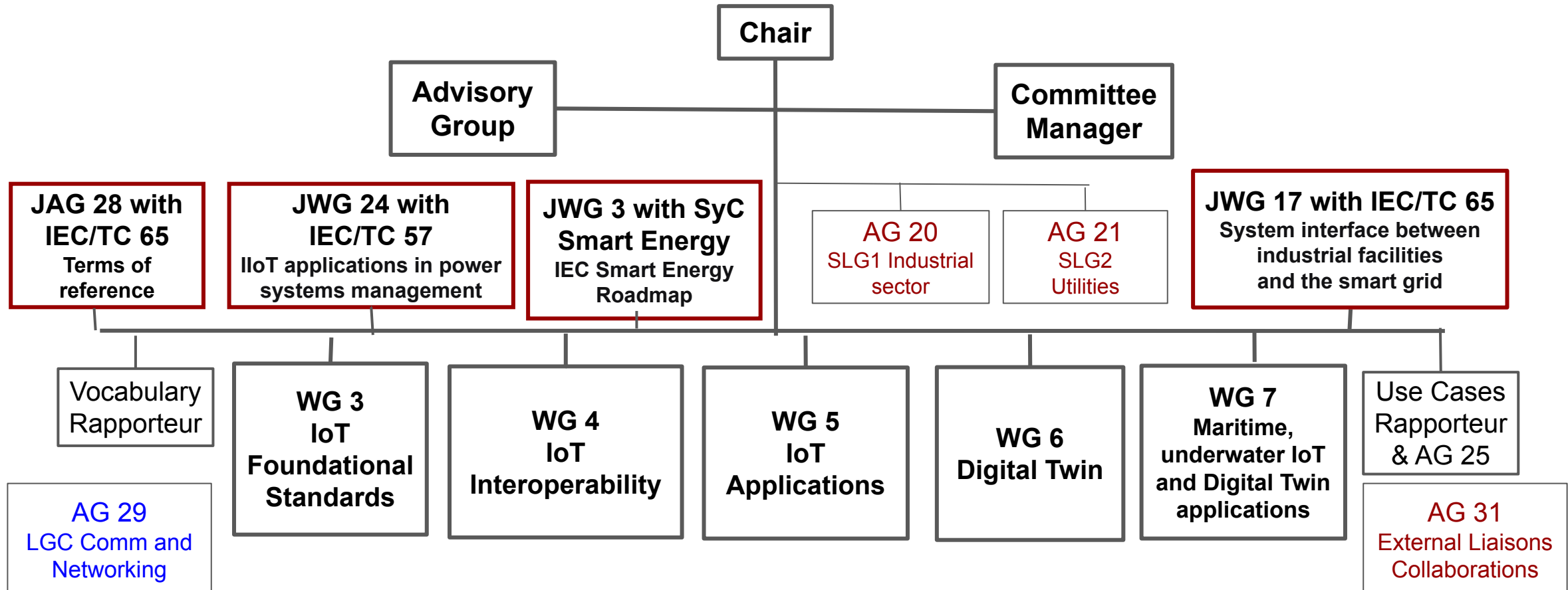

Published Standards

(TR technical report – TS technical specification)

<p>20924 2021 IoT - Vocabulary</p>	<p>21823-1 2020 IoT interoperability - framework</p>	<p>22417 TR 2017 IoT use cases</p>	<p>29182-1 2017 SNRA General overview and requirements</p>	<p>29182-7 2015 SNRA Interoperability guidelines</p>	<p>30140-1 2018 UWASN – Overview and requirements</p>
<p>30141 2018 IoT reference architectures</p>	<p>21823-2 2020 IoT transport interoperability</p>	<p>30163 2021 SN-based integrated platform for chattel asset monitoring</p>	<p>29182-2 2013 SNRA Vocabulary and terminology</p>	<p>20005 2013 Collaborative information processing in intelligent SN</p>	<p>30140-2 2017 UWASN – Reference architecture</p>
<p>30147 2021 Integration of IoT trustworthiness in ISO/IEC/IEEE 15288</p>	<p>21823-3 2021 IoT semantic interoperability</p>	<p>30169 2022 IoT applications for electronic label systems (ELS)</p>	<p>29182-3 2014 SNRA Reference architecture views</p>	<p>30128 2014 Generic SN Application Interface</p>	<p>30140-3 2018 UWASN – Entities and interfaces</p>
<p>30164 2020 IoT Edge computing</p>	<p>21823-4 2024 IoT syntactic interoperability</p>	<p>30176 TR 2021 Integration of IoT and DLT/blockchain: use cases</p>	<p>29182-4 2013 SNRA Entity models</p>	<p>19637 2016 SN testing framework</p>	<p>30140-4 2018 UWASN – Interoperability</p>
<p>30165 2021 Real-time IoT</p>	<p>30161-1 2020 Data exchange platform for IoT - Requirements & architecture</p>	<p>30179 2023 IoT system for ecological environment monitoring</p>	<p>29182-5 2013 SNRA Interface definitions</p>	<p>22560 TR 2017 SN - Aeronautics active air-flow control</p>	<p>30142 2020 UWASN – Network mgt system overview & requirements</p>
<p>30166 TR 2020 Industrial IoT</p>	<p>30161-2 2023 Data exchange platform for IoT – Transport interoperability</p>		<p>29182-6 2014 SNRA Applications</p>	<p>30101:2014 SN and its interfaces for smart grid system</p>	<p>30142-2 2020 UWASN – Network management system u-MIB</p>
	<p>30162 2023 Compatibility requirements within industrial IoT systems</p>				<p>30143 2020 UWASN – Application profiles</p>
					<p>30171-1 2022 B-UWAN -Overview and requirements</p>
Foundational	Interoperability	Application	Sensor network		Underwater acoustic network

SC41 Standards under development

20924 Ed2 IoT and digital twin – Vocabulary (WG3)	30173 Digital twin concepts and terminology (WG6)
30141 Ed2 IoT reference architecture (WG3)	30168 TS Generic Trust Anchor API for Industrial IoT Devices (WG3)
30149 TS IoT trustworthiness principles (WG3)	30187 Evaluation indicator for IoT systems (WG5)
30188 Digital twin Reference Architecture (WG6)	PWI 16 Digital Twin – Extraction and transactions of data components (WG6)
30186 Digital twin maturity model (WG6)	PWI 17 Guidance on IoT and digital twin integrations in data spaces (WG6)
Foundational	

30178 IoT Data format, value and coding (WG4)
30181 Functional architecture for resource ID interoperability (WG4)
PWI 8 IoT and Digital twin Behavioral and policy interoperability (WG4)
TR PWI 11 Digital twin correspondence measure of DTw twinning (WG6)
Interoperability

30194 TR Best practices for use case projects (SC41)	30172 TR Digital twin use cases (WG5)
30180 Status of self-quarantine through IoT data interfaces (WG5)	30184 Autonomous IoT object identification in connected home (WG5)
30189-1 TR IoT-based cultural heritage management – Framework (WG5)	
TR PWI 13 IoT Apps for long-distance oil & gas transmission pipeline (WG5)	TR PWI 12 Environmental effect of underwater acoustic signalling (WG7)
TR PWI IoT Apps for natural gas distribution system (WG5)	TR PWI 10 IoT-based cultural heritage management – Use cases (WG5)
PWI System requirements of IoT-based fixed asset seizure management (WG5)	
Applications	

30177 Underwater network mgt system (U-NMS) interworking (WG7)
30183 Interoperability of UWASNs based on underwater delay & U-DTN (WG7)
30185 Interoperability of UWASNs & IPV6 (WG7)
Underwater

“The role of IT Standards in National strategy for Transformation (NST1) by achieving and contributing to the Sustainable development Goals (SDGs 3) of Good health and well being in developing countries”

Case: Rwanda

World Standards Day 2023

Rwanda Standards Board (RSB)

12th October 2023



Names: Clement Regis TUYISHIME

Post: *Telecommunication and ICT Standards Officer*

Contents

- General Introduction
- Rwanda
- RSB and TCs
- IT standards to health sector
- NST 1(7 Year Rwanda Government programme)
- Benefits and Challenges
- Conclusion
- Questions and Answers

Rwanda

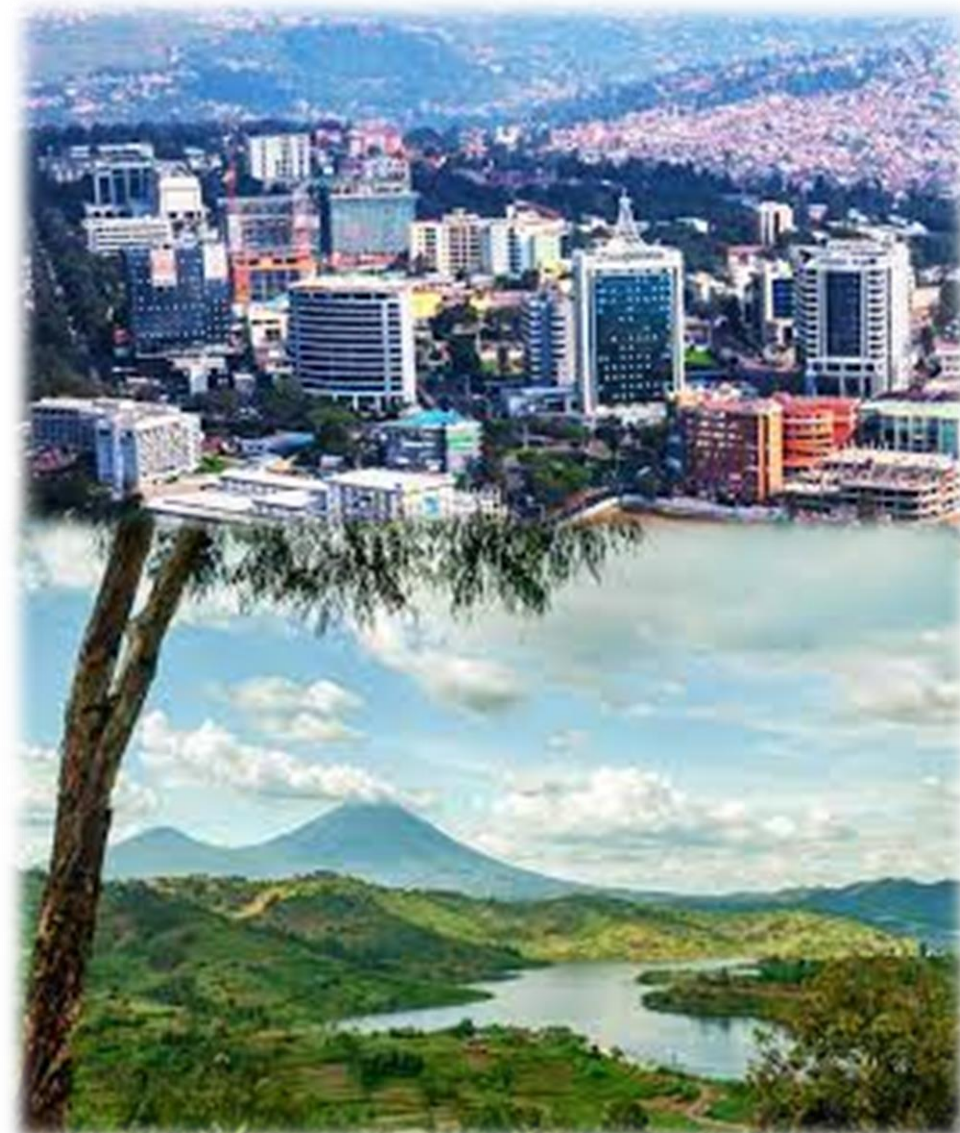

ABOUT RSB

VISION /MISSION

- To be a highly reputed party in providing internationally recognized customer-suited standardization, metrology and conformity assessment services.
- To provide quality and safety solutions through the provision of standardization, metrology, testing and certification services for sustainable socio-economic development.

Founded: 2002

Headquarter : Kigali

ORGANIZATION'S INVOLVEMENT

- Full member of ISO and
Affiliate member of IEC
- EAS and ARSO

Overview of RSB Services

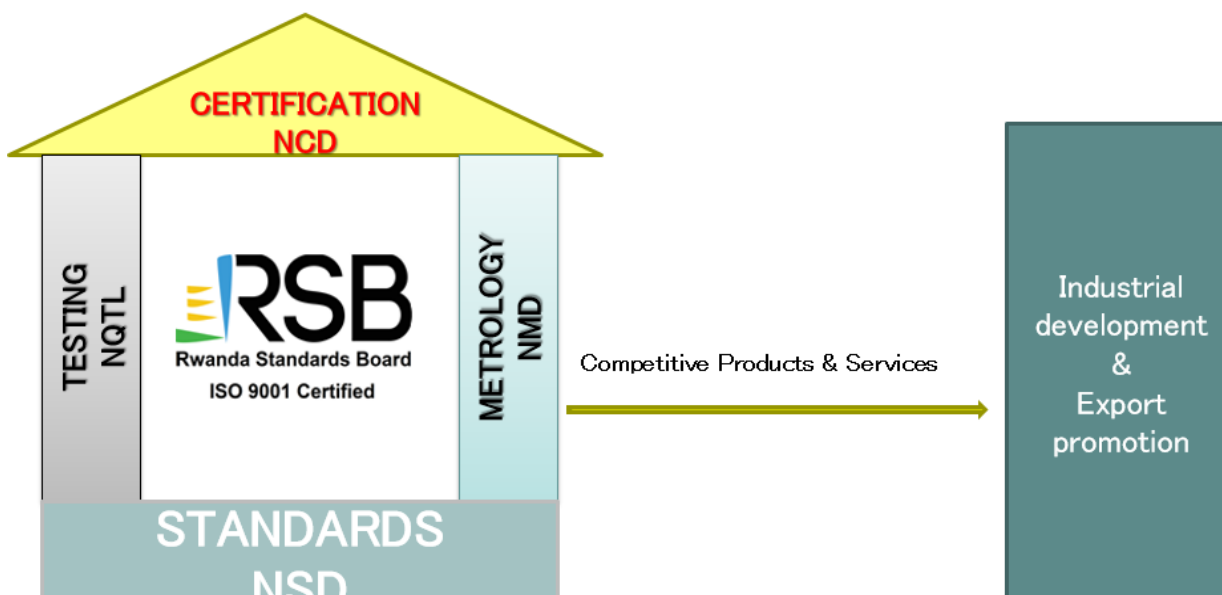

RSB HAS 4 TECHNICAL DIVISIONS:

- National Standards Division (NSD)
- National Quality Testing Laboratories(NQTL)
- National Metrology Services Division(NMD)
- National Certification Division (NCD)

Divisions Main Functions:

- Through NSD,RSB Develop and publish national standards (Disseminate information on standards Training stakeholders)
- Through NCD Offer product and system certification services
- Through NQTL Offer testing services
- Through NMD Provide metrology services

RSB/ TC 21: IT and Multimedia

- RSB TC 21(IT and Multimedia) is a Technical Committee (TC), developing the standards in the field of Information Communication Technology (ICT) and Multimedia.
- Standards of specifications, requirements, and test methods for IT infrastructure, software, multimedia, and their management as well as accessories.

Popular standards :

- RS ISO/IEC 27001:2022
- RS 507:2022
- RS ISO 10218

Standards by sectors(EUP)

Standards	Numbers
RS ISO	1838
RS IEC	398

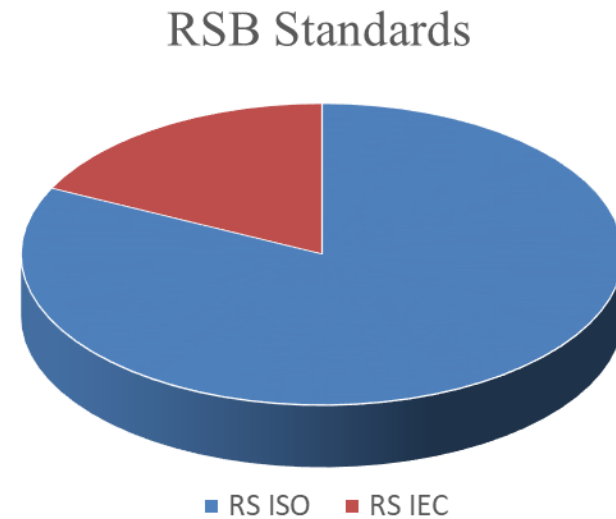

**The role of IT Standards in National strategy for Transformation (NST1)
by achieving and contributing to the Sustainable development Goals (SDGs) 3 of
Good health and well being in developing countries**

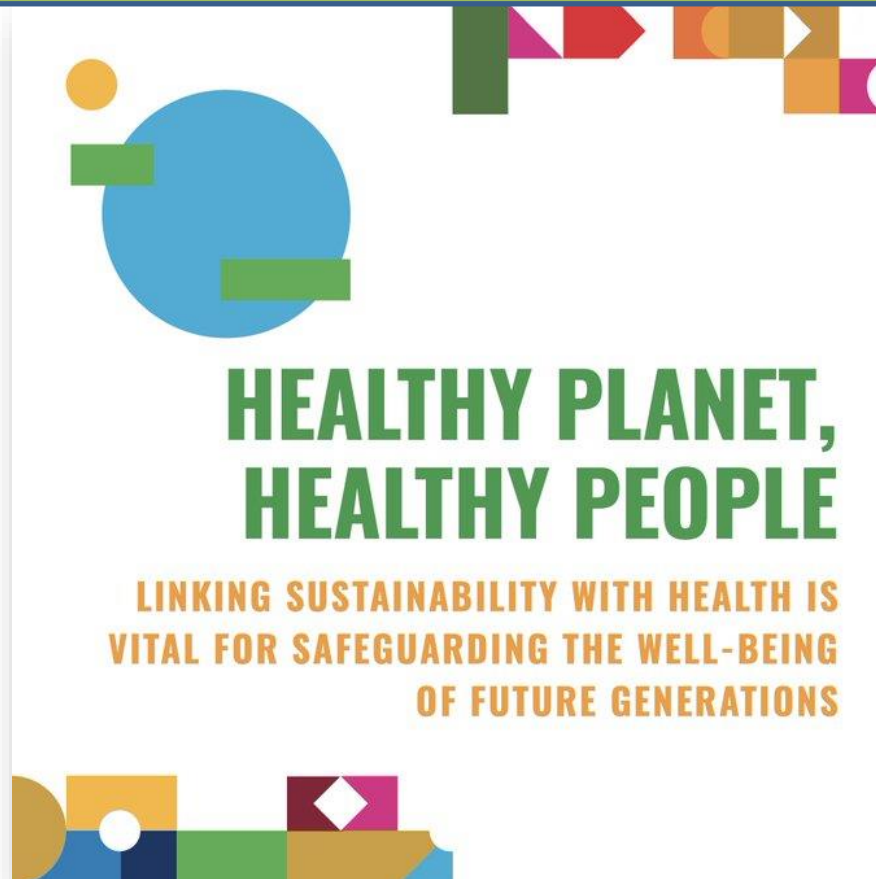

SDG3: Ensure healthy lives and promote well-being for all at all ages



THE SUSTAINABLE DEVELOPMENT GOALS REPORT 2023: SPECIAL EDITION- UNSTATS.UN.ORG/SDGS/REPORT/2023/

- by 2030, reduce the global maternal mortality ratio to less than 70 per 100,000 live births;
- by 2020, halve the number of global deaths and injuries from road traffic accidents;
- by 2030, substantially reduce the number of deaths and illnesses from hazardous chemicals and air, water and soil pollution and contamination.

Intersection of Health and ICT Sector

ICT contributes to health through:

- artificial Intelligence(AI);
- internet of Things (IoT);
- e-mobility;
- cloud computing;
- intelligent transportation;
- sensor networks, system and software engineering;
- IT governance;
- fiber optics;
- smart health;
- security, privacy, and Information management.

RSB Contribution

- RSB/TC 21 contributes to Sustainable Development Goals (SDGs) of the United Nations(UN) through developing the standards on national level.
- RSB/TC 21 Contributes to the SDG 3 “Good health and well-being”.

NST1 (National Strategy for transformation)

Vision 2025

- **High Quality and Standards of Life**
- Developing Modern Infrastructure and Livelihoods
- Transformation for Prosperity
- Values for Vision 2050
- International cooperation and positioning

NST1

- 7 Year Rwanda government programme

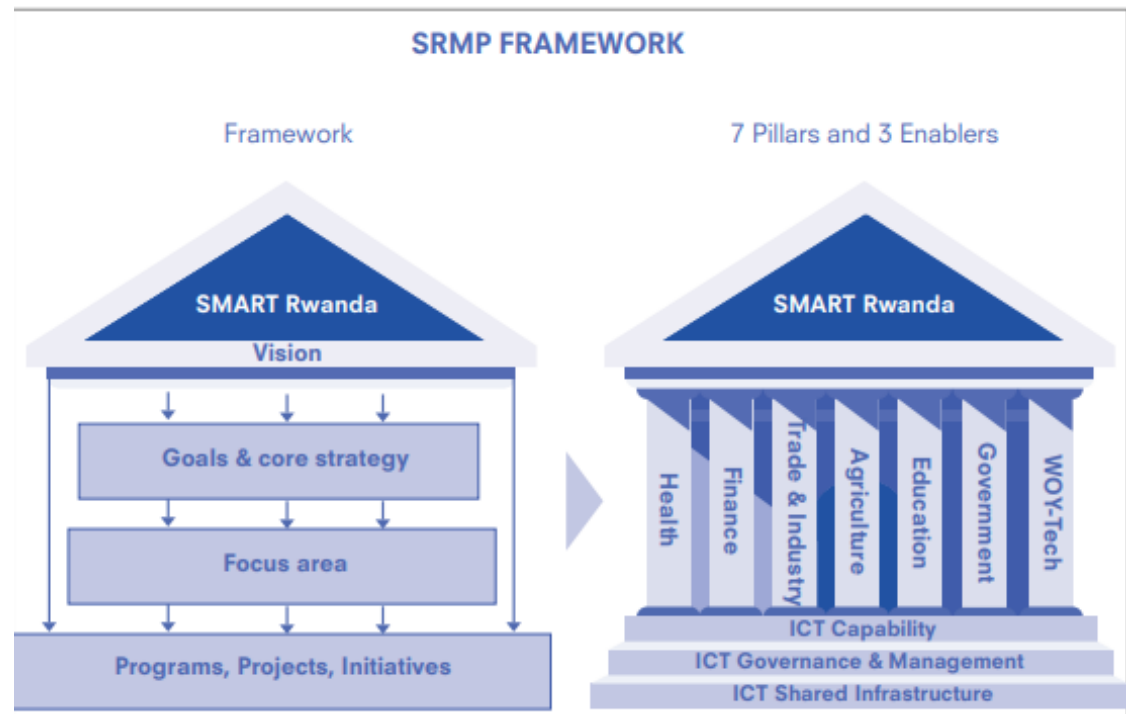

Standards contributing to SDGs3

Standard	Title
ISO/IEC 27000 family	Information technology — Security techniques — Information security management systems
RS 507: 2022	Electronic cane for people with visual impairment — Requirements
ISO 10218	Robots and robotic devices
ISO/TR 21718	intelligent transport systems
ISO/IEC 24773	Software and systems engineering
ISO/IEC 25000	Systems and software engineering

Benefits of IT standards to Health sector in Rwanda

- Capacity Development, HIV/AIDS and Non-Communicable Diseases,
- Disability and Social Inclusion,
- Environment and Climate Change,
- Regional Integration and International Positioning,
- Priority Area 3: Enhancing demographic dividend through ensuring access to quality health for all,
- Accelerated industrialization for economic transformation,
- Increased usage of electronic payment systems,
- Reduced maternal mortality,
- Enhanced access to basic infrastructure for health facilities,
- Sustainable Development through Smart Cities,
- Expanding telemedicine and consultation systems,
- Enhancing consumer healthcare systems

Contribution of ICT standards to Health sector based on NST1 in Rwanda

Expand medical and health services to enhance citizen's quality of life.

- Standards provide better social security and higher quality of lives through enhancement of information sharing between government institutions,
- Standards increase access to medical information and service and provide digitalized network for health information (e-Health),
- Standards provide technology information for an integrated health information system
- Standards offer a digitalized insurance claim system to systematically manage information for preemptive and efficient response measures.



Core activities

Contribution of ICT standards to Health sector based on NST1 in Rwanda

Expand medical and health services to enhance citizen's quality of life.

- Standards ensure universal access to affordable preventive, curative, and rehabilitative health services of the highest attainable quality,
- Standards empowering and transforming communities through improved access to health information and services,
- Standards have an effective structure, applications of information systems for supporting effective and efficient delivery of healthcare services.



Major direction of change and benefit

Challenges in implementation of the IT standards to Health sector

- Limited budget allocated to ICT and health sector,
- Limited skilled human resources to use the standards,
- Cost of standards implementation,
- Inadequate mechanisms used in health sector,
- Gap of the awareness about ICT standards to health sector.

Conclusion

- Rwanda through RSB has steadily made progress towards achieving the vision set for achieving a sustainable development Goal of **Good health and well being**.
- Notable in this effort Rwanda has been a strong and sustained emphasis on developing the standards in information and communication technology (ICT). Starting from dire conditions, the country has put ICT at the core of a reform agenda geared towards reconstruction and higher levels of development.
- However, Rwanda's ICT challenges mainly concern structural and cultural change. For instance, awareness for the benefits of ICT standards is still not widespread, a labor force highly skilled in ICT is still not a reality.

REFERENCES

Source	Title of Document	Published Date
7 Year Program	Government Programme (2010 -2017)	Oct., 2010
ITU (International Society Telecommunication Union)	Measuring the Information	2014
WTO (World Trade Organization)	World Health Statistics	2013
ISO (International Organization for Standardization)	Standards	

Thank You





*Providing accredited Quality Testing,
Certification and Metrology Services.*

VISIT OUR ONLINE SERVICES:

<https://portal.rsb.gov.rw>

 @rwandastandards  Rwanda Standards Board

 www.rsb.gov.rw  info@rsb.gov.rw

 0788303492 / 3250 (Toll-Free)

+250 788623006

regis.tuyishime@rsb.gov.rw

Standards for a better world



For more about ISO's work programme as it affects consumers, see the ISO Directory for consumer interest participation: www.iso.org/COPOLCO_interest

* In collaboration with IEC.



THE GLOBAL GOALS

For Sustainable Development

Data and AI for Healthcare

Ian Oppermann
October 2023

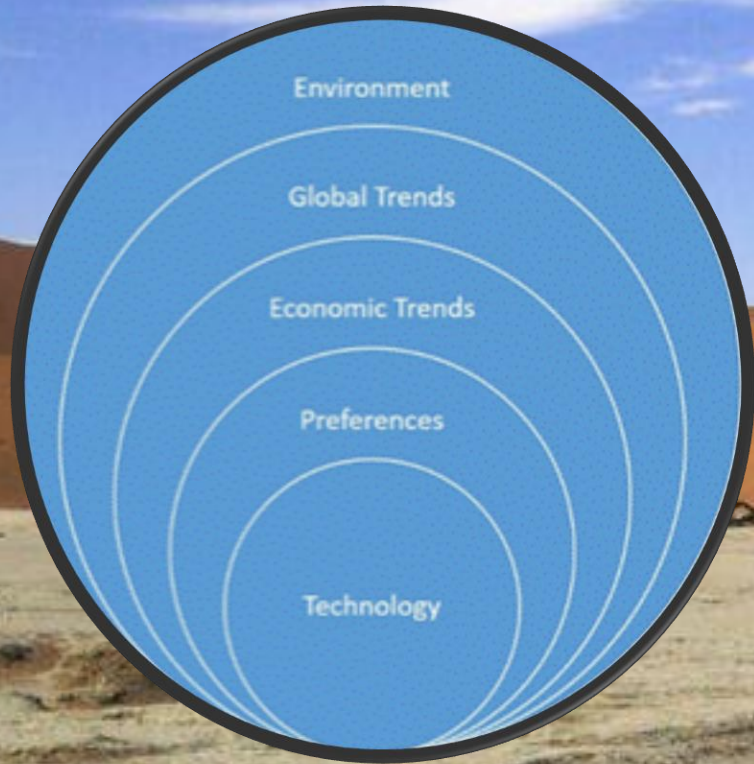

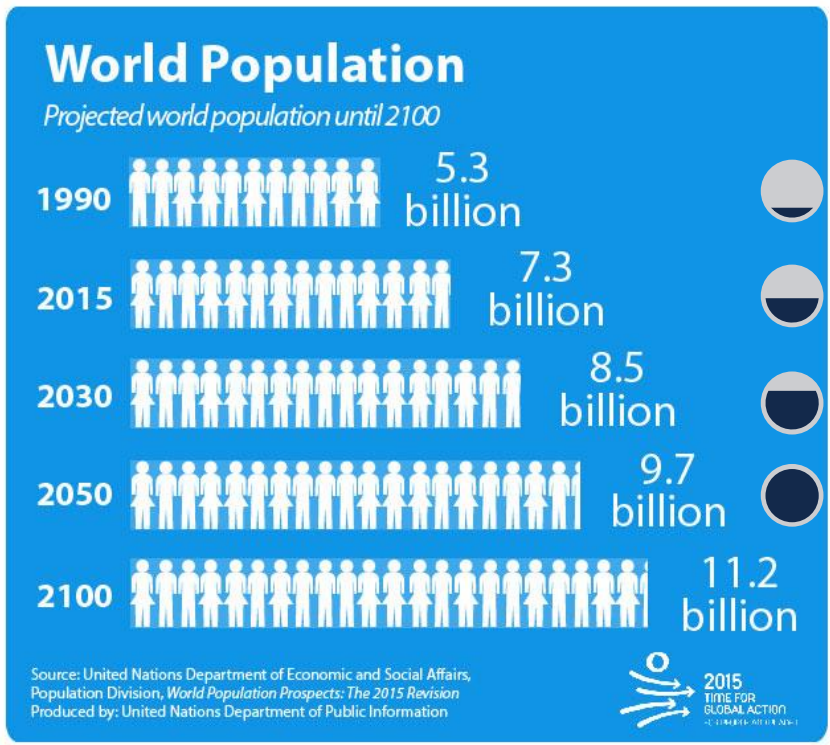
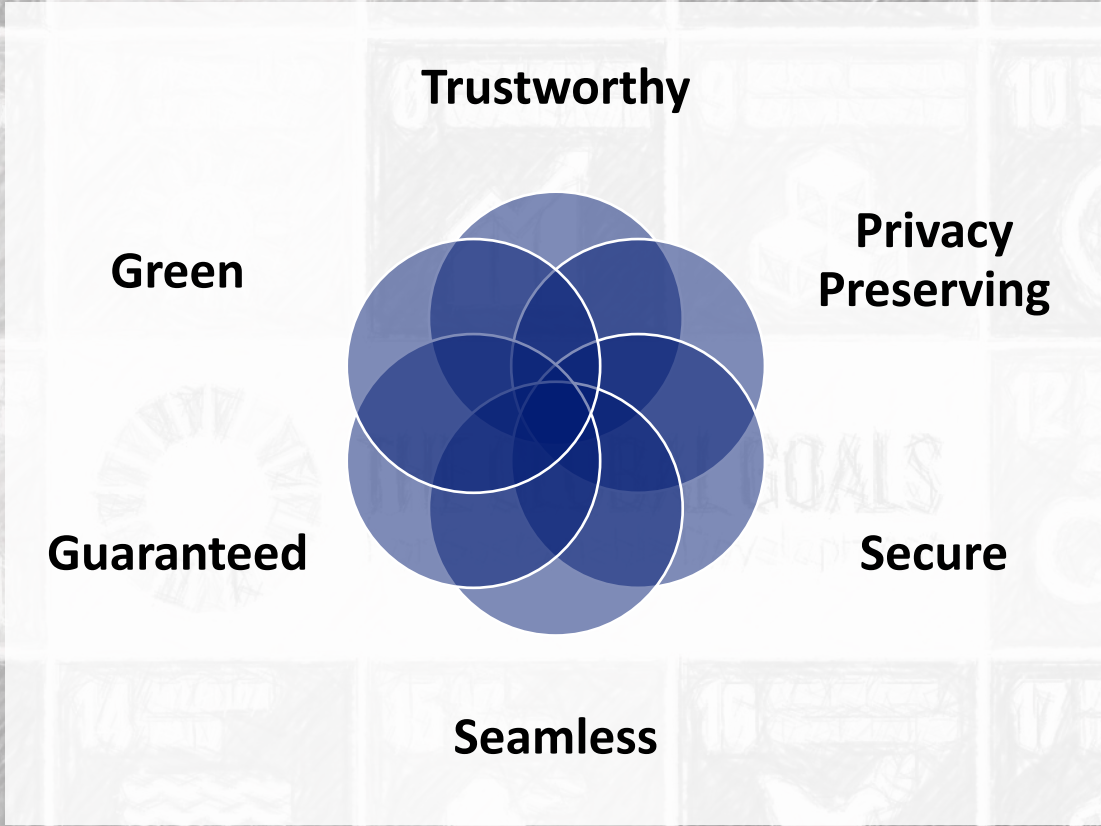

- GSM
- 3G
- 4G
- 5G
- 6G
- 7G
- 8G



Digitise (and Link)

Some Historical Examples

THE GLOBAL
of Sustainable Dev

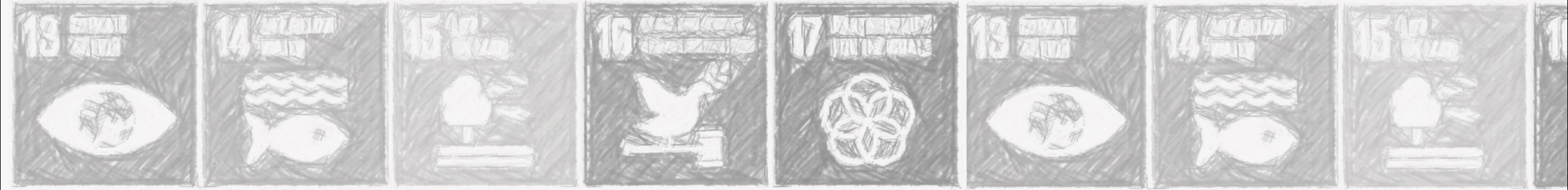

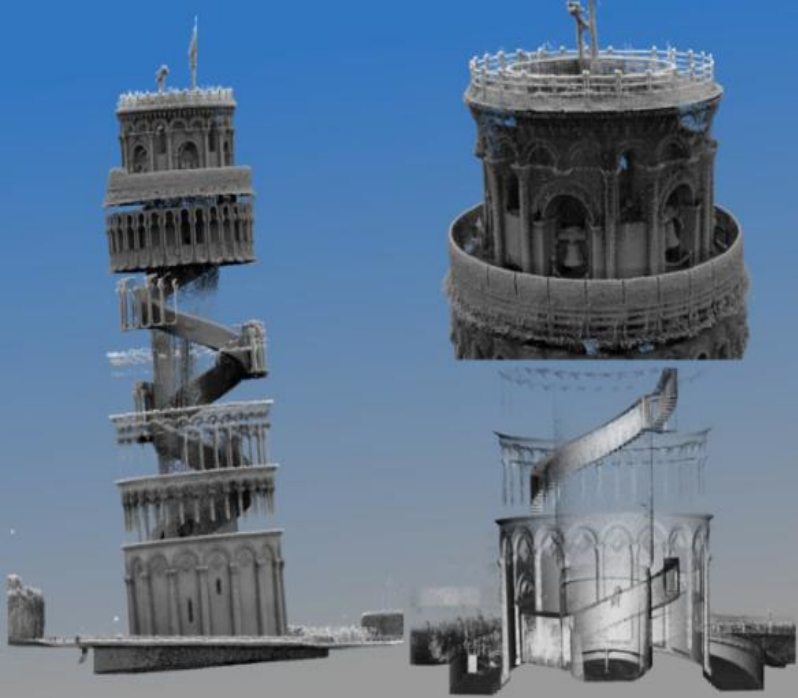

Digitise



CSIRO
2011

Hand-held
LIDAR
scanner
"Zebedee"



Connect



<http://www.themercury.com.au/news/tasmania/breakthrough-has-scientists-abuzz-over-mozzie-backpacks/news-story/714ce576103af895199f272d9b719f27>



**CSIRO
2013**

**The internet of
insects**

Personalise

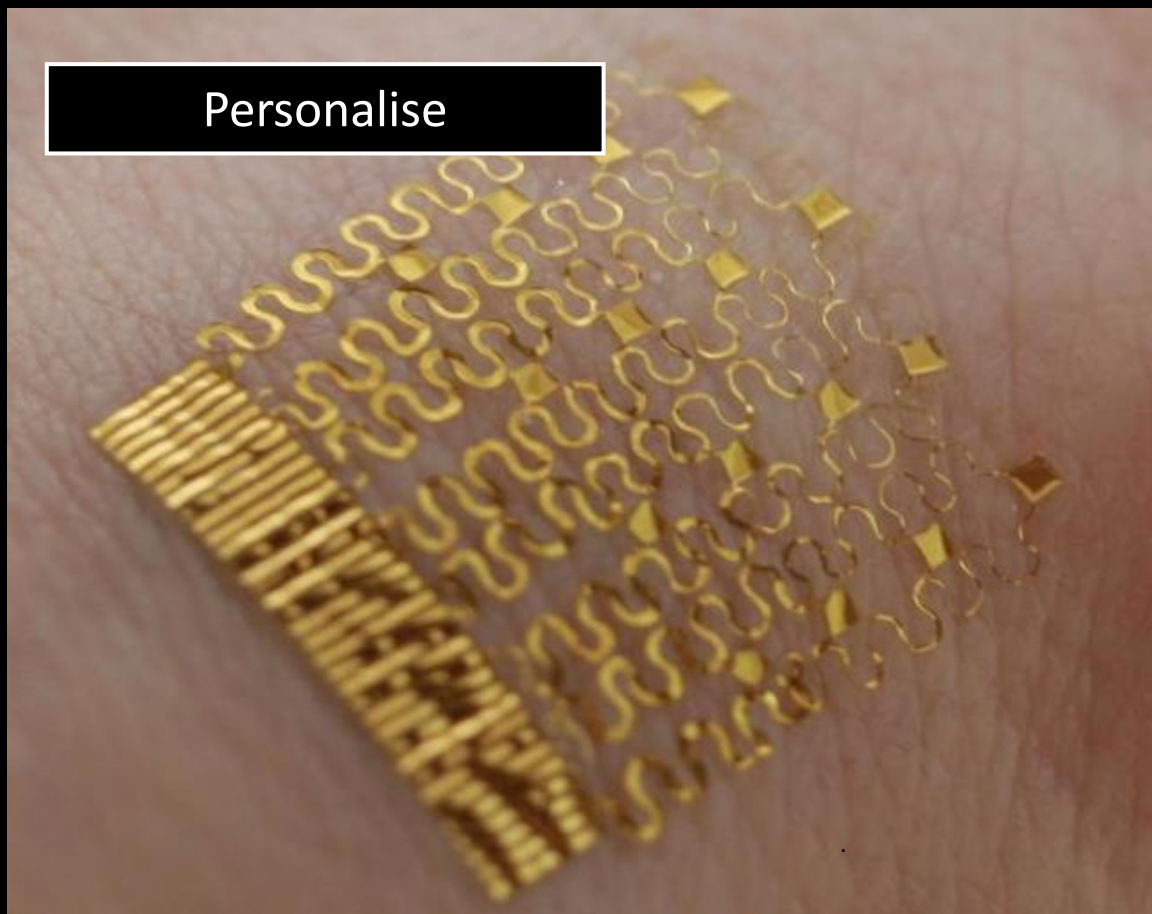

2016

The internet of patients

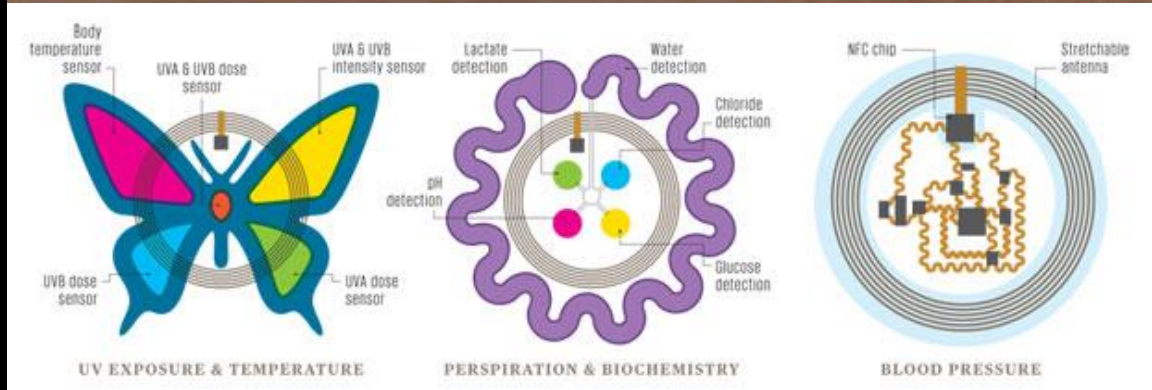
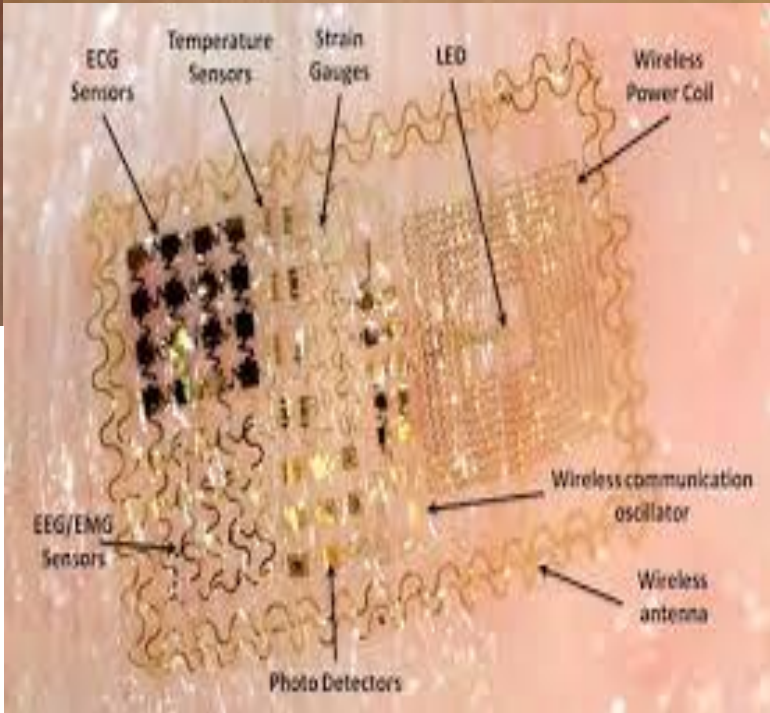

2017 – Writing to bacterial DNA (and reading it back)

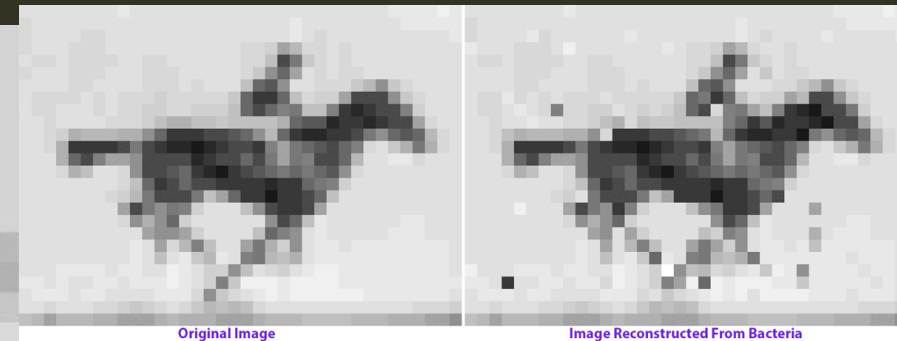
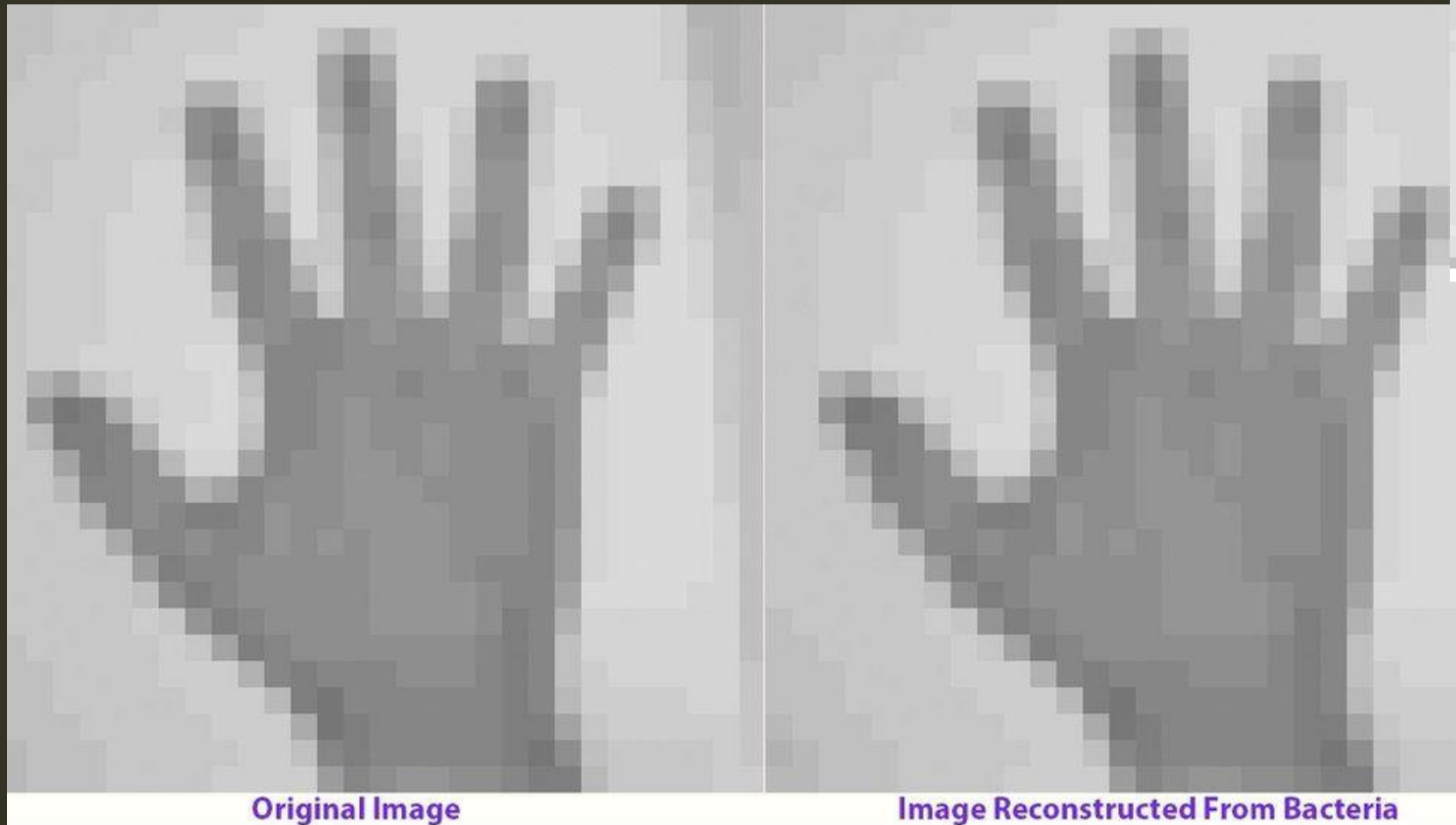

In order to insert this information into the genomes of bacteria, the researchers transferred the image and the movie onto nucleotides (building blocks of DNA), producing a code that related to the individual pixels of each image. The researchers then employed the Crispr platform, in which two proteins are used to insert genetic code into the DNA of target cells - in this case, those of E.coli bacteria. For the gif, sequences were delivered frame-by-frame over five days to the bacterial cells.

<https://www.bbc.com/news/science-environment-40585299>



Now add the Algorithm

Doing new things in new ways

THE GLOBAL
of Sustainable Dev

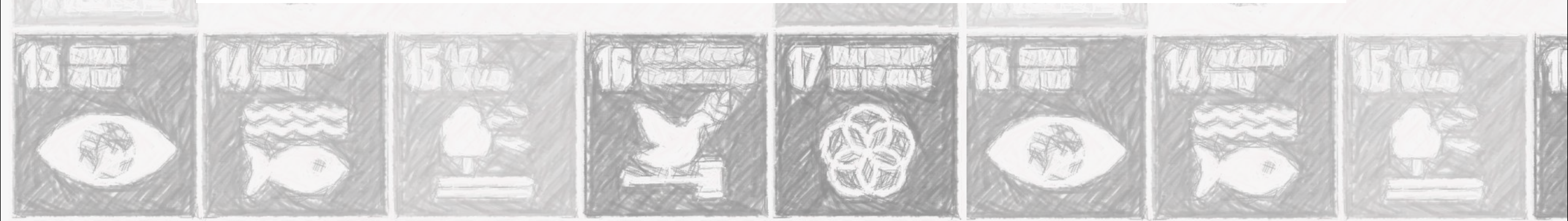

2018 Improving embryo selection using AI

Australia-based Healthcare artificial intelligence (AI) company, Harrison.ai, has upped the chance of success to 93 percent by leveraging AI trained on NVIDIA GPUs. (Reference: Human Reproduction, Volume 34, Issue 6, June 2019, Pages 1011-1018)

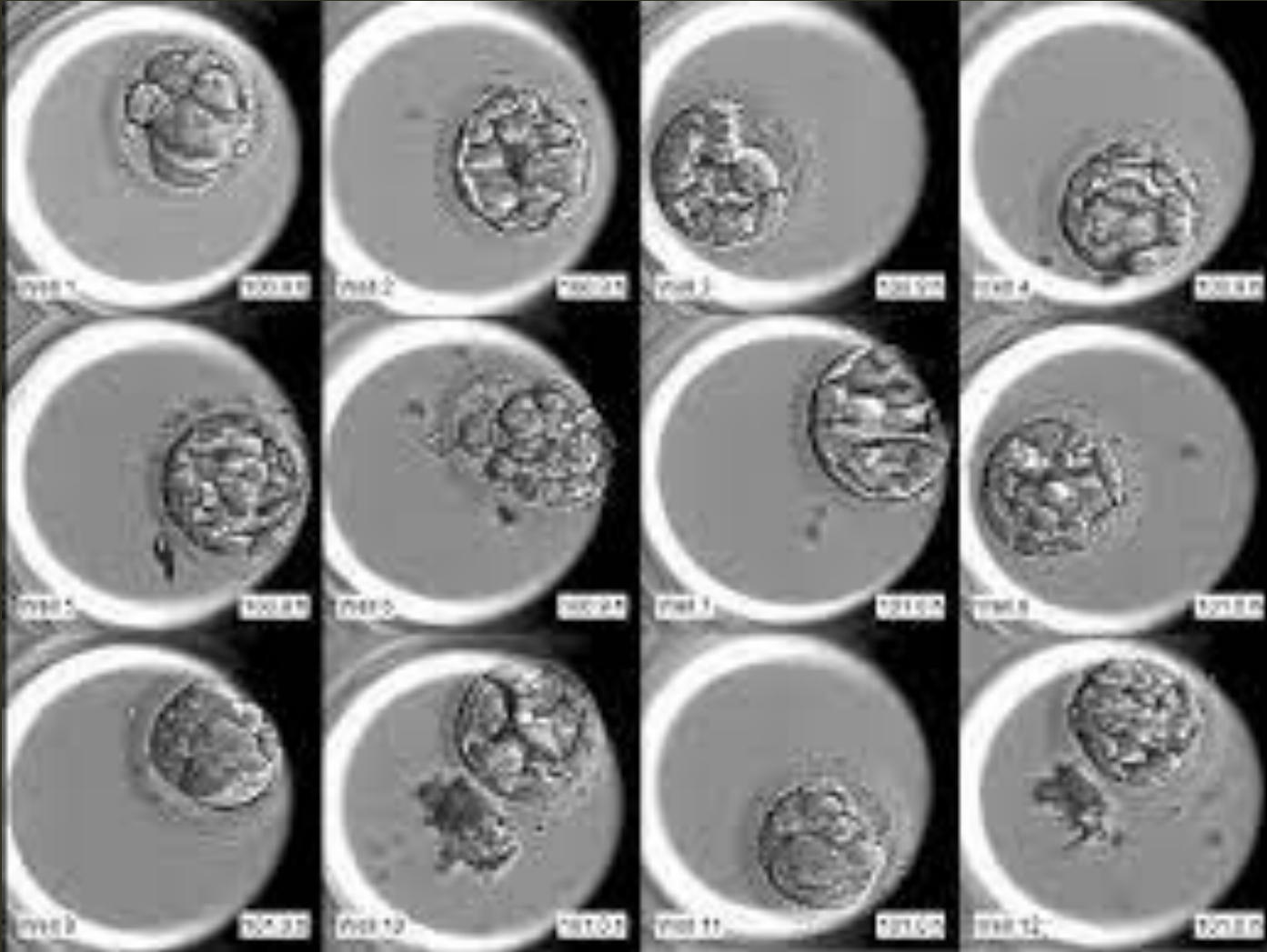

<https://newsroom.unsw.edu.au/news/science-tech/unsw-students-pioneering-artificial-intelligence-boosts-ivf-success>

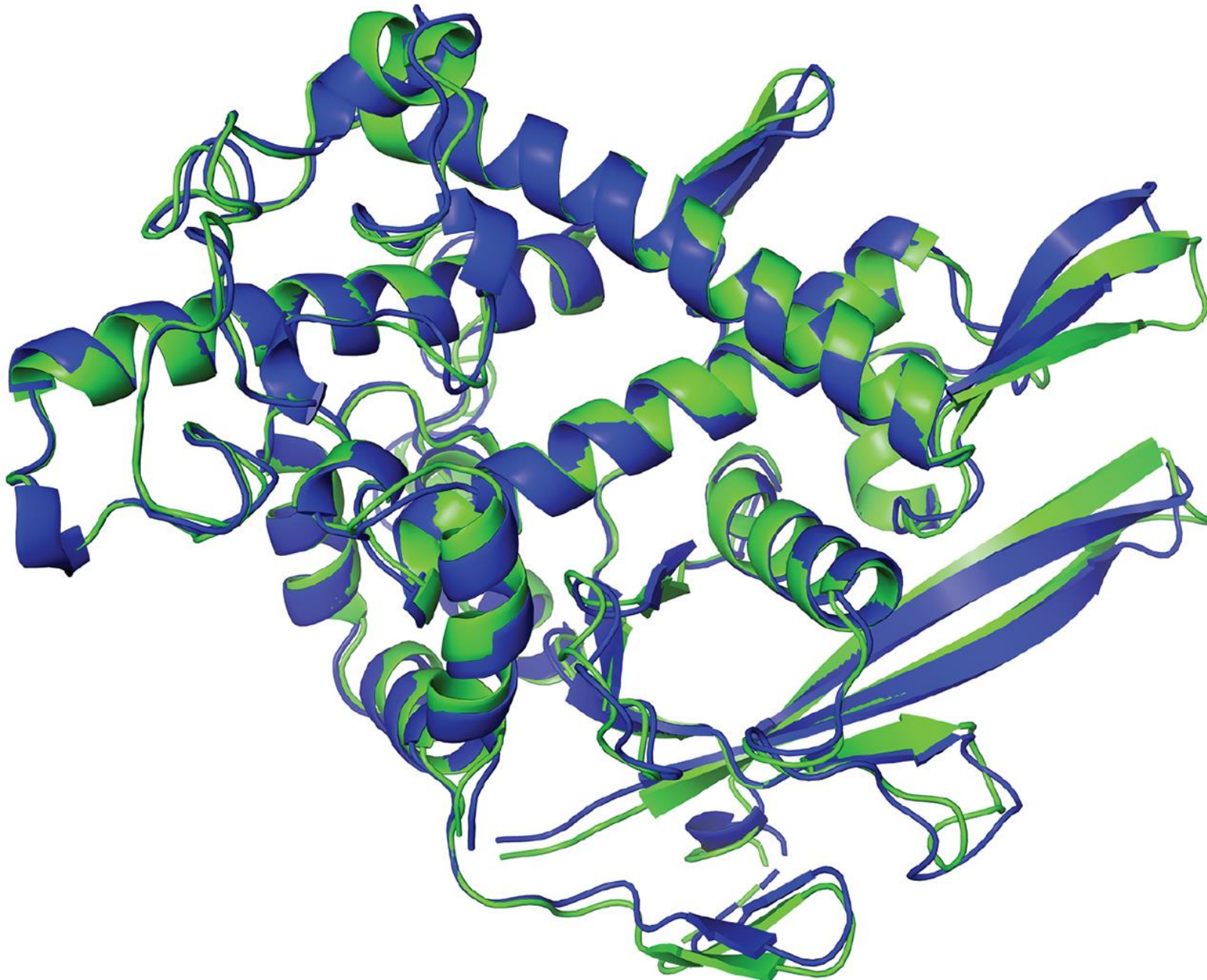

Artificial intelligence (AI) has solved one of biology's grand challenges: predicting how proteins fold from a chain of amino acids into 3D shapes that carry out life's tasks. In 2020, organizers of a protein-folding competition announced the achievement by researchers at DeepMind, a U.K.-based AI company. They say the DeepMind method will have far-reaching effects, among them dramatically speeding the creation of new medications.

2020 AI predicts how proteins fold from a chain of amino acids into 3D shapes

[https://www.science.org/doi/10.1126/science.370.6521.1144#:~:text=Structures%20of%20a%20protein%20that,\(green\)%20match%20almost%20perfectly.&text=Artificial%20intelligence%20\(AI\)%20has%20solved,that%20carry%20out%20life's%20tasks](https://www.science.org/doi/10.1126/science.370.6521.1144#:~:text=Structures%20of%20a%20protein%20that,(green)%20match%20almost%20perfectly.&text=Artificial%20intelligence%20(AI)%20has%20solved,that%20carry%20out%20life's%20tasks)

2022 NSW Health Sepsis Prediction

In collaboration with CEC, Western Sydney Local Health District (WSLHD), Sydney Health Partners, the University of Sydney and NSW Health Pathology, eHealth NSW developed a clinical decision support tool (CDST) called the Sepsis Risk Tool Dashboard that combines a patient's age, gender and vitals as they are entered into the EMR.



<https://www.ehealth.nsw.gov.au/news/algorithm-tool-to-identify-sepsis>



What Are we Doing with Data and AI?

THE GLOBAL
of Sustainable Dev

Some dynamic tensions – not opposites but not always aligned

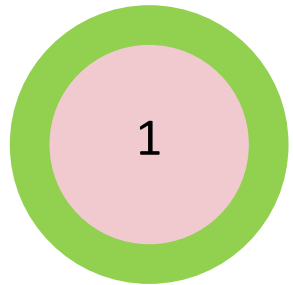

Appropriate Use

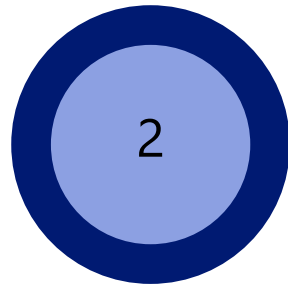

Co-Design

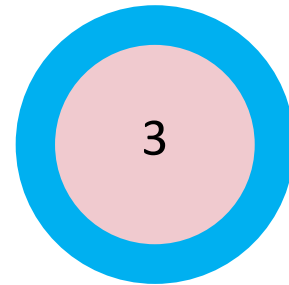

Data Considerations

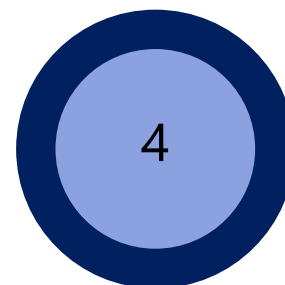

Possible Harms and Appeals

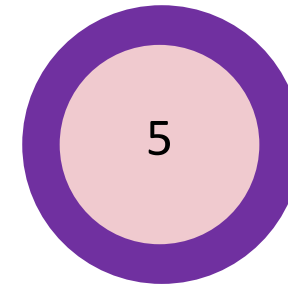

Governance Considerations

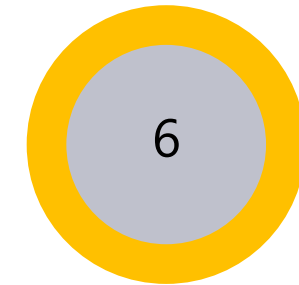

Human Attention & Cognition

Complex Enough to be Useful

Identification of Risks

Explainable AI

Assurance of “use of AI”

Human in the Loop

Ensuring Individual Responsibility is Clear

Simple Enough to be Useable

Identification of Benefits Compared to Current Practices

Powerful non-Explainable AI

Impinging on Authorising Environments

Over or Under Reliance on AI

Unduly burdening Users and Deterring AI Uptake



Data Problem, AI Problem or Policy Problem?

THE GLOBAL
of Sustainable Dev

Data Lens

Control Required in Data Environment

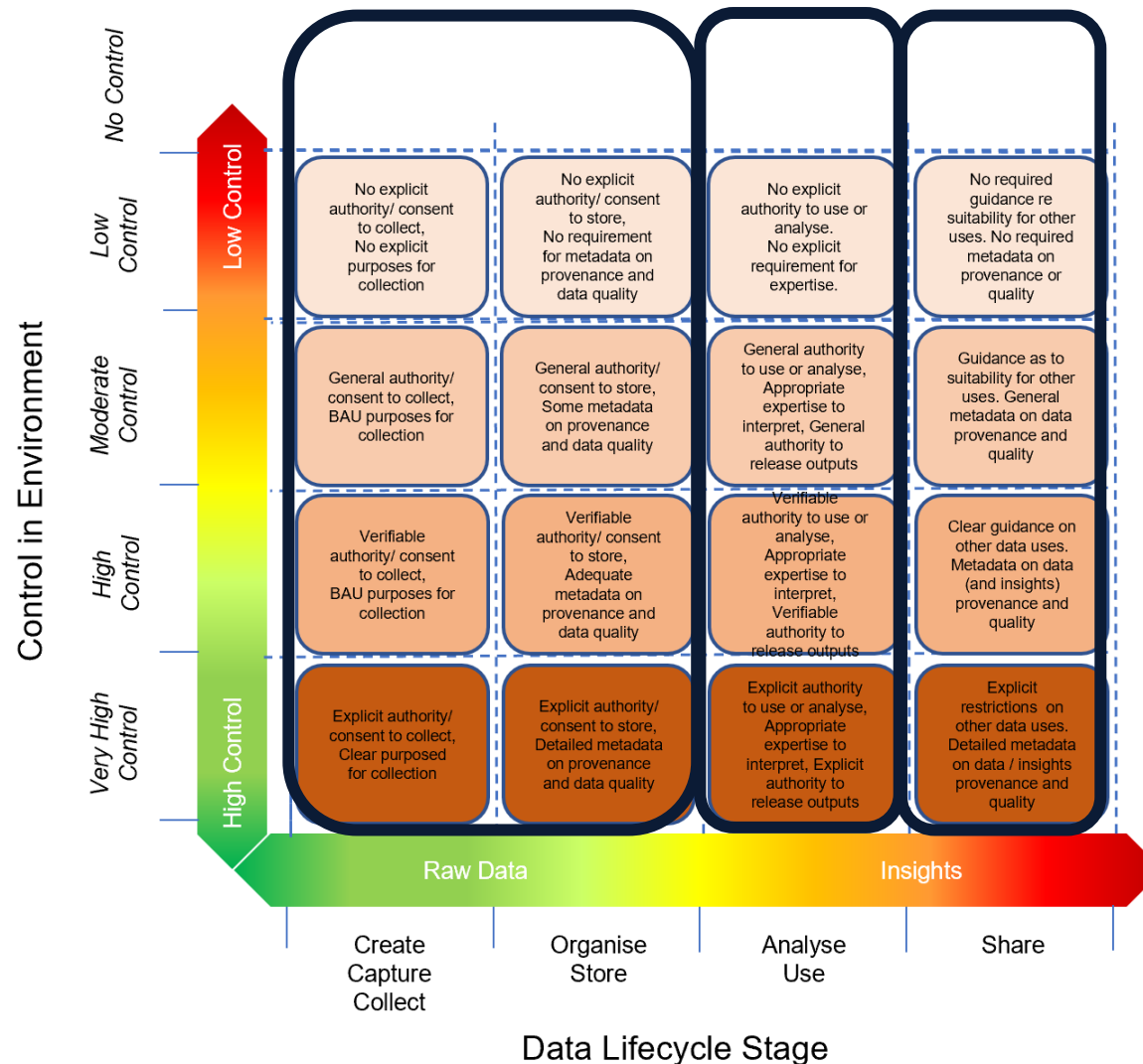
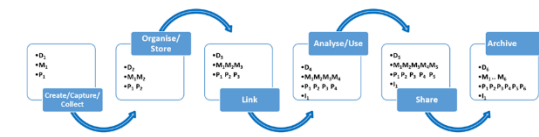

- Control = (proven) capability * (assessable) governance * (verifiable) purpose
- Capability includes skill in all stages of Data Lifecycle - data analysis, data provenance, governance, security
- High Control = skilled people working in strong governance environment with clearly authorised purpose
- No Control environment = no assessments or no restriction on people accessing or utilising data
- Requires an objective, repeatable, standardised assessment of
 - capability,
 - governance,
 - purpose,
 - data quality and provenance
 - sensitivity of data
 - degree of personal information contained in datasets



Data Problem, **AI Problem** or Policy Problem?

THE GLOBAL
of Sustainable Dev

AI Lens 1 - Operational vs non-operational AI

Operational AI

Operational AI systems are those that have a real-world effect. The purpose is to generate an action, either prompting a human to act, or the system acting by itself. Operational AI systems often work in real time (or near real time) using a live environment for their source data.

Not all operational AI systems are high risk. An example of lower risk operational AI is the digital information boards that show the time of arrival of the next bus.

Operational AI that uses real-time data to recommend or make a decision that adversely impacts a human will likely be considered High or Very high risk.

Non-operational AI

Non-operational AI systems do not use a live environment for their source data. Most frequently, they produce analysis and insight from historical data.

Non-operational AI typically represents a lower level of risk. However, the risk level needs to be carefully and consciously determined, especially where there is a possibility that AI insights and outputs may be used to influence important future policy positions.

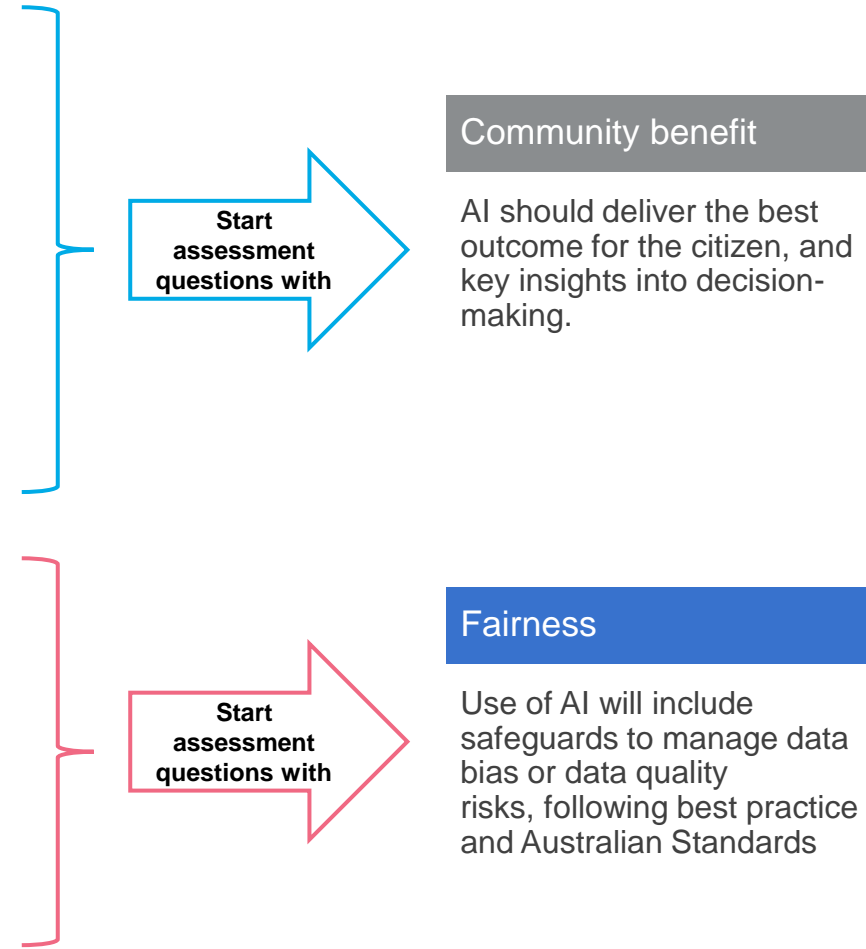

AI Lens 2 - AI risk factors exist on a spectrum

The key factor that determines risk is how the AI system is used, including whether it is operational or non-operational.

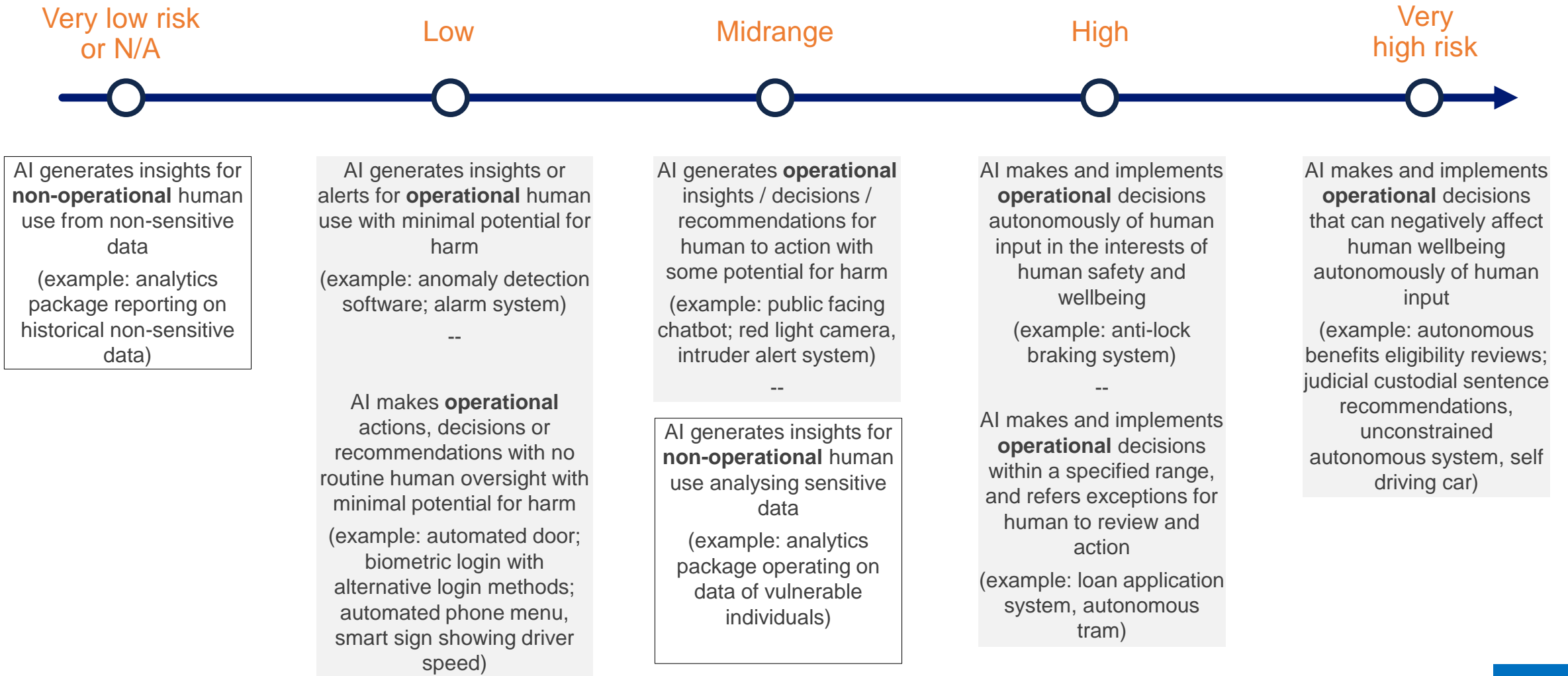

Artificial intelligence assurance framework

Time for a refresh – Version 2.0 in the works

As described by the NSW Government, Artificial Intelligence (AI) is intelligent behaviour exhibited by advanced computer systems that can learn from experience and perform tasks normally requiring human intelligence, such as making high level decisions.

AI is used for custom AI systems, and for projects developed using AI.

All AI systems should be piloted before being scaled. All AI systems should be piloted before being scaled.



December 2021
Version 1.0

<https://view.officeapps.live.com/op/view.aspx?src=https%3A%2F%2Fedit.digital.nsw.gov.au%2Fsites%2Fdefault%2Ffiles%2F2021-12%2F22112021%2520-%2520%2520NSW%2520Government%2520Assurance%2520Framework.pptx&wdOrigin=BROWSELINK>

NSW AI Assurance Framework Building into ICT Assurance

ICT Digital Assurance was set up to address ICT delivery issues in NSW Government

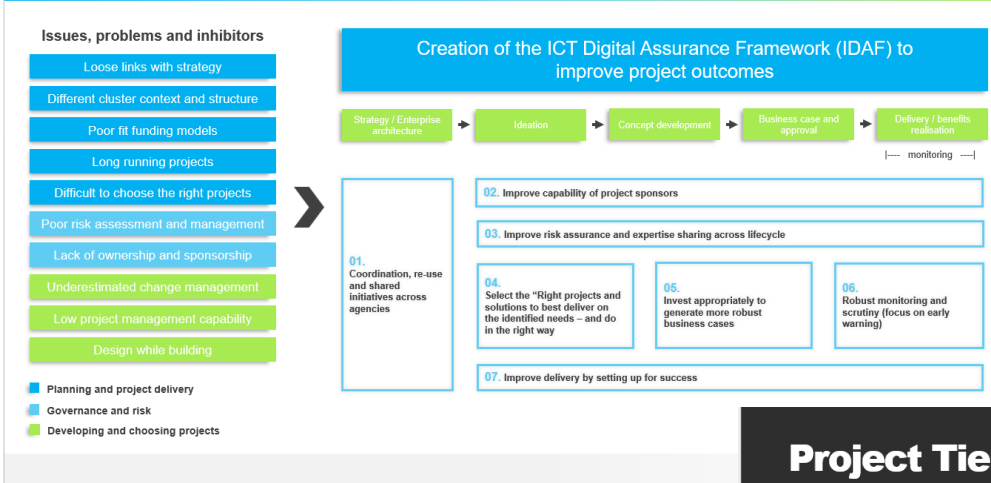

Gateway Review focus areas

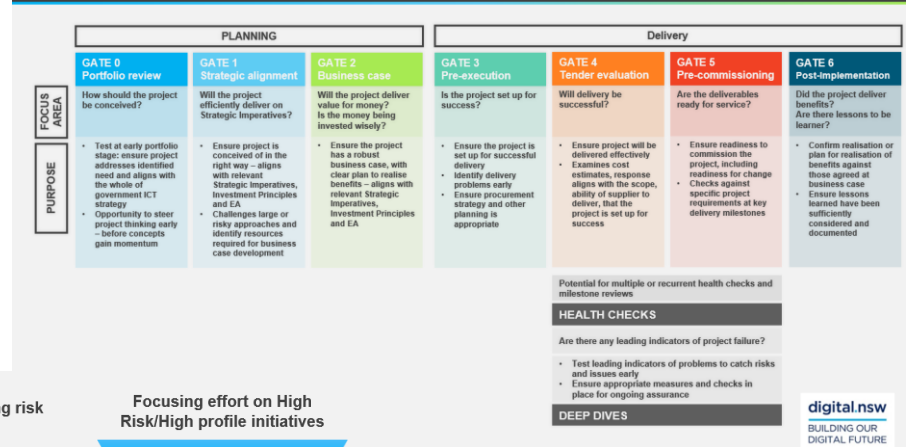

Project Tier System

Tiers are calculated based on Estimated Total Costs and Seven Dimensions of Risk

- Government priority + AI strategy?
- Interface complexity + AI risk
- Sourcing complexity + AI risk
- Agency capability
- Technical complexity + AI risk
- Change complexity
- Cybersecurity risk + AI risk (privacy, cyber)

GCIDO and Infrastructure, Services and Strategic Investment Working Group (ISSI) provide endorsement on the selected project tier



ISO/IEC/JTC1 SC42 - Developing Standards for AI



<https://www.standards.org.au/getmedia/f132c974-1ecb-4601-884d-f1e10610fbf3/Data-Digital-Standards-Landscape.pdf.aspx>



SC 42 is developing an **AI Management System as a pathway to certification**, leveraging the work that has been conducted under all the working groups.

5 standards are now published, and 21 standards and projects are under development.

Including observers, currently 47 countries involved.

SC 42 work is complemented by

Decision to Share PAS 183 (SC40) ISO 37156	Frameworks for Data Sharing Agreements SC38 23751	Appropriate Use of Analytics
Data Quality		
Terminology – Use Cases		

- Identified Standards Activities (and Gaps)
- Frameworks for Data Sharing Agreements - SC38 23751
 - Decision to Share - PAS 183 (SC40) ISO 37156
 - Data Quality - TC 184 (ISO 8000)
 - Appropriate Use of Analytics
 - Terminology – use cases
 - Utility of Metadata (SC32)

- Shorthand Legend :**
- SC27 (Cyber Security)
 - SC 32 (SQL)
 - SC 38 (Cloud Computing)
 - SC40 (Information Management)
 - SC42 (AI)

Innovation Needed

Dr. Ian Oppermann
Australian IEC NC President
IEC CB Member

e ian.oppermann@customerservice.nsw.gov.au |
2 – 24 Rawson Place, Sydney NSW Australia 2000

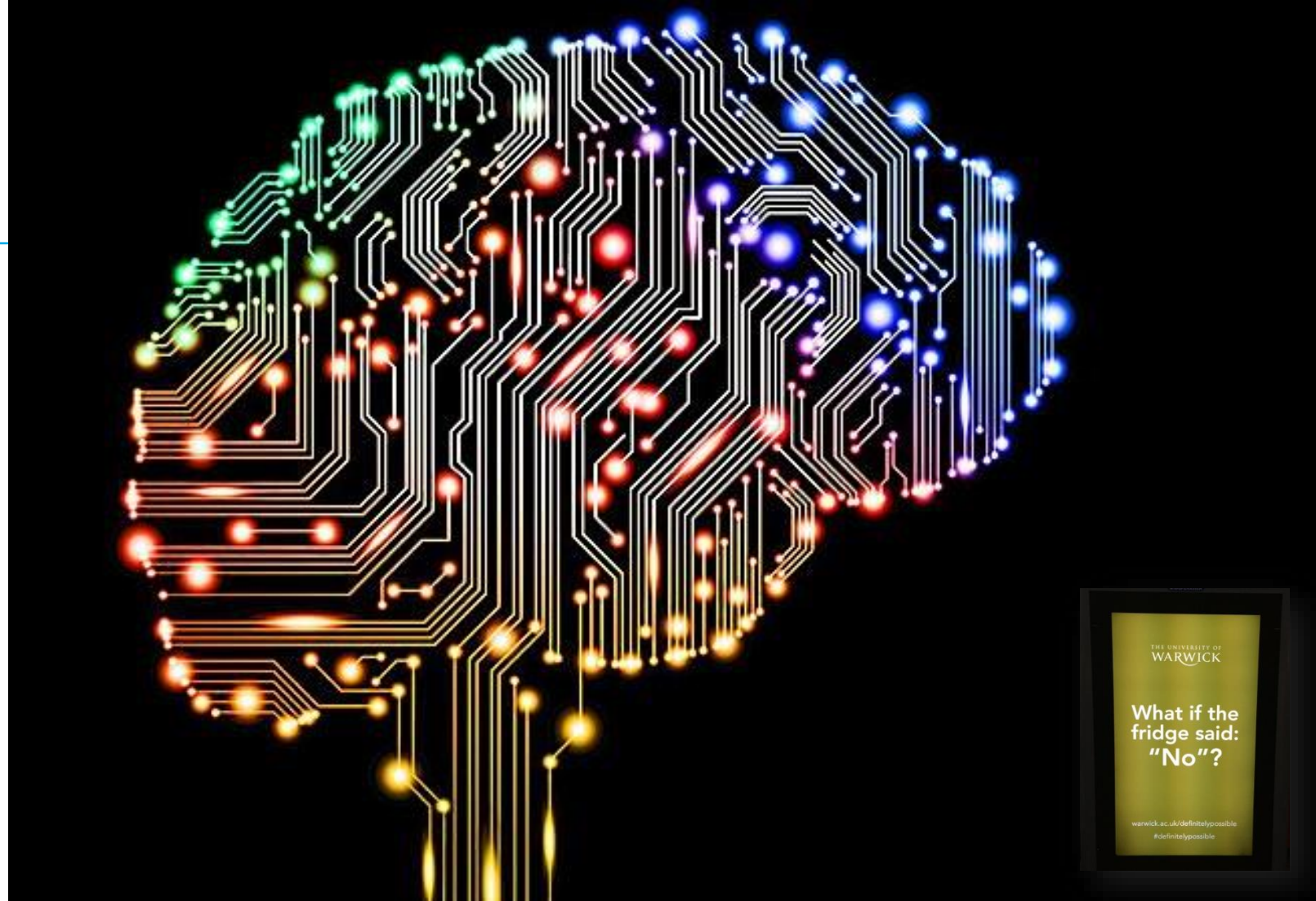

#WORLDSTANDARDSDAY



Yuntao Yu

Chair of JTC 1/SC 43
Brain-computer Interfaces

Brain-computer Interfaces Standardization Facilitate Good Health and Well-Being Worldwide

Brain-computer interfaces (BCI) technology establishes a direct connection between external devices and the human brain, enabling control and information exchange between the brain and the external environment. BCI is not only the cornerstone of next-generation human-computer interaction and human-computer hybrid intelligence, but it is also a crucial driver of the future scientific and technological revolution. Currently, BCI technology is undergoing a period of rapid technological and industrial growth. The international standardization of brain-computer interfaces will play a pivotal role in fostering a healthy industry development and aligning with the United Nations' Sustainable Development Goals. This speech provides an overview of brain-computer interface technology and the ongoing BCI international standardization efforts of JTC 1/SC 43. It also delves into how the establishment of BCI ethical guidelines can contribute to the realization of UN SDG3, promoting good health and well-being.



2023 JTC 1 World Standards Day

Brain-computer Interfaces Standardization Facilitate Good Health and Well-Being Worldwide

Yuntao YU, Chair of ISO/IEC JTC 1/SC 43

October 13, 2023

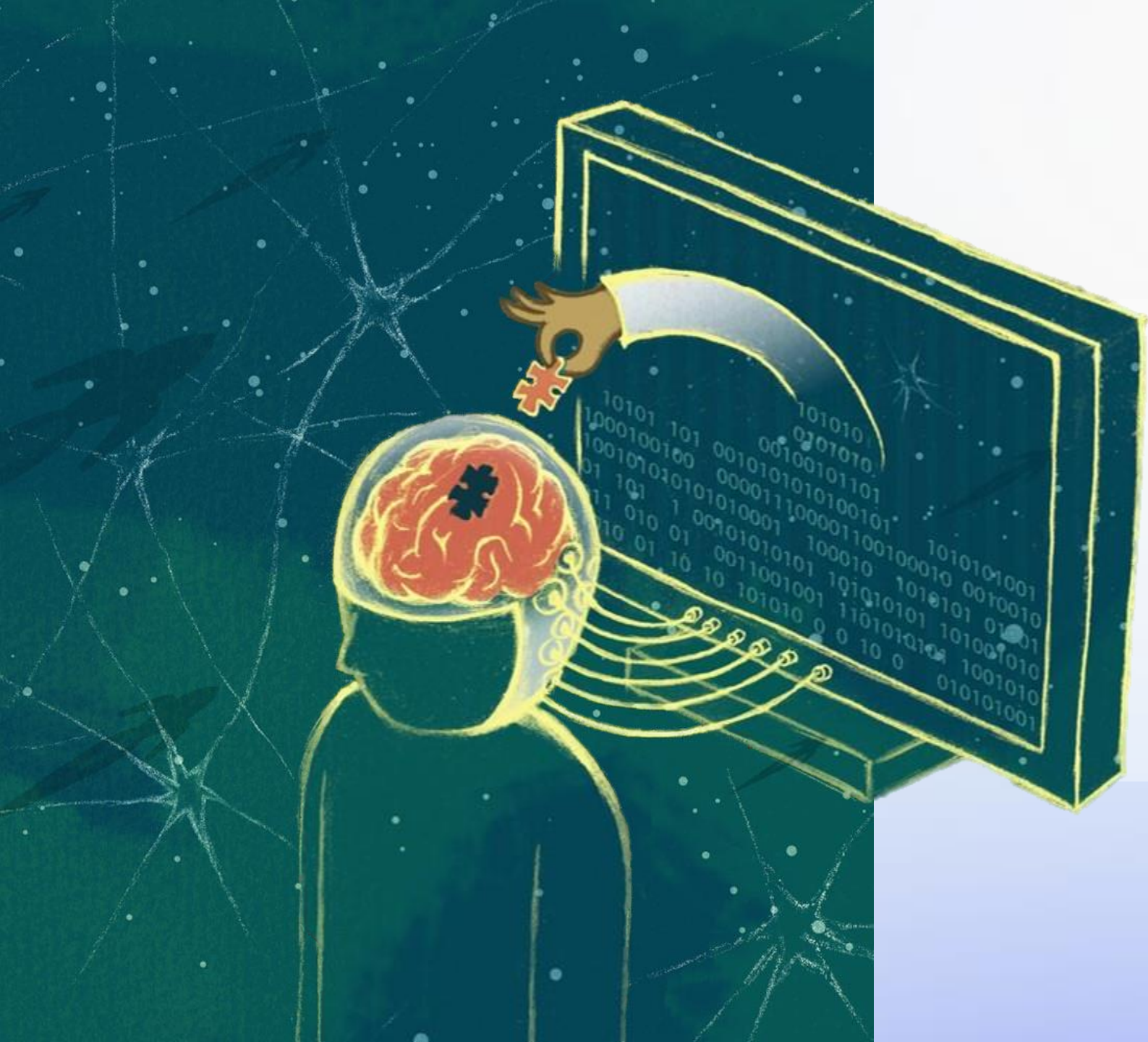

Content

1. Introduction

2. ISO/IEC JTC 1/SC 43

3. Ethical Guidelines
for BCI

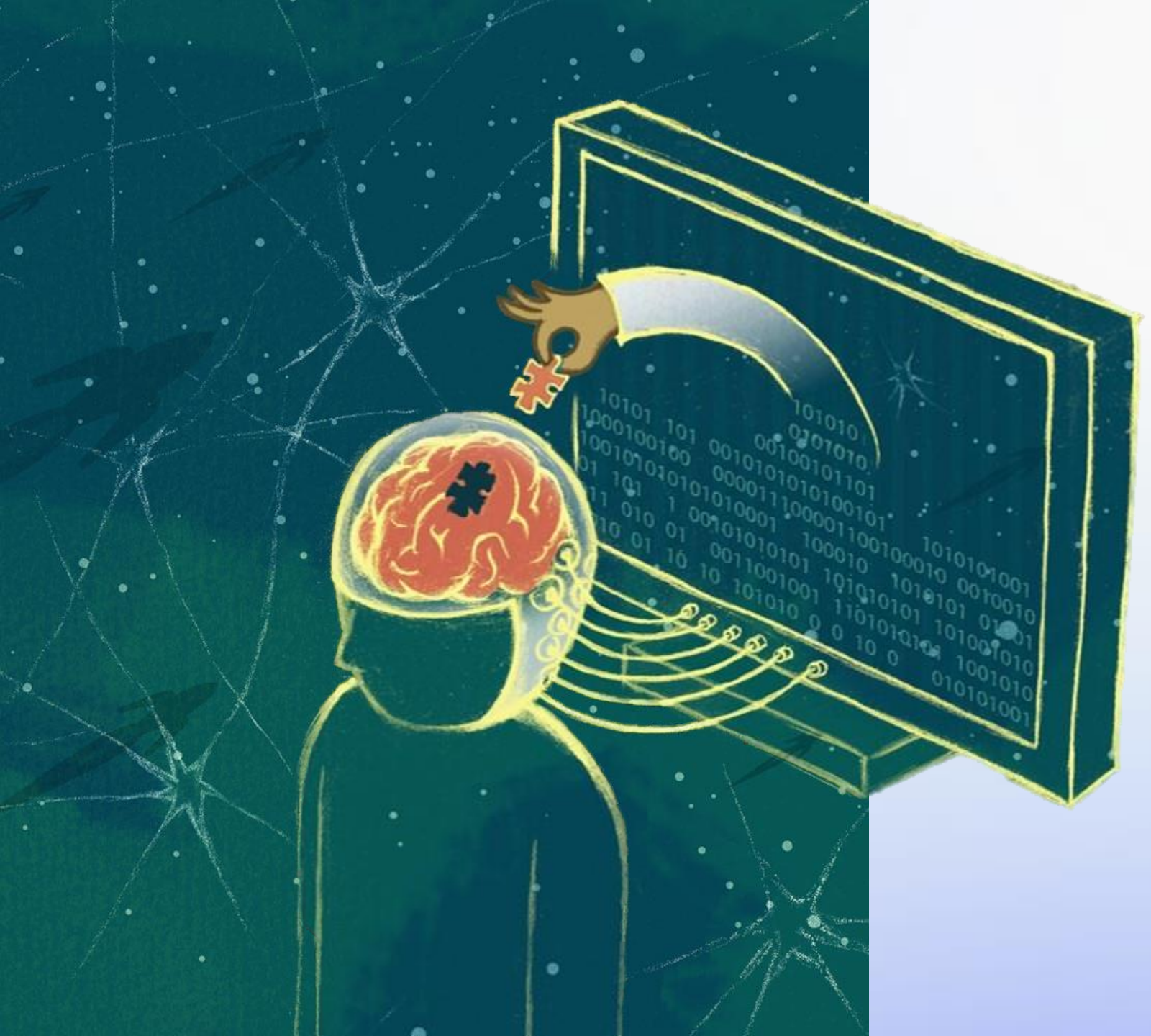

The future has come

Brain-computer Interfaces

- Technology Development
- Application Scenario
- Industry and Market
- Needs for Standardization

BCI technology development history

BCI technology: **interdisciplinarity research** that needs **multiple technical supports** (medical, engineering, and information)

Standardization Requirements

- ◆ Hardware: chip, electrode, device
- ◆ Signal acquisition, processing, and feedback
- ◆ Animal & clinical experimental paradigm
- ◆ Ethics and safety
- ◆

Multiple hardware

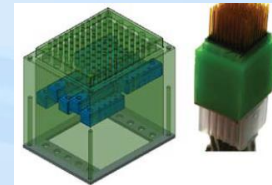

Micro wire electrode

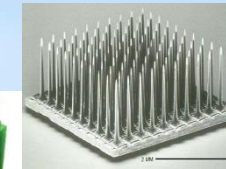

Utah Array

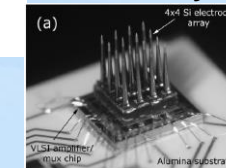

Michigan Array



Neuromorphic chip

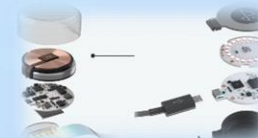

Flexible micro device

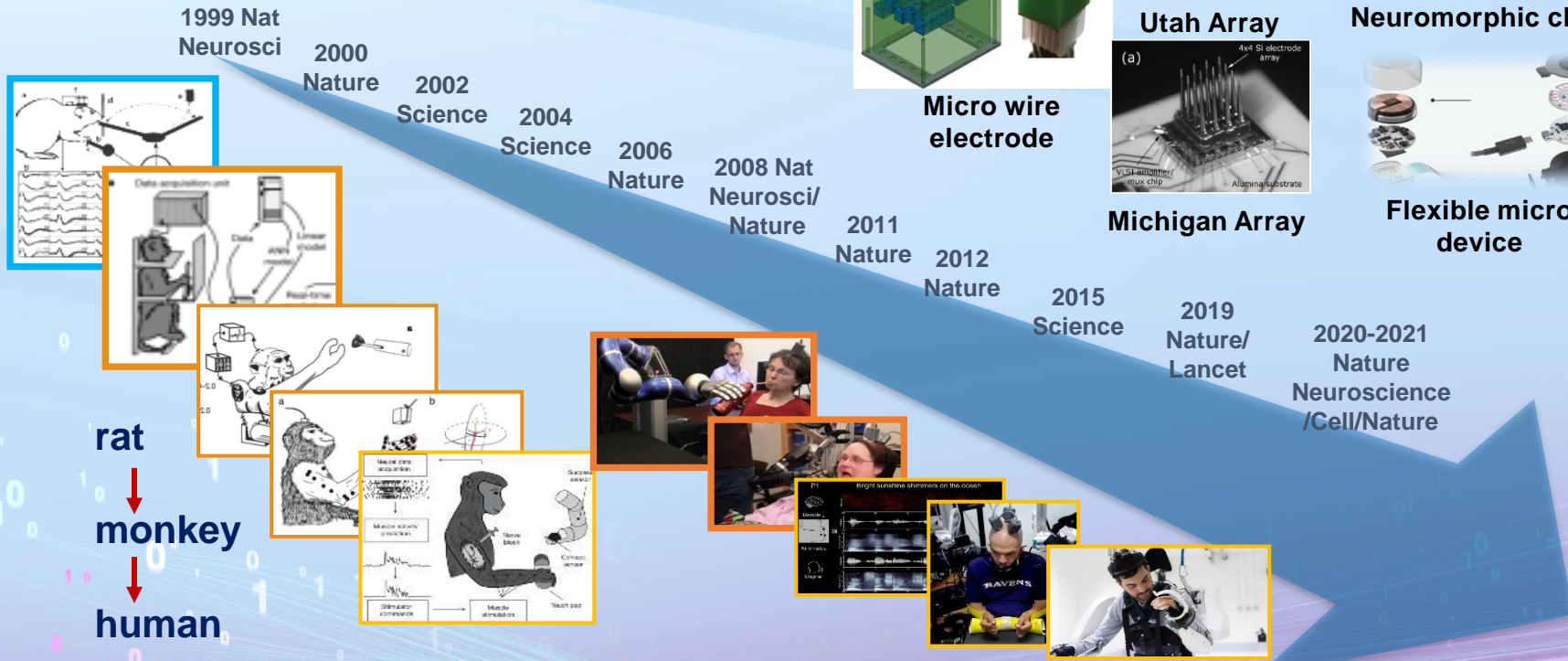

BCI has been used in many applications

Real applications **urgently needs the standardization** on BCI technology

Motor & sensing function recovery:

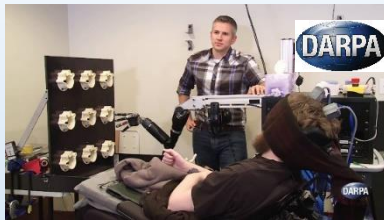

Cerebral Cortex Interface



Peripheral Nerve Interface

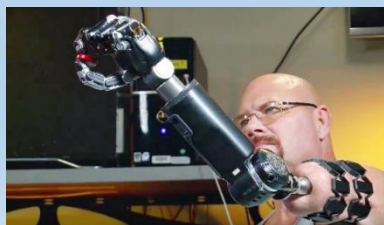

EMG Interface

Brain-controlled robotic hand

Parkinson's disease, essential tremor, epilepsy, depression, anxiety, etc.:

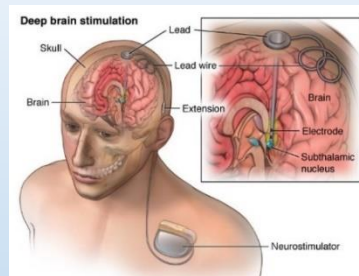

Deep Brain Stimulation (DBS)

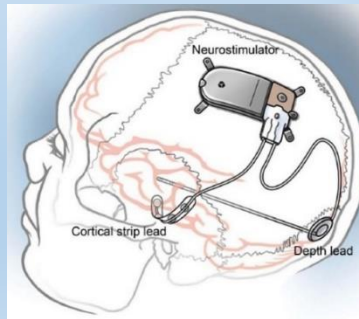

Responsive Neurostimulation (RNS)

Neurological disease treatment

Refractory frequent urination, intractable constipation, refractory pain, etc.:

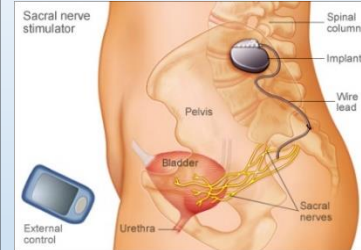

Sacral Nerve Stimulation (SNS)

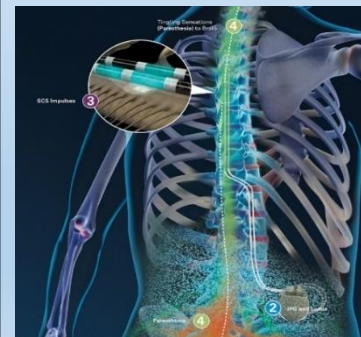

Spinal Cord Stimulation (SCS)

Neurological disease treatment

Digital medicine, education, learning, training, sleep monitoring, etc.:



EEG Based Devices

Healthcare & education

BCI has already been used for rehabilitation

Use Case in China

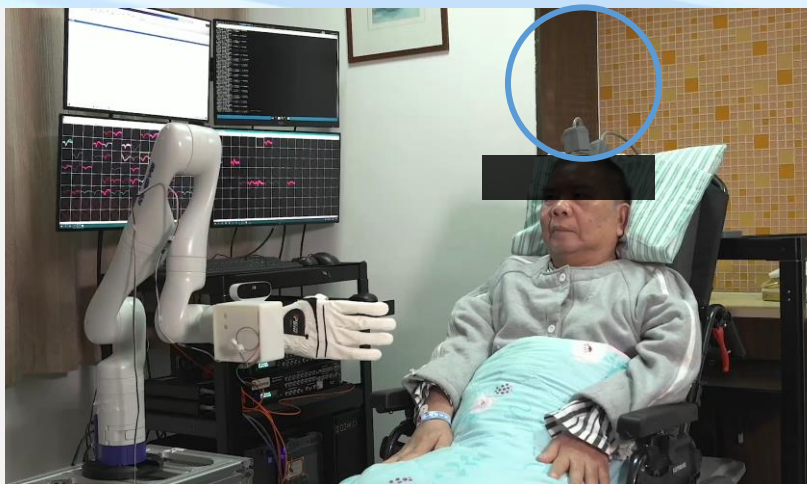

In 2020, two **Utah electrode arrays** were implanted in the cerebral cortex of China's first elderly paraplegic patient, who was 72-years old. After the surgery, he could drink Coke and ate food, via brain-controlled robotic hand.



72-years old patient played Chinese Mahjong via BCI.



72-years old patient wrote Chinese characters via the brain-controlled robotic hand.

——Use Case in China

BCI has already been used for rehabilitation

Use Case in China



Intelligent prosthesis using BCI technology realizes the movement control of the prosthetic hand by collecting and processing the surface electromyographic signals generated by human muscle movement.



Intelligent upper limb could help amputees to return a normal life and regain the sense of touch.



小时候我经常幻想我有一双手的场景

Mr. Ni was finally able to drink water, to play ping-pong, to write, to cook a warm breakfast, by “using his own “hands””.
After losing his upper limbs for more than thirty years.
——Use Case in China

BCI has already been used for rehabilitation

Use Case in China

- Hamilton Depression Scale (HAMD) suggests clinical healing of depressive symptoms
- Hamilton Anxiety Scale (HAMA) suggests a reduction in anxiety symptoms.
- Montgomery–Åsberg Depression Rating Scale (MADRS) suggests a reduction in depressive symptoms

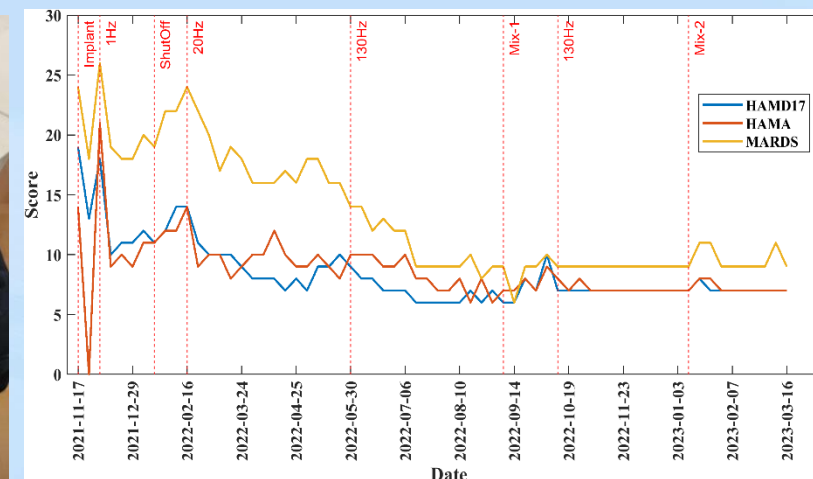
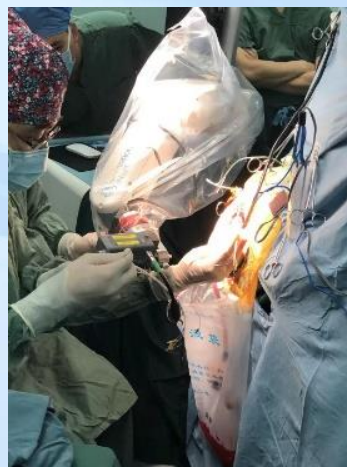

Clinical Healing Scales	Oct 11, 2021	Nov 17, 2021	Jan 13, 2022	Feb 16, 2022	May 30, 2022	Sept 5, 2022	Oct 12, 2022	Jan 9, 2023	Mar 16, 2023
Hamilton Depression Scale (HAMD)	20	20	11	14	9	6	7	7	7
Hamilton Anxiety Scale (HAMA)	16	14	11	14	10	7	8	7	7
Montgomery–Åsberg Depression Rating Scale (MADRS)	25	24	19	24	14	9	9	9	9

The BCI industry and market in the future

Typical BCI companies and their products that have appear in the market



Neuralink Chip



Medtronic DBS



NeuroPace RNS



g.tec EEG

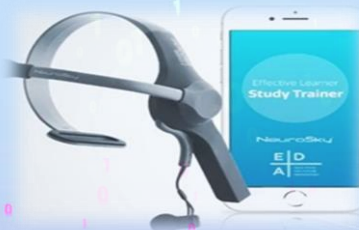

NeuroSky Learner & Study Trainer



BrainCo Headband

BCI industry chain

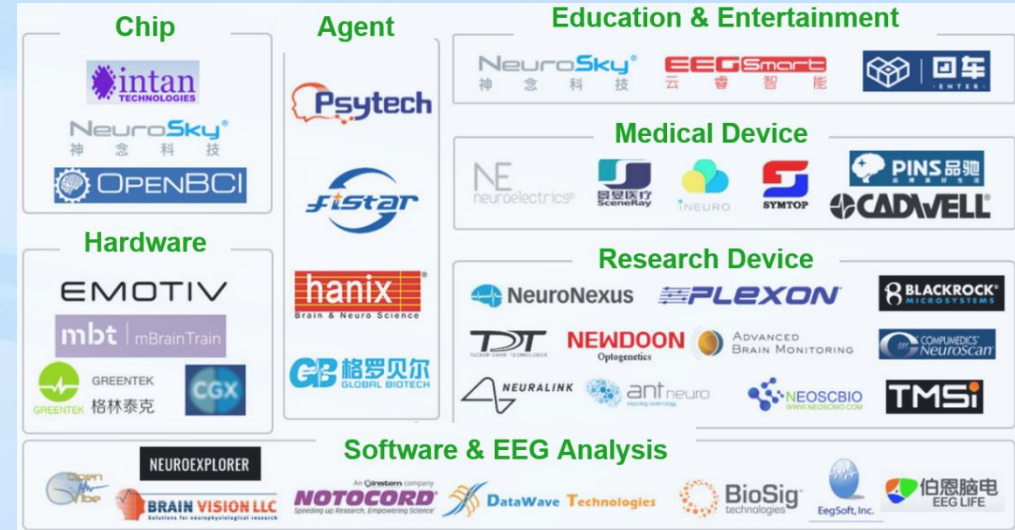

U.S. brain computer interface market size, by product, 2016 - 2027 (USD Million)

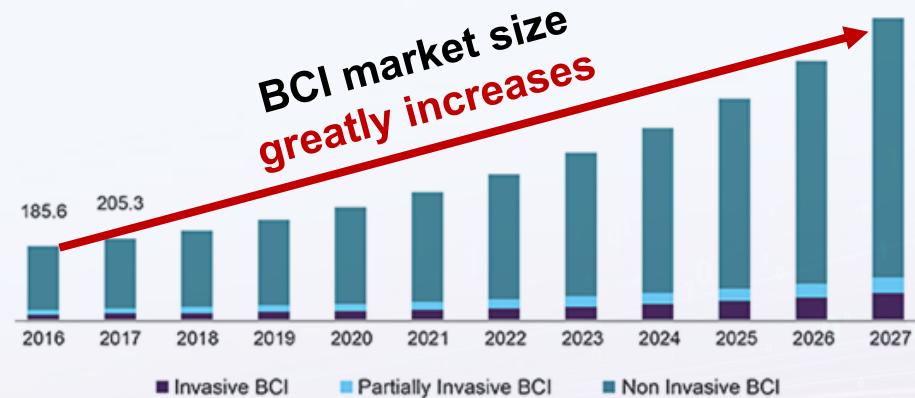

Source: www.grandviewresearch.com

An Emerging Technology

Across multiple fields and disciplines

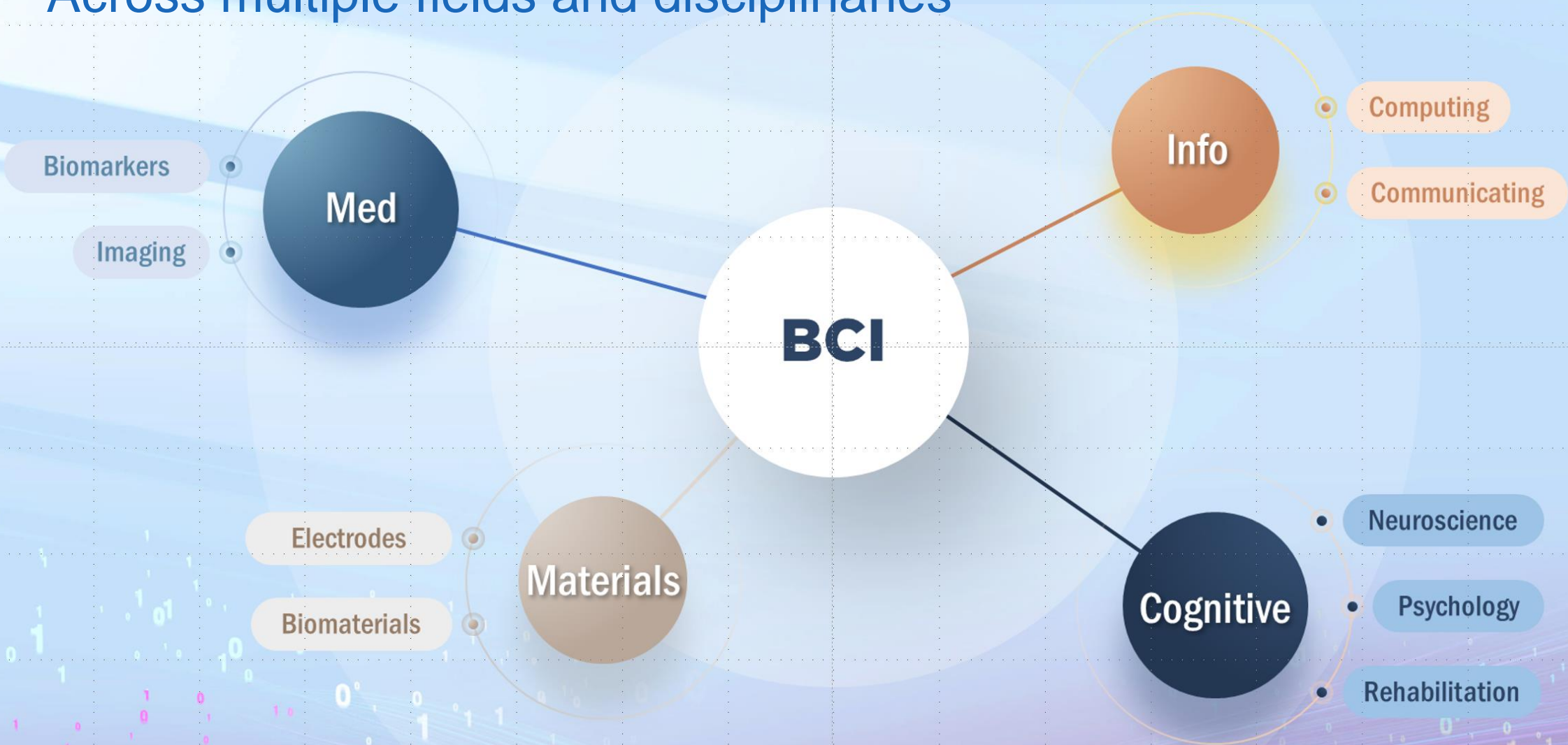

Bio Digital Convergence

New Capabilities & Possibilities

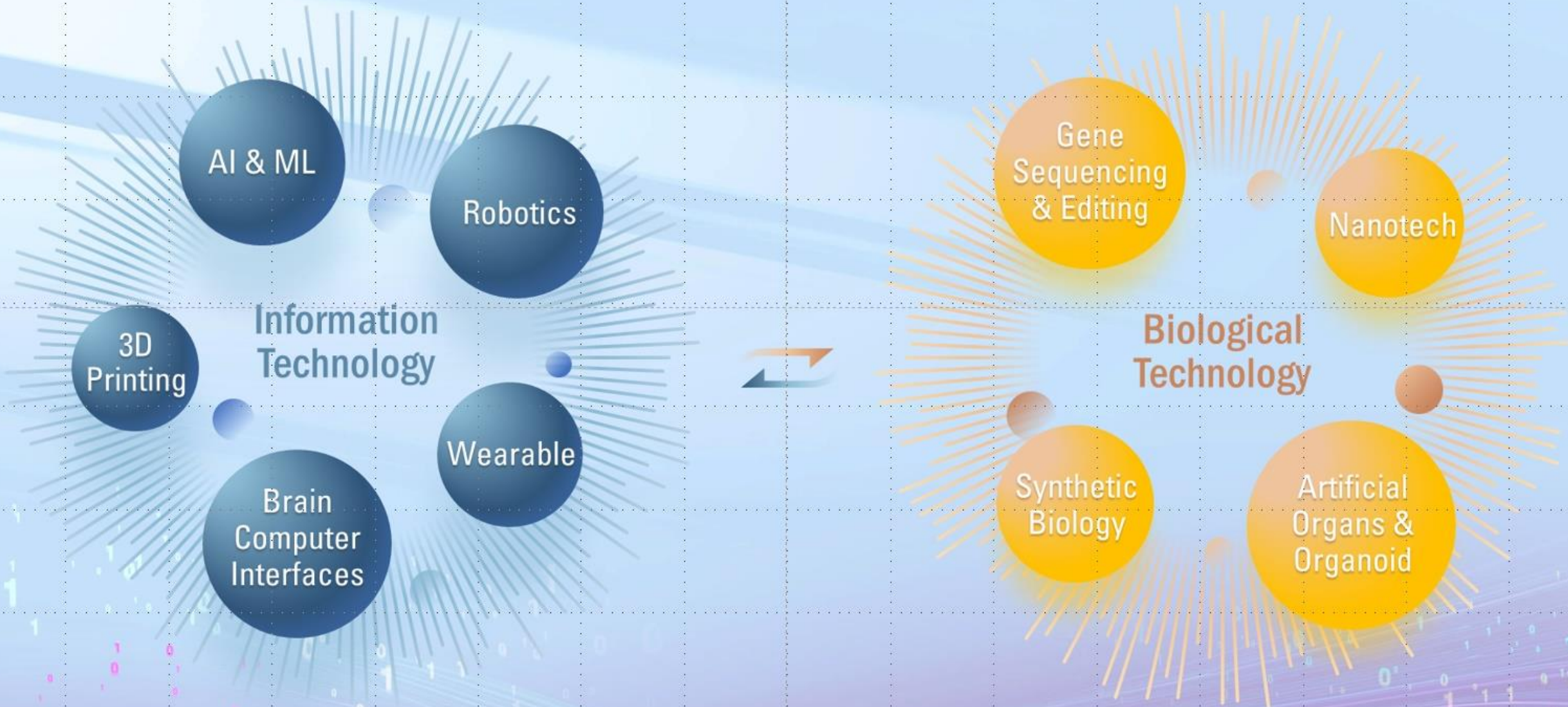

BCI technology development brings out standardization requirements



Need for Standardization

Promote greater adoption, through uniformity and interoperability.



Affordability & Scalability

Global collaboration can help drive down the costs, making BCI more accessible to people.

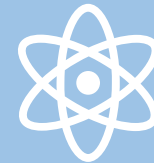

Universal Access

Ensures that BCI reaches those who could benefit from it the most



Ethical Considerations

The development and application of BCI must adhere to the highest ethical standards.

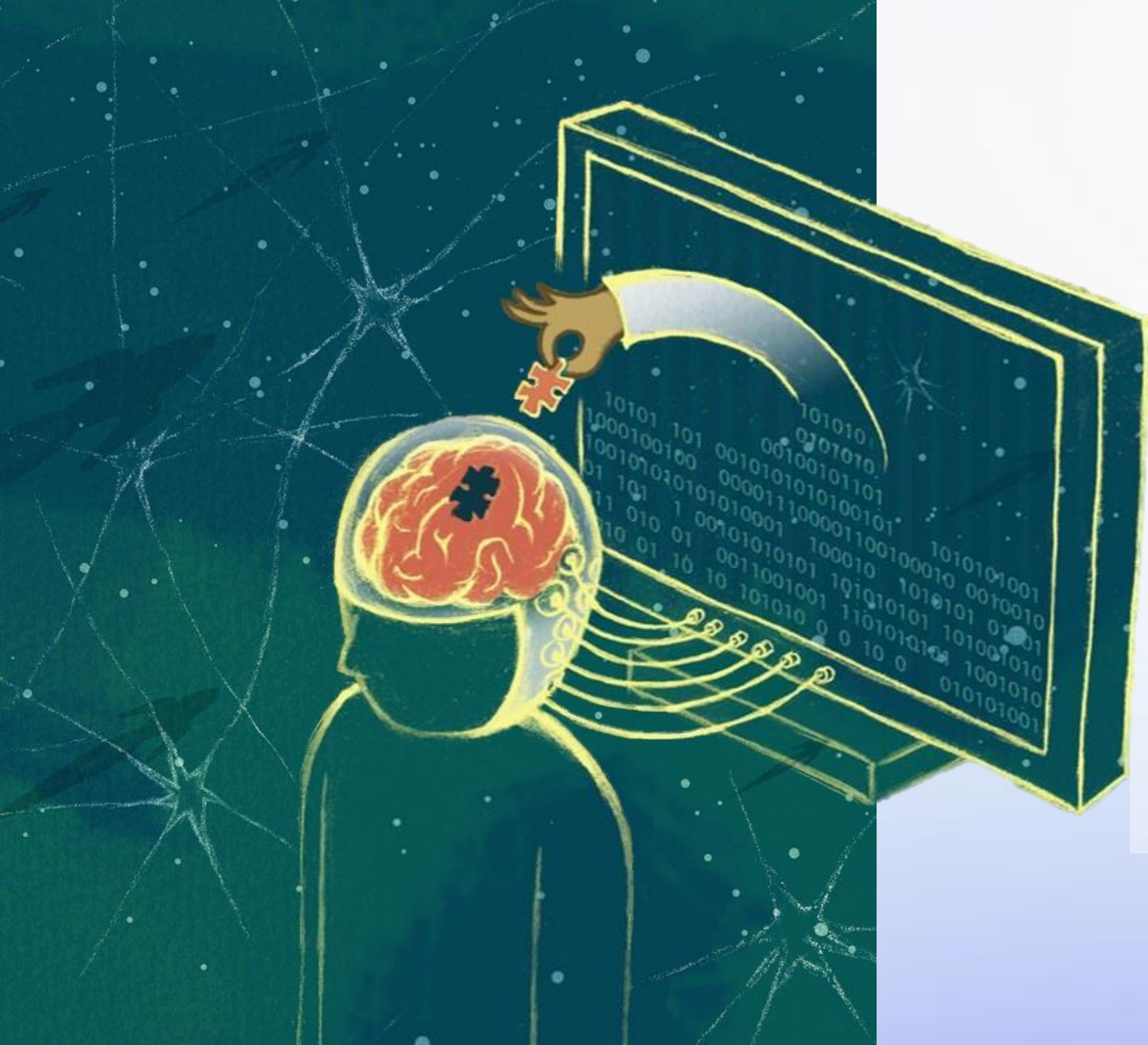

ISO/IEC JTC 1/SC 43

Brain-computer Interfaces

ISO/IEC JTC 1/SC 43 Officers

Chair: Ms. Yuntao Yu (CN)

IEC Secretariat Contacts

Technical Officer: Mr. Stephen Dutnall

Standards Project Administrator: Ms. Shewaynesh Mehari

Editor: Mr. Richard Cook

ISO/IEC JTC 1/SC 43

Worldwide Participation

9

Observer Countries

Argentina,
Austria,
Brazil,
France,
Finland,
Netherlands,
Singapore,
Slovakia,
Spain.



11

Participating Countries

Australia,
Belgium,
China,
Denmark,
India,
Italy,
Japan,
Korea,
Russia,
United Kingdom,
United States.

ISO/IEC JTC 1/SC 43

Working Groups



WG1: Foundational Standards

- Develop the foundational standards for BCI, such as a vocabulary, reference architecture;
- Align with the standing document by JTC1/AG8 (JTC 1 N16431) meta reference architecture.

WG2: Applications

- Develop the Proposed TR: Information Technology -Brain-computer Interfaces – Use cases;
- Develop use cases and applications for Brain-computer interfaces.

AG3: Chairs' Advisory Group (CAG)

- Tracks the development of technologies in this field;
- Finds the standardization requirements in this field;
- Develop business plans and roadmaps.

AG4: Liaisons & Communications Advisory Group (LCG)

- Provide support for the liaisons and communications with other SDOs;
- Strengthen the communications between SC43 and its liaisons and other SDOs.

WG5: BCI Data

- Develop BCI Data framework;
- Develop BCI Data processing regarding collection, representation, visualization, transmission and storage in BCI Data framework;
- Development in the related areas.

ISO/IEC JTC 1/SC 43

Liaisons to Other SDOs

	Description	Incoming liaison representative	Outgoing liaison representative
IEC TC62	Medical equipment, software, and systems		Mr Kim Yan Mr xu jian
IEC TC100	Audio, video and multimedia systems and equipment	Mr Hirokazu TANAKA	Mr Yun Jae Won
IEC TC124	Wearable electronic devices and technologies	Mr Jong Hong Jeon	Mr Jiangbo PU
IEC SyC AAL	Active Assisted Living		Mr Prabhat Ranjan
IEC SyC COMM	Communication Technologies and Architectures	Mr Nand Narang	Mr Nand Narang
ISO/IEC JTC 1/SC 6	Telecommunications and information exchange between systems	Mr Yun Jae Won	Mr Yun Jae Won Mr Wei Ma
ISO/IEC JTC 1/SC 41	Internet of Things and Digital Twin	Ms Erin Bournival	Mr Kim Yan
ISO/IEC JTC 1/SC 42	Artificial Intelligence		Mr John Stassner
ISO/TC 150	Implants for surgery		Ms Li Ting
ISO/TC 215	Health informatics		Mr Azizuddin Khan

ISO/IEC JTC 1/SC 43

Ongoing Projects

ISO/IEC 8663 ED1
Vocabulary

Information Technology-Brain-computer Interface-Vocabulary
Project Leader: Jiangbo PU

Technical Report
Use Cases

Information Technology - Brain Computer Interfaces - Use
Cases
Project Leader: Jiahui PAN

JTC1-SC43/72/NP
Reference Architecture

Information Technology - Brain-computer Interfaces - Reference
Architecture
Project Leader: Nan LI

JTC1-SC43/53/NP
Data Format

Information Technology - Brain-computer Interfaces - BCI data
format for Non-Invasive brain information collection
Project Leader: Kwanggi KIM

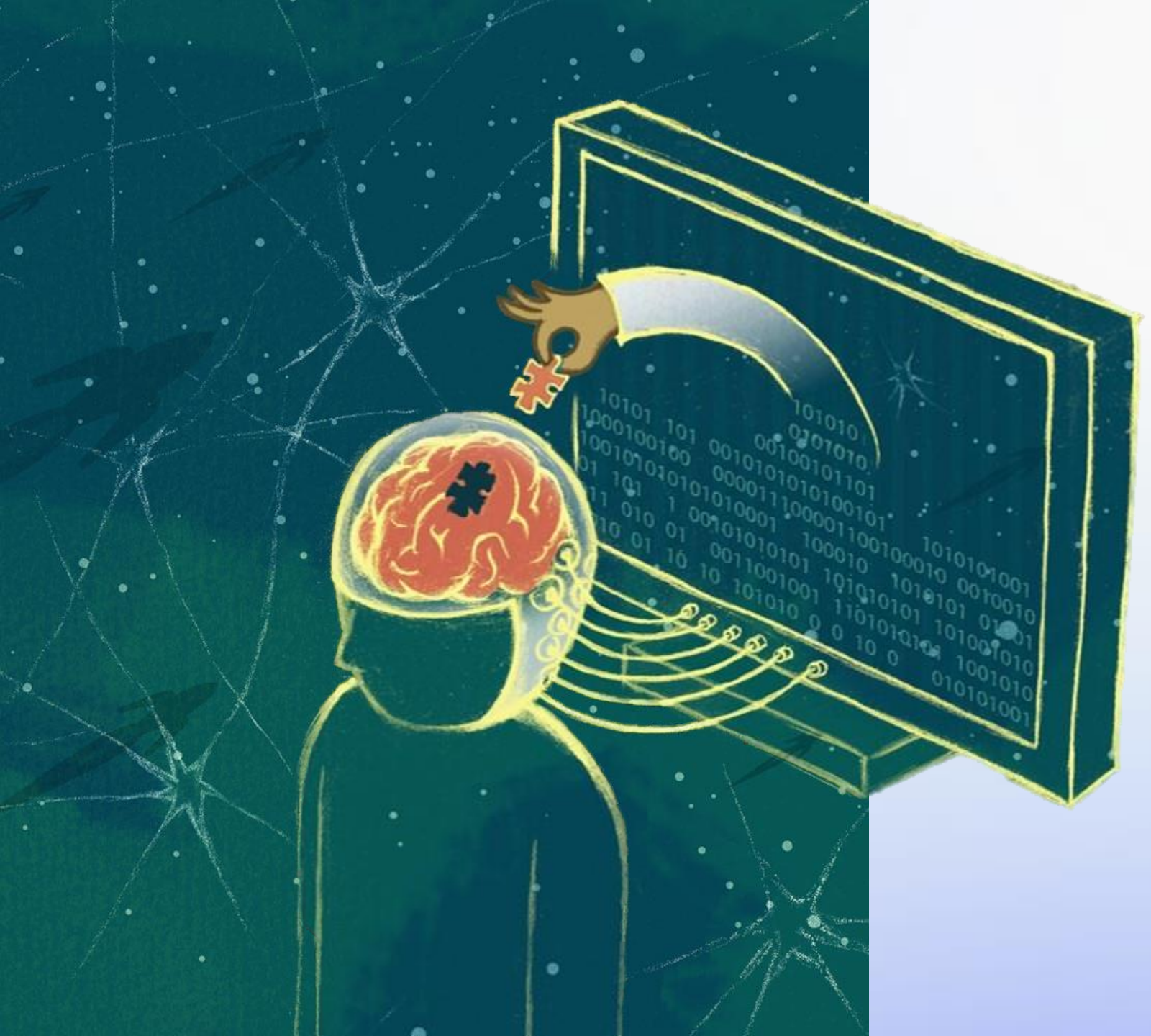

Ethical Guidelines for Brain-computer Interfaces

ISO/IEC JTC 1/SC 43

New Proposal

Ethics Issues for BCI Application

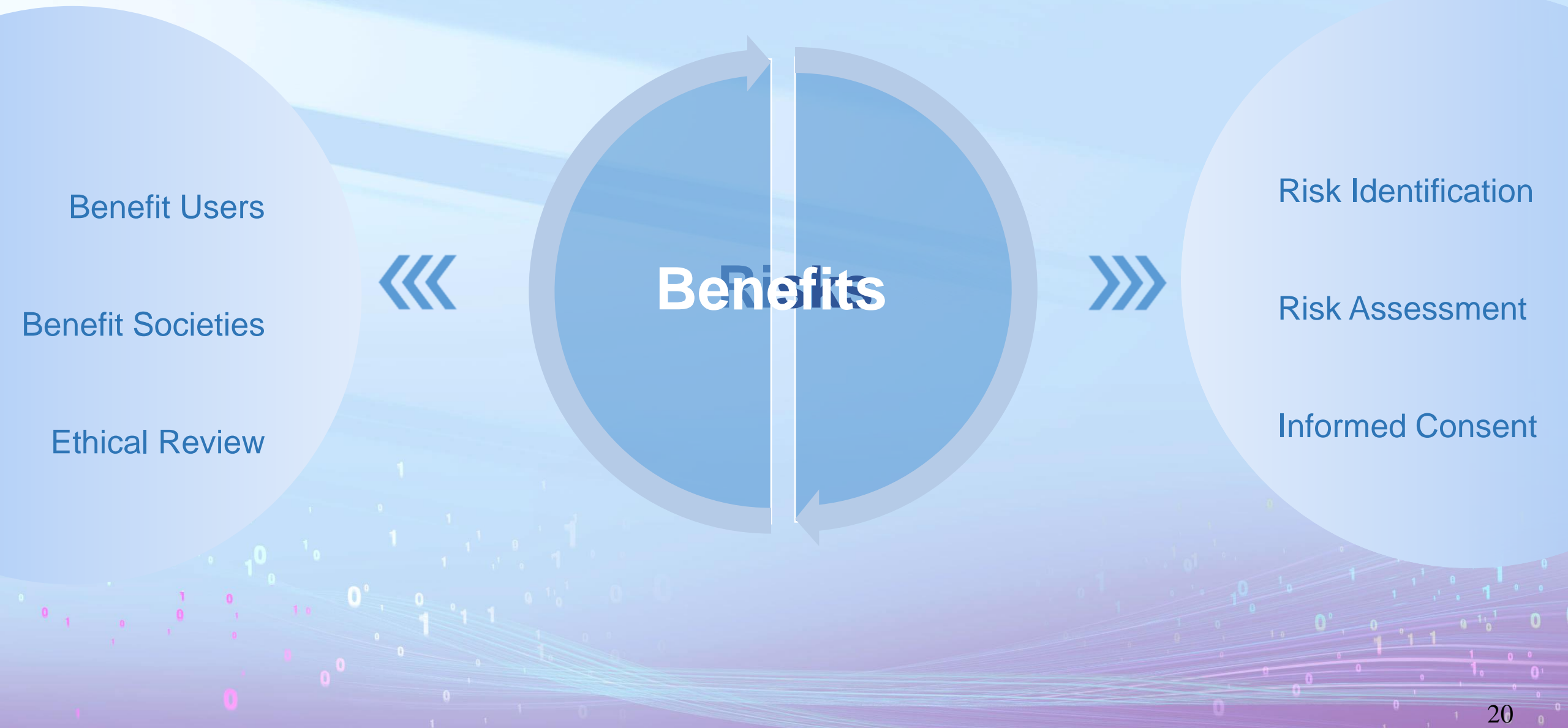

Importance of an Ethical Standard for BCI



Protecting
Rights & Privacy
of BCI users



Ensuring Safety &
Minimizing Risks



Avoiding
Unintended
Consequences



Promoting
Fairness & Equity

Maintaining Public Trust

- Development and Use in a *responsible and transparent* manner
- *Sustainable Development Goals:*
Diversity and Inclusive

Addressing Ethical Dilemmas

- Informed Consent: *Fully Informed*
- Autonomy: *Fully Understood*
- Agency: *Fully Controlled*
- Privacy
- Risk Benefit Ratio

Ethics Pillars for BCI Research, Development, & Use



Autonomy & Agency

- Individuals using BCI shall have the right to control their own thoughts and actions, which includes the right to choose whether to use the technology.
- To make informed decisions about how it is used.



Beneficence & Non-maleficence

- To act in the best interest of others and to promote their well-being.
- To avoid causing physical and psychological harm, or any other negative outcomes or injuries to individuals using BCI.



Fairness (Equality) & Justice

- Individuals should be treated equally, and that they should have access to the same opportunities and resources.
- Individuals should receive what they deserve, based on their actions and contributions.

Ethics Pillars for BCI Research, Development, & Use



Privacy

- The right of individuals to control the collection, storage, and use of their personal and neural data. The protection of users' personal and neural data from unauthorized access, use, or disclosure



Accountability

- The responsible parties and information records involved in the development, use, and maintenance of brain-computer interfaces should be recorded to ensure traceability and auditability



Social & Environmental

- The development and use of BCIs should contribute to the well-being of individuals and communities, while also minimizing negative impacts on the environment, which meets the sustainable development goals

Challenges

To reach the consensus across the world

Cross-Disciplinary Differences

Navigating diverse terms used by various disciplines involved in BCI research, requiring extensive collaboration and understanding to achieve a common language

Fast-Evolving Technology

Continually updating standardized terminology as BCI technology advances and research findings emerge, maintaining relevancy and accuracy in the field

Specificity & Comprehensibility

Creating standardized terms that are both precise and easily understood by BCI professionals, striking a balance between technical accuracy and clarity



Legal & Ethical Compliance

Acknowledging and accommodating differences in laws & regulations across countries to create a universally accepted standardized terminology.

Resistance to Change

Convincing stakeholders to adopt standardized terminology, addressing concerns and resistance to change that may arise from familiarity with existing terminology.

Language & Cultural Variations

Developing terminology that respects diverse cultures & backgrounds, while remaining accessible & understandable to a wide range of professionals.

Standardization Gaps

Existing Standards about BCI are Scatted in Different Places

- Bioethics
- Trustworthy AI
- Data Privacy: EU's General Data Protection Regulation (GDPR)

IEEE
7010-2020

Recommended Practice for
Assessing the Impact of
Autonomous and Intelligent
Systems on Human Well-Being

European
Commission

European Commission's
Ethical Guidelines for
Trustworthy AI
(BCI Sections) & GDPR

Various Publications about Brain-computer Interfaces Ethics

- The ethics of brain-computer interfaces, Nature, 571, S19-S21 (2019)
- Ethics in published brain-computer interface research, J Neural Eng. 2018 Feb;15(1):013001.
- Ethical aspects of brain computer interfaces: a scoping review.
-

Standardization Proposal

Reaching Ethical Consensus over Different Requirements

- Different Countries/Regions
- Different Types (Read or Write?)
- Different Scenarios (Education / Entertainment / ...)

Providing a Basic and Unified Framework for Ethical Evaluation

- Basic Ethical Pillars and requirements
 - Autonomy
 - Agency
 - Beneficence
 - Non-maleficence
 - Fairness
 - Justice
 - Accountability
 - Privacy
- Recommended Steps for Ethical Review and Evaluation
 - Ethical Review Board/Committee (ERB)
 - Identifying issues
 - Conducting review
 - Ongoing Monitor
 - ...
- Annex
 - Example Scales for Evaluation
 - Example Informed Consent

BCI & SDGs

Toward sustainable development goals



BCI for Sustainable Development
(IEC Board/TF3)



BCI for All Electric Society
(IEC SMB/AhG 95)



THANK YOU!

Any comment would be appreciated.

Yuntao YU
yuntaoyu2022@163.com

Cloud service customer business continuity and resilience

Presentation to World Standards Day

12 October 2023

Tyler Messa

US Expert to ISO/IEC/JTC1/SC38



ISO/NP 20996 – Cloud customer business continuity and resilience

Full Title: Information technology – Cloud computing – Cloud service customer business continuity and resilience

Scope: This document provides guidance to cloud service customers on business continuity and resilience when using cloud services.

Project Editor: Tyler Messa – US

JTC1 Committee Assignment: ISO/IEC/JTC1/SC38/WG5

Current Status: Out for NP ballot until 2023-12-05



Business continuity and resilience explained



Continuity and resilience – Requirements for a healthy society

- Disruption to business operations can have impacts which negatively affect the health and well-being of an entire country or region
- This is particularly true for organizations who operate critical infrastructure. Examples:
 - Financial services
 - Healthcare
 - Information technology
 - Energy and utilities
 - Etc.



Cloud Computing – Keeping the world running during COVID-19

COVID-19 served as a reminder that pandemics, while infrequent, can have a significant impact on business operations.

- Pre-COVID, managers responsible for business continuity and resilience typically focused on scenarios such as natural disasters, cyberattacks, insider threats, etc.
- The pandemic brought factors such as flexible computing power, high availability, disaster recovery, remote workforce management, safe return to the workplace, and business agility into focus.
- Public lockdowns and fear of venturing out in public created additional online traffic and digital business transactions. Organizations, like e-commerce vendors, had to be able to scale up capability to handle exponential workload increases in a relatively short time.



With great power there must also come – great responsibility!

Star Trek II – Wrath of Khan

Regulators are increasingly viewing cloud services as critical infrastructure. This shift is driven by the rapid modernization of systems and the growing reliance on cloud services for key functions, which has led to regulatory changes focusing on security, privacy, **resiliency and business continuity**.

As organizations continue to migrate their workloads from on-premises IT environments to cloud services, these organizations must also include cloud services as part of their business continuity, resilience and disaster recovery plans.



Cloud adoption and compliance outsourcing

In traditional on-premises IT environments, organizations retain control and ownership of the entire platform, including compliance requirements and applicable controls

However, in a cloud environment, cloud service customers have outsourced elements of their core ICT systems to a third party (e.g. CSPs)

This includes many requirements in frameworks such as ISO 22301:2019



Compliance outsourcing in action: COVID and remote work

The COVID induced transition to remote work, placed greater need to controls for identity and access management for authenticating users and applying appropriate permissions

ISO/IEC 27001 requires controls for managing access to information, which can be used to support ISO 22301's requirements for ensuring access to necessary information during a disruptive incident.

- However, some management controls, such as security log monitoring and defined processes for responding to potential anomalies can be shared between CSP and CSC
- As noted previously, ISO/IEC 27001 and 27002 are designed for traditional on-premises IT environments and do not specifically address the unique features of cloud



Cloud is a shared responsibility

Cloud providers are responsible for maintaining and protecting the cloud platforms up to a certain point. Customers, in contrast, have less visibility and control over securing their cloud infrastructure and networks than they had in their on-premises environments.

Specific responsibilities for protecting cloud platforms can change depending on deployment model

Infrastructure as a Service (IaaS)

Platform as a Service (PaaS)

Software as a Service (SaaS)

Responsibility	On-Prem	IaaS	PaaS	SaaS
Data classification & accountability	Cloud Customer	Cloud Customer	Cloud Customer	Cloud Customer
Client & end-point protection	Cloud Customer	Cloud Customer	Cloud Customer	Cloud Customer / Cloud Provider
Identity & access management	Cloud Customer	Cloud Customer	Cloud Customer / Cloud Provider	Cloud Customer / Cloud Provider
Application level controls	Cloud Customer	Cloud Customer	Cloud Customer / Cloud Provider	Cloud Provider
Network controls	Cloud Customer	Cloud Customer / Cloud Provider	Cloud Provider	Cloud Provider
Host infrastructure	Cloud Customer	Cloud Customer / Cloud Provider	Cloud Provider	Cloud Provider
Physical security	Cloud Customer	Cloud Provider	Cloud Provider	Cloud Provider

Legend: Cloud Customer (Blue), Cloud Provider (Grey)

Source: <https://learn.microsoft.com/en-us/azure/security/fundamentals/shared-responsibility>

Operations are migrating to cloud while frameworks and requirements remain on-premises

Current Standards Addressing Business continuity and resilience do not address cloud specifically.

- ISO 22301:2019 and other standards in the 223xx family do not provide clear guidance or requirements with respect to controls pertaining to BCMS specific to cloud services
- ISO/IEC 27017 which provides additional controls specifically for cloud services does not address business continuity/resilience and points to controls in ISO/IEC 27002 which are designed for an on-premises environment
- ISO/IEC 27031 provides guidelines for ICT readiness for business continuity, but does not specifically address cloud services



ISO/IEC 20996 Objective

ISO/IEC 20996 is will not introduce new cloud requirements or modify existing standards.

ISO/IEC 20996 is intended to provide cloud-native guidance for how ISO 22301 and supporting standards can be used within cloud computing to demonstrate customer business continuity and resilience



Questions?

Thank you!

Please feel free to reach out to me directly with any questions:

Tyler Messa

tmessa@sanluisvc.com

