

For The Long Run[™]

WOODWAY[®]

Motorized Performance & Fitness Treadmills

Includes the models:

4Front
Desmo
ELG
Mercury
Path
Pro
Pro XL



User's Manual

03/2016 UM-MT-EN-01

European Representative

WOODWAY GmbH
Steinackerstr. 20
79576 Weil am Rhein
Germany

Tel.: + 49 (0) 7621-940 999-0
Fax.: + 49 (0) 7621-940 999-40
E-mail: info@WOODWAY.de
Web: www.WOODWAY.de

Manufacturer

WOODWAY USA, Inc.
W229 N591 Foster Ct.
Waukesha, WI 53186
USA

Tel.: 1-262-548-6235
Fax.: 1-262-522-6235
E-mail: info@WOODWAY.com
Web: www.WOODWAY.com

Table of Contents

1	Safety	8
1.1	Important Safety Instructions	8
1.2	Description of Warning Notices	10
1.3	Safety Notices on Device	11
1.3.1	4Front / Pro / Pro XL	11
1.3.2	Desmo / ELG	12
1.3.3	Mercury / Path	13
1.4	Personnel Qualifications and Responsibilities	15
1.5	Intended Use	15
1.6	Unauthorized Modes of Operation	16
2	Introduction	17
2.1	Operating Instructions Information	17
2.2	Limitation of Liability	17
2.3	Copyright	18
2.4	Replacement Parts	18
2.5	Customer Service	19
2.6	EC Declaration of Conformity	20
3	Technical Data	21
3.1	Turning the Treadmill ON/OFF	21
3.2	Name Plate	21
3.3	Technical Specifications	22
3.3.1	4Front	22
3.3.2	Desmo / Desmo H / Desmo HP	23
3.3.3	ELG	23
3.3.4	Mercury	24
3.3.5	Path	24
3.3.6	Pro	25
3.3.7	Pro XL	26
3.4	Dimensions	27
3.5	Conditions for Use	30
3.6	Electrical Connection	31
3.6.1	North America	32
3.6.1	Germany	33
3.6.2	United Kingdom	33
4	Transportation and Storage	34
4.1	Safety Notices for Transportation	34
4.2	Flat Transportation	34
4.3	Upright Transportation	34
4.4	Transportation with Carrying Poles	34

4.5	Storage	35
5	Product Description	36
5.1	Running Surface	36
5.2	Transport System	36
5.3	Incline System	37
5.4	Dynamic Mode.....	37
5.4.1	Dynamic Mode: LED Standard Display Board	37
5.4.2	Dynamic Mode: LCD Personal Trainer Display Board	38
5.5	Power Console	38
5.6	Safety Equipment.....	39
6	Setup & Installation.....	41
6.1	General.....	41
6.2	Grounding Information.....	41
6.3	Installation.....	41
6.3.1	Adjust Leveling Feet	43
6.3.2	Completion of Installation	43
6.4	Assembly Instructions	44
6.4.1	Preparation	44
6.4.2	4Front.....	44
6.4.3	Desmo	48
6.4.4	ELG	52
6.4.5	Mercury, Path	52
6.4.6	Pro/Pro XL	57
6.5	Replacing Parts.....	59
7	Operation.....	60
7.1	For Your Safety.....	60
7.2	Practical Training.....	61
7.2.1	Professional Consultation	61
7.2.2	Warm-Up and Cool-Down.....	61
7.2.3	Proper Body Form	61
7.2.4	Training Frequency	61
7.2.5	Measuring Heart Rate.....	62
7.2.6	Calculating Maximum Heart Rate	62
7.2.7	Contact Heart Rate Measurement	63
7.2.8	Heart Rate Monitors	63
7.2.8.1	Applying the Chest Strap	63
7.2.8.2	Transmitter Function.....	64
7.3	Before Each Use	64
7.4	Switching Device On/Off	65
7.5	Using the Keypad	66
7.6	Standard Display	66
7.6.1	Display Parameters	67
7.6.2	Training Parameters.....	67

7.6.3	Description of Display Elements	68
7.7	Personal Trainer Display	70
7.7.1	Description of Display Elements	72
7.7.2	Quick Start (User-Defined Operation)	72
7.7.3	Quick Start Display Parameter	73
7.7.4	Starting a Training Program	73
7.7.5	Fitness Programs	75
7.7.6	User Programs	98
7.7.7	Fitness Tests	100
7.7.8	Military Test Programs	105
7.7.9	Saving Workouts to USB	105
8	Options and Accessories	108
8.1	Power Input 208 / 230 V	108
8.2	Handrail Controls	108
8.3	Reverse Mode (Bi-Directional Belt Control)	108
8.4	Top Speeds Upgrade	109
8.5	RS-232 Remote Computer Control	109
8.6	TV Programming, 4Front/Pro/Pro-XL	109
8.6.1	North America	109
8.6.2	Europe	115
8.7	Accessories and Services	117
9	Cleaning and Maintenance	118
9.1	Cleaning	118
9.2	Maintenance Intervals	119
9.3	Lubrication	121
9.3.1	Bearings	121
9.3.2	Running Surface Belt, Drive Axle	121
9.3.3	Drive Belt	122
9.3.4	Incline System	122
9.4	Adjusting and Calibrating	123
9.5	Disabling the Treadmill	125
9.6	Device Fuses	127
10	Troubleshooting	128
10.1	Unusual Noises	128
10.2	No Display	129
10.3	Running Surface Does Not Move	129
10.4	Free Moving Running Surface	129
10.5	Incline Does Not Function	129
10.6	Irregular or Flashing Display	129
10.7	Sources of Electromagnetic Interference	129
10.8	Interference of the POLAR® Heart Rate Monitor	130

10.9 Calibrating Belt 130

11 *Warranty Information* 131

12 *Maintenance Report*..... 132

13 *Disposal* 133

14 *Table of Figures*..... 134

My **WOODWAY** _____ arrived on _____
Model Name **Date**

WOODWAY History

WOODWAY's history begins in Germany in 1974. Willi Schoenberger, a technical director in charge of planning a fitness center, noticed that the most important piece of equipment, the treadmill, didn't meet the most important requirements: a mechanically sound machine that is designed to meet human needs.

He envisioned a comfortable walking surface that didn't interfere with the natural biomechanics of running or walking. Also, he wanted a transportation system which eliminated the friction associated with conventional conveyor-belt treadmills. After intensive research, and trial and error (and in cooperation with the Deutsche Sporthochschule in Cologne, Germany), Willi developed and patented a very unique and revolutionary treadmill design.

In 1975, WOODWAY GmbH was founded in Weil am Rhein, Germany. The name "WOODWAY" is derived from the German "Waldweg" ("Wald" = wood and "Weg"= way), the feel of running on a soft pine needle covered path in the forest.

In 1983, a manufacturing license was awarded to Sakai Medical, for the use of WOODWAY technology in the Japanese marketplace.

In 1988, a U.S. license was granted to a small, well-established manufacturing company in Waukesha, Wisconsin. WOODWAY USA was formed when the U.S. incarnation of the WOODWAY was developed and completed in 1990. WOODWAY USA is proud to be the primary manufacturer of WOODWAY treadmills worldwide, exporting treadmills for international distribution, in addition to serving our domestic customers and clients.

Today, WOODWAY's design and manufacturing facilities in the United States, Germany, and Japan make WOODWAY the largest specialized treadmill manufacturer in the world. Constant enhancements in quality, design, and function are shared and implemented by all three WOODWAY manufacturers.

As WOODWAY moves forward, attention to product quality, innovation, and customer service are at the forefront of our efforts. Along with our treadmills, other products, services, and strategic relationships are being developed so as to keep WOODWAY on the leading edge as we meet fitness training, testing, and rehabilitation needs.

1 Safety

1.1 Important Safety Instructions

The treadmills have been reliably designed, manufactured, and tested according to the latest state of technology and are in safe and technically perfect condition. Nevertheless, the devices can cause risk to persons and property if operated improperly.

For this reason, the operating instructions should be read completely and safety instructions must be observed.

Warnings attached directly to the device must be observed and kept in a legible condition.

Inappropriate use will result in the rejection of any liability or guarantee claims by WOODWAY.

A safety sign has been included with your treadmill. It is the responsibility of the owner to post this sign in a visible area near the machine.

All WOODWAY treadmills are built to the specifications of and are intended for both commercial and residential use.

Read all instructions before using the treadmill.

DANGER- To reduce the risk of electrical shock:

- Do not modify the plug provided with the treadmill. It is equipped with a grounded power cord. If it will not fit in the outlet, have a proper outlet installed by a qualified electrician.
- Never operate this appliance if it has a damaged cord or plug, if it is not working properly, or if it has been damaged. Contact WOODWAY or authorized service agent for servicing or assistance.
- Do not use any adapters, especially those without grounding provisions. Doing so could potentially result in electrical shock.
- Do not operate motorized treadmills in damp or wet locations.
- Do not operate the heart rate monitor transmitter in conjunction with an electrical heart pacemaker. The transmitter may cause electrical disturbances.
- Always unplug the treadmill immediately after using and before cleaning or servicing.
- Do not soak the treadmill surfaces with any liquid; use a sprayer or damp cloth.
- Keep all electrical components, such as motor, power cord, and power switch away from water.
- Do not place any open liquid containers on any part of the treadmill. The use of sport bottles with closeable tops is acceptable.
- Do not attempt to service your treadmill yourself without first contacting WOODWAY Service.
- Consult your physician before beginning Always keep the running surface clean and clear of obstructions

CAUTION:

- Any exercise program, especially if any of the following pertain to you: history of heart disease, high blood pressure, diabetes, chronic respiratory disease, elevated cholesterol, smoker, experiencing any other chronic disease or physical impairments.
- Pregnant women should consult their physician before beginning an exercise program.
- If you experience dizziness, chest pain, nausea, or any other abnormal symptoms while using the treadmill, stop training immediately. Consult a physician before continuing.
- A qualified mechanic should perform any service or repair work. It is preferable that mechanics have successfully completed WOODWAY factory-authorized service school or equivalent.

WARNING- To reduce the risk of injury to you and others:

- Dynamic Mode- The treadmills have the ability to be used in a free-wheel (non-motorized) mode. This allows the user to manually control the speed of the belt and disengages the belt. Never leave the treadmill in Dynamic Mode, as users unaware of freewheel mode may inadvertently accelerate the belt.
- If the treadmill is stopped while in use at an incline (e.g. emergency stop switch activated, safety lanyard pulled, loss of power, etc.) the belt may freewheel. The user's weight and gravity can lead to inadvertent belt acceleration.
- Always press the STOP button to end the workout.
- Never leave the treadmill unattended while a workout is in progress.
- Set up and operate the treadmill on a solid, level surface.
- Use the treadmill only for its intended purpose as described in the manual. Do not use attachments not specified by the manufacturer.
- The treadmill should never be left unattended when plugged in. Unplug the treadmill from the outlet when not in use and before cleaning or servicing.
- Do not operate the treadmill outside.
- To disconnect the treadmill, turn all controls to OFF position then remove the plug from the outlet.
- Connect the treadmill to a properly grounded outlet only. See Grounding Instructions.
- Keep all loose clothing and towels away from the running surface. It is also important that shoe laces do not extend beyond the bottom of the shoe.
- Keep the area behind treadmill clear and at least 78" (2 m) from walls or furniture.
- Keep hands away from all moving parts.
- Never leave children unsupervised while on or near the treadmill.
- Inspect the treadmill for worn or loose components prior to use. Tighten or replace any worn or loose components prior to use.
- Read, understand, and test all emergency stop procedures.
- Always use the emergency safety pull cord supplied with the treadmill. It can be clipped to an article of clothing while training. This is for the user's safety in case of an emergency.
- WOODWAY treadmills are built to handle runners weighing up to 800 lbs. (360 kg) at speeds between 0-4 MPH (0-6.5 km/h) and 400 lbs. (180 kg) at speeds greater than 4MPH (6.5 km/h).
- The treadmill running belt might not stop immediately if an object becomes caught in the belt or rollers.
- WOODWAY recommends that facilities utilizing high speed/over-speed training applications or special applications, or those that have users who are elderly, are children, or have health limitations, use a safety gantry harness. The manufacturer declines any liability for personal injury and/or property damage which could have been avoided with the use of a gantry harness system.
- Care should be taken when mounting and dismounting the treadmill. Never mount or dismount the treadmill while the running belt is moving. Use the handrails and handlebar whenever practical or necessary.
- Wear proper athletic shoes with rubber or high-traction soles. Do not use shoes with heels or leather soles. Ensure no stones are embedded in the profile of the soles.
- Allow several minutes to bring your heart rate into the training zone depicted in the manual. Walk slowly after your workout to allow your body sufficient time to cool down and your heart rate to decrease.
- The safety and integrity designed for the machine can only be maintained when the treadmill is regularly examined for damage and/or wear and repaired if necessary. It is the sole responsibility of the user/owner or facility operator to ensure that regular maintenance is performed. Worn or damaged components should be replaced immediately or the treadmill should be removed from service until the repair is made. Only manufacturer-supplied or approved components should be used to maintain and repair the treadmill.

SAVE THESE INSTRUCTIONS





1.2 Description of Warning Notices

Warning notices indicate potential hazards or safety risks. They are indicated in this manual by a color-coded signal word panel (symbol with the appropriate signal word). All warning notices have the same design and the same standardized content design.

Sample of a Warning Notice

 SIGNAL WORD
Warning Text, Type, and Source of Danger Description of the consequences of ignoring the danger <ul style="list-style-type: none">▶ Measures, instructions, and forbidden actions to avoid the hazard▶ Further measures

Classification

	NOTE or ATTENTION (no danger symbol) No risk of injury, pertinent information and warning against material damage
	CAUTION (with danger symbol) Slight possibility of injury
	WARNING (with danger symbol) In a dangerous situation, serious accident possible with the possibility of injury or death
	DANGER (with danger symbol) In the event of an accident, immediate danger of death or serious injury

1.3 Safety Notices on Device

The treadmills are equipped with the following listed safety markings. Replace the safety stickers if they become damaged or illegible. Safety-relevant information is identified using the following stickers:

1.3.1 4Front / Pro / Pro XL

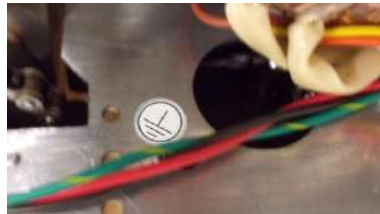

Protective Ground Wire Connection

Motorized treadmills are electric devices in protection class I. Proper ground wire connection must be ensured. This notice is located inside the housing of the treadmill.



Warning EMERGENCY OFF Magnet

If the device is not in use, the EMERGENCY OFF magnet with safety line and clip are to be stored out of the reach of children.



Notice on EMERGENCY OFF Magnet

Information sign on attaching the safety cord to the user, as well as for storing the EMERGENCY STOP magnet with the safety cord and clip out of the reach of children when not in use.



Notice on Display 4Front, Left Side

To prevent injury, stand on the side panels prior to starting the device. Read the operating instructions prior to use. Consult your trainer/therapist prior to use. Stop training immediately if you feel dizzy or exhausted.

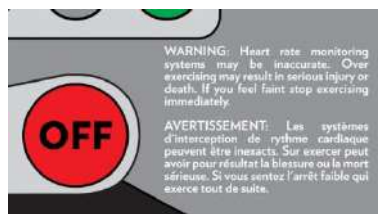

Notice on Display 4Front, Right Side

The heart rate indicator is exact (if used). Overtraining can lead to serious injury or death. Stop training immediately as soon as you feel exhausted.

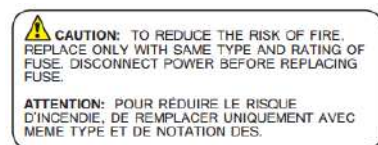

Safety Notice for Fuse Change

To prevent fire hazard, only replace fuses with the same type and power fuses. Remove the device from the mains before changing. This notice is located near the fuse inside the body of the treadmill.



Warning to Not Tension Belt

To prevent incorrectly tensioning running belt and causing damage or injury, call WOODWAY for proper instruction or to set up an appointment with a service technician. This is located just inside the treadmill side covers.



Warning on Power Cord

To reduce the risk of injury from moving parts, unplug the treadmill before servicing. Use time-delay fuses if applicable.

1.3.2 Desmo / ELG

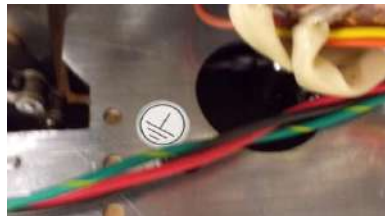

Protective Ground Wire Connection

Motorized treadmills are electric devices in protection class I. Proper ground wire connection must be ensured. This notice is located inside the housing of the treadmill.



Warning EMERGENCY OFF Magnet

If the device is not in use, the EMERGENCY OFF magnet with safety line and clip are to be stored out of the reach of children.



Notice on EMERGENCY OFF Magnet

This is an information sign on mounting the EMERGENCY OFF magnets and for securing the safety line to the user.



Danger Due to Electric Voltage

This symbol warns the user of dangerous voltage inside the device via the safety sticker on the electrical cover. (Desmo)

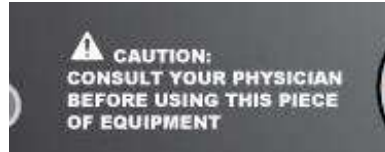

Notice on Display PTB/STD Left Side

Consult your physician or trainer before using the treadmill.



Notice on Display PTB/STD Right Side

Stop training if you do not feel well or are out of breath.

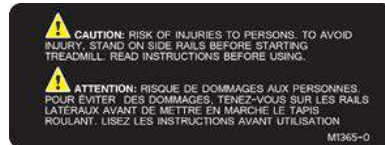

Notice on Bottle Holder

To prevent injury, stand on the side panels prior to starting the device. Read the operating instructions prior to use.



Warning to Not Tension Belt

To prevent incorrectly tensioning running belt and causing damage or injury, call WOODWAY Service for proper instruction or to set up an appointment with a service technician. This is located just inside the treadmill side covers.



Warning on Power Cord

To reduce the risk of injury from moving parts, unplug the treadmill before servicing. Use time-delay fuses if applicable.

1.3.3 Mercury / Path



Protective Ground Wire Connection

Motorized treadmills are electric devices in protection class I. Proper ground wire connection must be ensured. This notice is located inside the housing of the treadmill.



Warning EMERGENCY OFF Magnet

If the device is not in use, the EMERGENCY OFF magnet with safety line and clip are to be stored out of the reach of children.



Notice on EMERGENCY OFF Magnet

This is an information sign on mounting the EMERGENCY OFF magnets and for securing the safety line to the user.

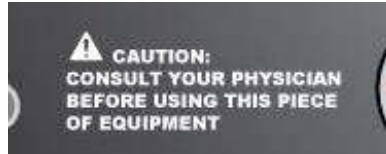

Notice on Display PTB/STD Left Side

Consult your physician or trainer before using the treadmill.



Notice on Display PTB/STD Right Side

Stop training if you do not feel well or are out of breath.



Danger Due to Electric Voltage

This symbol warns the user of dangerous voltage inside the device via the safety sticker on the electrical cover.



Notice on Bottle Holder

To prevent injury, stand on the side panels prior to starting the device. Read the operating instructions prior to use.



Warning to Not Tension Belt

To prevent incorrectly tensioning running belt and causing damage or injury, call WOODWAY Service for proper instruction or to set up an appointment with a service technician. This is located just inside the treadmill side covers.



Warning on Power Cord

To reduce the risk of injury from moving parts, unplug the treadmill before servicing. Use time-delay fuses if applicable.

1.4 Personnel Qualifications and Responsibilities

WARNING

Danger due to Improper Use!

Improper handling of the device can lead to serious personal injury and property damage.

- ▶ The device may only be operated by persons who have received instructions from qualified service personnel.
- ▶ WOODWAY recommends the use of a training record (see Section **Error! Reference source not found.** Page **Error! Bookmark not defined.**) for proof of instruction.

Representative

The representative is the person or company that is responsible for setting up, using, and maintaining the device.

The representative of the treadmill is responsible for the regular maintenance and testing as required by law. They are also obligated to provide adequate training/instruction to the operating personnel. WOODWAY recommends the training be carried out by a trained and authorized WOODWAY dealer or service partner.

Operator

Operators of treadmills for medical applications are persons who use the device and have the "power of control" over the device. This can be a therapist, sports physician, or any other supervisor. The operator of a medical device is any person who - regardless of qualifications - independently uses a medical product in the commercial sector.

The operator is personally responsible for the safety of the user (e.g. patient, test subject, athlete). Due to the high degree of responsibility these persons have a special obligation to provide information on all aspects of safety of the device and its intended use.

1.5 Intended Use

WARNING

Danger from Improper Use!

Any improper use and/or other use of the device can lead to dangerous situations with significant personal injury and/or property damage.

- ▶ Only use the treadmill for its intended use.
- ▶ Avoid excessive training, as this can lead to injury.
- ▶ Read and strictly adhere to all information in the operating instructions.

All listed treadmill types are motorized. They serve to train athletic running training, to increase stamina and physical fitness, and can be used for running or walking. Please note that all treadmills that are listed in this manual are athletic training equipment, which according to EU regulations are not to be used for medical applications.

The operating instructions are an integral part of the treadmill and are to be available to all users at all times. The exact observance of the instructions is a prerequisite for the intended use of the WOODWAY treadmill.

WARNING

Risk of Injury Through Risk of Falling!

The motorized treadmill presents the danger of falling.

- ▶ Familiarize yourself with treadmill operation and operating principles before the first training.
- ▶ Always use the safety handrail when mounting and dismounting and when starting training.

ATTENTION

Claims to the manufacturer of any kind due to damage from improper use are excluded.

The representative alone is liable for all damages resulting from improper use.

1.6 Unauthorized Modes of Operation

The treadmill may only be used for the aforementioned intended use. Any additional uses may result in serious personal injury and/or property damage.

The following restrictions and prohibitions must be strictly adhered to:

- Treadmill may not be used without prior instruction by qualified personnel.
- Children may not use the device or be left near the device unattended.
- Animals and children may not use the device or be left near the device unattended (Exception: see "Application Options for Children" Section **Error! Reference source not found.** Page **Error! Bookmark not defined.**).
- Use of the treadmill under the influence of alcohol, drugs and/or narcotics is prohibited.
- The treadmill is not intended to be used by persons weighing more than 800 lbs. (360 kg) when walking at speeds up to 4 mph, or more than 400 lbs. (180 kg) when running at speeds exceeding 4 mph.
- Transportation of objects on the treadmill is not allowed.
- Walking surface is not suited for the use of running shoes with spikes or studs.
- It is forbidden to use the treadmill without its side rails or with walking poles.
- The operation of WOODWAY slat belt treadmills outside of the named ambient conditions in the section "Setup & Installation" (temperature, humidity, air pressure) as well as outdoors (i.e. outside of closed rooms) is not allowed.
- For people with health limitations or contraindications, the use of a treadmill without prior consultation by a health care professional is prohibited.
- When stepping onto the treadmill, during walking exercises, and when stepping off of the treadmill the safety instructions in this manual must be observed. Here, the following restrictions apply:
 - Never jump onto the moving belt
 - Never jump off while the device is moving
 - Never jump off of the front
 - Never stop walking when the belt is moving
 - Never turn around when the belt is moving
 - Never walk sideways or backwards
 - Never set the stress level (speed) too high

WARNING

Unauthorized Use Can Cause Injury!

Using the treadmill in a manner not authorized by WOODWAY can be potentially hazardous.

- ▶ Only use the device for its intended use as described in the manual.
- ▶ Do not use unauthorized replacement parts or accessories that could interfere with the functionality or safety of the device.
- ▶ Always use the safety handrail when mounting and dismounting and when starting training.
- ▶ If the device is damaged or not functioning properly, do not use until it has been inspected and/or repaired by qualified and authorized personnel.

2 Introduction

2.1 Operating Instructions Information

This manual provides information on the safe operation of the WOODWAY slat belt treadmill.

A condition for safe operation is compliance with all safety and operating instructions.

CAUTION

Improper Operation Can Cause Accidents!

Not using the treadmill as intended according to the manufacturer's instructions can cause accidents and equipment damage.

- ▶ These operating instructions must be completely read and understood before using the treadmill.
- ▶ Keep these instructions close at hand for all users of the device.

Read and Observe the Operating Instructions!



Read these instructions carefully before beginning any work on the treadmill. It is a part of the device and must be kept accessible at all times and in the immediate vicinity of the treadmill for operating and maintenance personnel.

Observe the Instructions

WOODWAY accepts no liability for accidents, equipment damage, and consequences of equipment failure that are a result of failure to follow the operating instructions. In addition, local accident prevention regulations and general safety conditions for intended use of the treadmill apply.

The manufacturer reserves the right to make technical changes in the context of improving the performance properties and further development without prior notice. Illustrations are for basic understanding and may differ from the actual design of the device.

Accessories from other suppliers have further safety regulations and guidelines which must also be observed. WOODWAY accepts no liability for accidents, equipment damage, and personal injury caused by the use of accessories from other suppliers.

2.2 Limitation of Liability

All information and instructions in this manual have been compiled in accordance with applicable standards and regulations, the current state of technology, and our knowledge and experience.

WOODWAY accepts no responsibility for damages resulting from:

- Disregarding the operating instructions
- Improper use
- Use by non-authorized persons
- Use of replacement parts which were not approved by WOODWAY
- Unauthorized modifications to the device or accessories

WOODWAY general terms and conditions and delivery conditions apply, as well as the legal regulations valid at the time of contract conclusion.

2.3 Copyright

The release of the operating instructions to third parties without the written permission of WOODWAY is prohibited.

NOTE

All contents, text, drawings, images, or other illustrations are copyright protected and are subject to intellectual property rights.
Any misuse is punishable by law.

Duplication in any manner and form - including excerpts - as well as use and/or communication of the content are not permitted without written permission from WOODWAY.

2.4 Replacement Parts

WOODWAY recommends the use of original replacement parts. Original replacement parts have particular qualities and ensure reliable and safe operation.

- Developed for specific use with the device
- Manufactured for high quality and excellence
- Ensure the legal warranty period (excluding wear parts) or other reached agreements

NOTE

The use of NON-original replacement parts may change the characteristics of the device and interfere with the safe use!
WOODWAY does not accept liability for damages resulting from this.

Disposal Wear parts are considered hazardous waste!
After being replaced, wear parts must be disposed of according to country-specific waste laws.
For further information on disposal, see Section 13 Page 133.

2.5 Customer Service

For service questions contact the following:

WOODWAY USA, Inc.

W229 N591 Foster Ct.
Waukesha, WI 53186
USA

Contact Tel: 1 262-548-6235
Fax: 1 262-522-6235
E-Mail: service@WOODWAY.com
Web: www.WOODWAY.com

For faster processing of your request please have the following data and information available:

- Information on the name plate (specific model/serial number)
- An accurate description of the circumstances
- Customer number (if available)
- What action has already been taken

Servicing The address of your local service center can be obtained from the manufacturer. After repair or re-installation, the actions listed under "Setup & Installation" (see Section 5.4.1 Page 37) are to be performed as during installation.

DANGER

Danger of Death by Electric Shock!

Maintenance and inspection work on the unit may cause serious or fatal electrical shock.

- ▶ Pull the power plug prior to any maintenance and inspection work on the equipment. The device must not be connected to the power!
- ▶ Ensure the device cannot be switched back on.

2.6 EC Declaration of Conformity





EG-Konformitätserklärung EC Declaration of Conformity

Hiermit erklärt der / Hereby we declare

Hersteller: **WOODWAY USA Inc.**
 Manufacturer:

Adresse: W229 N591 Foster Court
 Address: Waukesha, Wisconsin 53186, USA
 Phone: +1 262 548 6235
 E-Mail: info@woodway.com
 Web: http://www.woodway.com

in eigener Verantwortung die Übereinstimmung der nachfolgend aufgeführten Produkte in der gelieferten Ausführung mit den grundlegenden Anforderungen der folgenden EG-Richtlinien, wie im Amtsblatt der Europäischen Union veröffentlicht:
in sole responsibility that the product in the form as delivered and described below is in conformity with the provisions and essential requirements of the following European Directives, as published in the Official Journal of the European Union:

- Richtlinie 2006/95/EG (Niederspannungsrichtlinie)
Directive 2006/95/EC (Low Voltage Directive)
- Richtlinie 2004/108/EG (Elektromagnetische Verträglichkeit)
Directive 2004/108/EC (Electromagnetic Compatibility)
- Richtlinie 2006/42/EG (Maschinenrichtlinie)
Directive 2006/42/EC (Machinery)

Produktbezeichnung: **Laufbandergometer für Trainingszwecke**
 Product type: *Treadmill-Ergometer for Training*

Produktname: **Desmo, Desmo H, Desmo HP, Mercury, Mercury H, Path, Path H, Pro, Pro XL, 4 Front**
 Product families: (Modelle ab Oktober 2012 / models from October 2012 onwards)

Die oben beschriebenen Produkte sind konform mit den folgenden anwendbaren, im Amtsblatt der Europäischen Union veröffentlichten, harmonisierten Normen:
Conformity to the Directives for the product described above is assured through the application of the following harmonized standards as published in the Official Journal of the European Union:

- EN 957-1:2005, EN 957-6:2001 Classes: A, S, I
- EN 60335-1:2002/A14:2010
- EN 55014-1:2006/A1:2009, EN 55014-2:1997/A2:2008
- EN 61000-6-1:2007 Immunity, Class B
- EN 61000-6-3:2007 Emission, Class B
- EN ISO 12100:2010

Die Gültigkeit endet mit der Veröffentlichung einer Konformitätserklärung neueren Datums.
The validity ends with the publication of a Declaration of Conformity of a newer date.

Zur Zusammenstellung der technischen Unterlagen (nur für autorisierte EU-Behörden) im Sinne von Artikel 5 der Richtlinie 2006/42/EG ist folgende Person/Firma ermächtigt:
Person/Company authorized to compile the technical file according Article 5 of the Directive 2006/42/EC (on the demand of competent EU authorities only):

WOODWAY GmbH, Steinackerstr. 20, 79576 Weil am Rhein, Germany
 e-mail: safety "at" woodway.de, phone: +49 (0)7621 940 999 28

Waukesha, USA
 25. March 2013
 March 23rd 2013



Douglas Bayerlein
 Präsident / President WOODWAY USA, Inc.

Fig. 1 EC Declaration of Conformity

3 Technical Data

3.1 Turning the Treadmill ON/OFF

- The main power switch with the universal power symbol (⏻) is located at the base of the treadmill near the treadmill's power cord.
- "I" position: Treadmill is turned on and the belt is held tight. Turn the display on to operate the treadmill.
- "O" position: Treadmill is turned off and the belt is free moving.

3.2 Name Plate

Each WOODWAY treadmill receives a serial number during production. Depending on the year of your model, it has an alphanumeric code with 7-8 characters or a numeric code with 9 digits. The serial number can be found on the name plate, which is mounted on the rear of the display or on the left front of the treadmill frame.

The name plate contains the device's main technical details.

The treadmill range of functions is stated on the name plate and on the delivery note.

Keep Handy for Questions

For service questions, the technical information on the name plate must be kept handy.

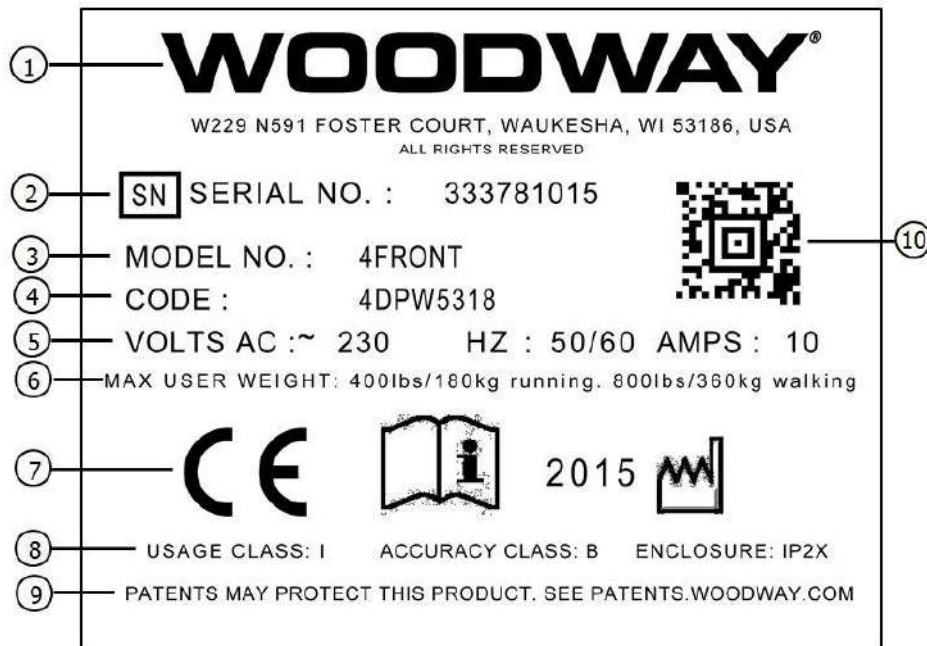

Fig. 2 Name plate

- | | |
|--|---|
| <ol style="list-style-type: none"> 1. Manufacturer name, address, and logo 2. Serial no. 3. Model no. 4. Product code 5. Information on electrical connection 6. Max. user weight load | <ol style="list-style-type: none"> 7. Device CE symbol (with number of the named position), note to read and observe operating instructions, and year manufactured 8. Usage class, accuracy class, and enclosure rating 9. Patent protection note 10. 2D universal identification number code |
|--|---|

3.3 Technical Specifications

3.3.1 4Front



Figure: 4Front with TV

4Front

- Running Surface: 22" W x 68" L (55 x 173 cm)
60 slats (replaceable), rubber on aluminum T-sections
Approx. 40 Shore A -- +/- 4 mm lateral tolerance
- Drive System: 114 ball bearings, 12 guide rollers
- Overall Dimensions:
35" W x 72" L x 64" H (89 x 183 x 163 cm)
- Weight: 445 lbs. (201 kg)
- Speed: 0-12.5 mph (0-20 km/h)
- Incline: 0-15%
- C Board displays the parameters speed, incline, distance, time, heart rate, calories burned, pace, and METs
- Power Supply: 115 VAC 20 Amp (NEMA 5-20R outlet, 20 Amp dedicated circuit required)

Options:

- Higher Speeds: up to 18 mph (29 km/h)
- Reverse: 0-5 mph (0-8 km/h)
- Steeper Incline: up to 25%
- Incline: (-3%)-(+22%)
- LCD Personal Trainer Display Board
- Power Supply Upgrade: 208/230 VAC 20 Amp
- Interface RS232 incl. Control Software
- Special Paint Finish

4Front with TV or Entertainment

- Running Surface: 22" W x 68" L (55 x 173 cm)
60 slats (replaceable), rubber on aluminum T-sections
Approx. 40 Shore A -- +/- 4 mm lateral tolerance
- Drive System: 114 ball bearings, 12 guide rollers
- Overall Dimensions:
35" W x 72" L x 64" H (89 x 183 x 163 cm)
- Weight: 445 lbs. (201 kg)
- Speed: 0-12.5 mph (0-20 km/h)
- Incline: 0-15%
- LED Standard Display Board displays the parameters speed, incline, distance, time, heart rate, calories burned, pace, and METs

Options:

- Higher Speeds: up to 18 mph (29 km/h)
- Reverse: 0-5 mph (0-8 km/h)
- Steeper Incline: up to 25%
- Incline: (-3%)-(+22%)
- LCD Personal Trainer Display Board
- Interface RS232 incl. Control Software
- Special Paint Finish

Additional options may be available.
Please contact your sales representative.

3.3.2 Desmo / Desmo H / Desmo HP



Figure: Desmo

Additional options may be available.
Please contact your sales representative.

Desmo

- Running Surface: 22" W x 68" L (55 x 173 cm)
60 slats (replaceable), rubber on aluminum T-sections
Approx. 40 Shore A -- +/- 4 mm lateral tolerance
- Drive System: 114 ball bearings, 12 guide rollers
- Overall Dimensions:
38" W x 77" L x 63" H (97 x 196 x 160 cm)
- Weight: 445 lbs. (201 kg)
- Speed: 0-12.5 MPH (0-20 km/h) (0-15 MPH standard on HP)
- Incline: 0-15%
- LED Standard Display Board displays the parameters speed, incline, distance, time, heart rate, calories burned, pace, and METs
- Power Supply: 115 VAC 20 Amp (NEMA 5-20R outlet, 20 Amp dedicated circuit required)

Options:

- Higher Speeds: up to 18 mph (29 km/h)
- Reverse: 0-5 mph (0-8 km/h)
- Steeper Incline: up to 25%
- Incline: (-3%)-(+22%)
- LCD Personal Trainer Display Board (standard on Desmo H)
- Power Supply Upgrade: 208/230 VAC 20 Amp
- Interface RS232 incl. Control Software
- Special Paint Finish
- Alternate Handrail Options
- Jump Plate

3.3.3 ELG



Figure: ELG

Additional options may be available.
Please contact your sales representative.

ELG

- Running Surface: 27" W x 96" L (70 x 244 cm)
87 slats (replaceable), rubber on aluminum T-sections
Approx. 40 Shore A -- +/- 4 mm lateral tolerance
- Drive System: 158 ball bearings, 16 guide rollers
- Overall Dimensions:
48" W x 102" L x 79" H (122 x 259 x 201 cm)
- Weight: 1634 lbs. (740 kg)
- Speed: 0-25 MPH (0-40 km/h)
- Incline: (-5%)-(+35%)
- LED Standard Display Board displays the parameters speed, incline, distance, time, heart rate, calories burned, pace, and METs
- Power Supply: 208/230 VAC 30 Amp (L6-30R outlet, 30 Amp dedicated circuit required)

Options:

- Reverse: 0-5 mph (0-8 km/h)
- LCD Personal Trainer Board
- Interface RS232 incl. Control Software
- Special Paint Finish
- Single Handrail
- Gantry Suspension System

3.3.4 Mercury



Figure: Mercury

Additional options may be available.
Please contact your sales representative.

Mercury

- Running Surface: 17" W x 68" L (43 x 173 cm)
60 slats (replaceable), rubber on aluminum T-sections
Approx. 40 Shore A -- +/- 4 mm lateral tolerance
- Drive System: 114 ball bearings, 12 guide rollers
- Overall Dimensions:
34" W x 71" L x 60" H (86 x 180 x 152 cm)
- Weight: 405 lbs. (184 kg)
- Speed: 0-11 mph (0-18 km/h)
- Incline: 0-15%
- LED Standard Display Board displays the parameters speed, incline, distance, time, heart rate, calories burned, pace, and METs
- Power Supply: 115 VAC 20 Amp (NEMA 5-20R outlet, 20 Amp dedicated circuit required)

Options:

- Higher Speeds: up to 16.5 mph (26 km/h)
- Reverse: 0-5 mph (0-8 km/h)
- Steeper Incline: up to 25%
- Incline: (-3%)-(+22%)
- LCD Personal Trainer Display Board
- Power Supply Upgrade: 208/230 VAC 20 Amp
- Interface RS232 incl. Control Software
- Special Paint Finish

3.3.5 Path



Figure: Path

Additional options may be available.
Please contact your sales representative.

Path

- Running Surface: 22" W x 52" L (55 x 132 cm)
47 slats (replaceable), rubber on aluminum T-sections
Approx. 40 Shore A -- +/- 4 mm lateral tolerance
- Drive System: 80 ball bearings, 8 guide rollers
- Overall Dimensions:
38" W x 59" L x 60" H (97 x 150 x 152 cm)
- Weight: 370 lbs. (168 kg)
- Speed: 0-11 mph (0-18 km/h)
- Incline: 0-15%
- LED Standard Display Board displays the parameters speed, incline, distance, time, heart rate, calories burned, pace, and METs
- Power Supply: 115 VAC 20 Amp (NEMA 5-20R outlet, 20 Amp dedicated circuit required)

Options:

- Higher Speeds: up to 15 mph (24 km/h)
- Reverse: 0-5 mph (0-8 km/h)
- LCD Personal Trainer Display Board
- Power Supply Upgrade: 208/230 VAC 20 Amp
- Interface RS232 incl. Control software
- Special Paint Finish

3.3.6 Pro



Figure: Pro

Pro

- Running Surface: 27" W x 68" L (70 x 173 cm)
60 slats (replaceable), rubber on aluminum T-sections
Approx. 40 Shore A -- +/- 4 mm lateral tolerance
- Drive System: 114 ball bearings, 12 guide rollers
- Overall Dimensions:
48" W x 76" L x 68" H (122 x 193 x 173 cm)
- Weight: 575 lbs. (261 kg)
- Speed: 0-15 MPH (0-24 km/h)
- Incline: 0-25%
- LED Standard Display Board displays the parameters speed, incline, distance, time, heart rate, calories burned, pace, and METs
- Power Supply: 208/230 VAC 20 Amp (NEMA 6-20R outlet, 20 Amp dedicated circuit required)

Options:

- Higher Speeds: up to 16.5 mph (26 km/h)
- Reverse: 0-5 mph (0-8 km/h)
- Incline: (-3%)-(+22%)
- LCD Personal Trainer Board
- Interface RS232 incl. Control Software
- Special Paint Finish
- Jump Plate

Pro with TV or Entertainment

- Running Surface: 27" W x 68" L (70 x 173 cm)
60 slats (replaceable), rubber on aluminum T-sections
Approx. 40 Shore A -- +/- 4 mm lateral tolerance
- Drive System: 114 ball bearings, 12 guide rollers
- Overall Dimensions:
48" W x 80" L x 78" H (122 x 203 x 198 cm)
- Weight: 575 lbs. (261 kg)
- Speed: 0-15 mph (0-24 km/h)
- Incline: 0-25%
- LED Standard Display Board displays the parameters speed, incline, distance, time, heart rate, calories burned, pace, and METs

Options:

- Higher Speeds: up to 16.5 mph (26 km/h)
- Reverse: 0-5 mph (0-8 km/h)
- Incline: (-3%)-(+22%)
- LCD Personal Trainer Board
- Interface RS232 incl. Control Software
- Special Paint Finish

Additional options may be available.
Please contact your sales representative.

3.3.7 Pro XL

Figure: Pro XL

Pro XL

- Running Surface: 27" W x 88" L (70 x 224 cm)
77 slats (replaceable), rubber on aluminum T-sections
Approx. 40 Shore A -- +/- 4 mm lateral tolerance
- Drive System: 160 ball bearings, 18 guide rollers
- Overall Dimensions:
48" W x 94" L x 70" H (122 x 239 x 178 cm)
- Weight: 675 lbs. (307 kg)
- Speed: 0-15 MPH (0-24 km/h)
- Incline: 0-25%
- LED Standard Display Board displays the parameters speed, incline, distance, time, heart rate, calories burned, pace, and METs
- Power Supply: 208/230 VAC 20 Amp (NEMA 6-20R outlet, 20 Amp dedicated circuit required)

Options:

- Higher Speeds: up to 16.5 mph (26 km/h)
- Reverse: 0-5 mph (0-8 km/h)
- Incline: (-3%)-(+22%)
- LCD Personal Trainer Board
- Interface RS232 incl. Control Software
- Dual Handrail
- Special Paint Finish
- Jump Plate

Pro with TV or Entertainment

- Running Surface: 27" W x 88" L (70 x 224 cm)
77 slats (replaceable), rubber on aluminum T-sections
Approx. 40 Shore A -- +/- 4 mm lateral tolerance
- Drive System: 160 ball bearings, 18 guide rollers
- Overall Dimensions:
48" W x 98" L x 80" H (122 x 249 x 203 cm)
- Weight: 675 lbs. (307 kg)
- Speed: 0-15 mph (0-24 km/h)
- Incline: 0-25%
- LED Standard Display Board displays the parameters speed, incline, distance, time, heart rate, calories burned, pace, and METs

Options:

- Higher Speeds: up to 16.5 mph (26 km/h)
- Reverse: 0-5 mph (0-8 km/h)
- Incline: (-3%)-(+22%)
- LCD Personal Trainer Board
- Interface RS232 incl. Control Software
- Special Paint Finish

Additional options may be available.
Please contact your sales representative.

3.4 Dimensions

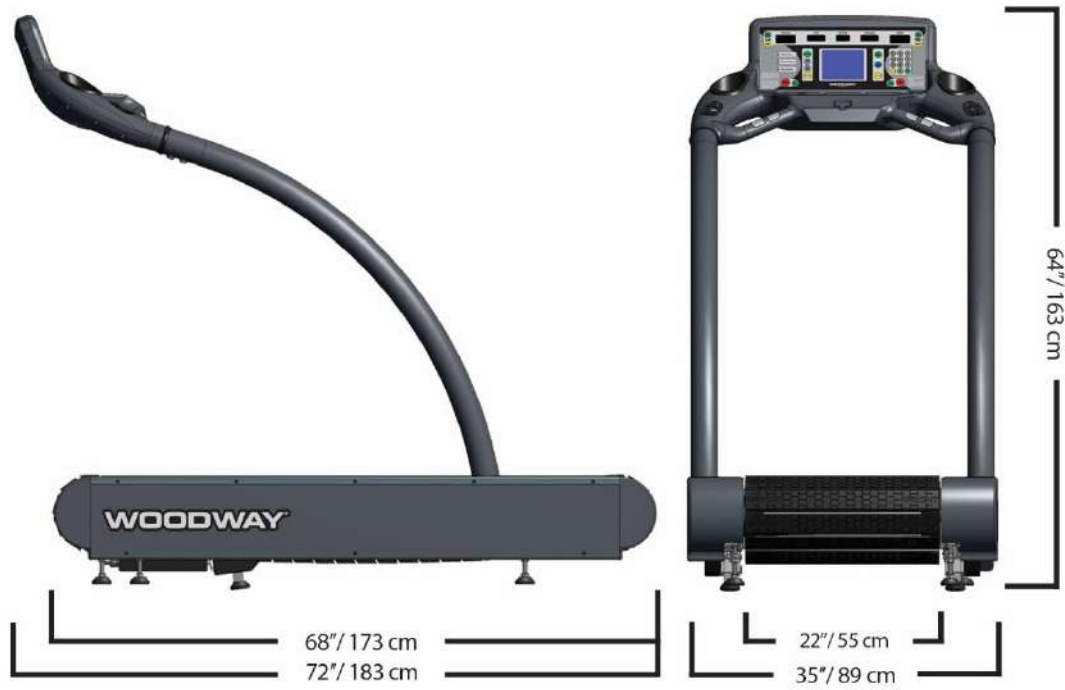

Fig. 3 4Front dimensions

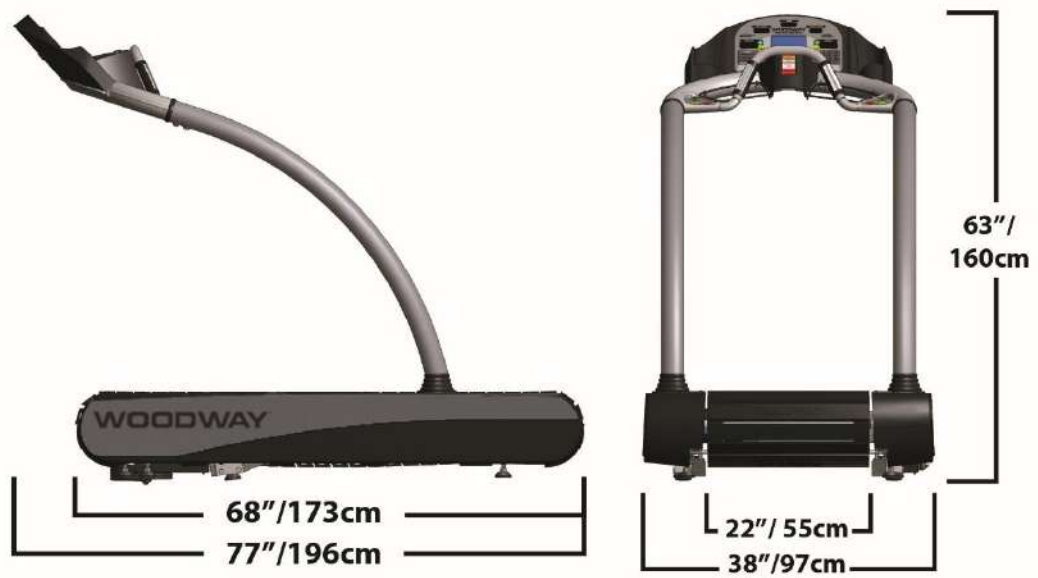

Fig. 4 Desmo dimensions

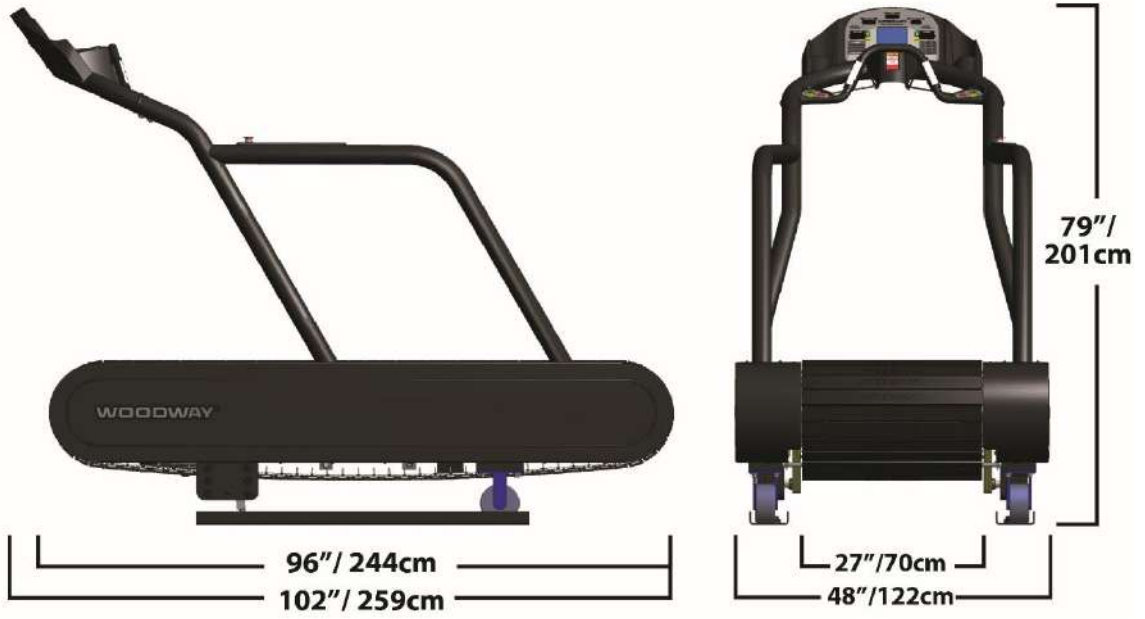

Fig. 5 ELG dimensions

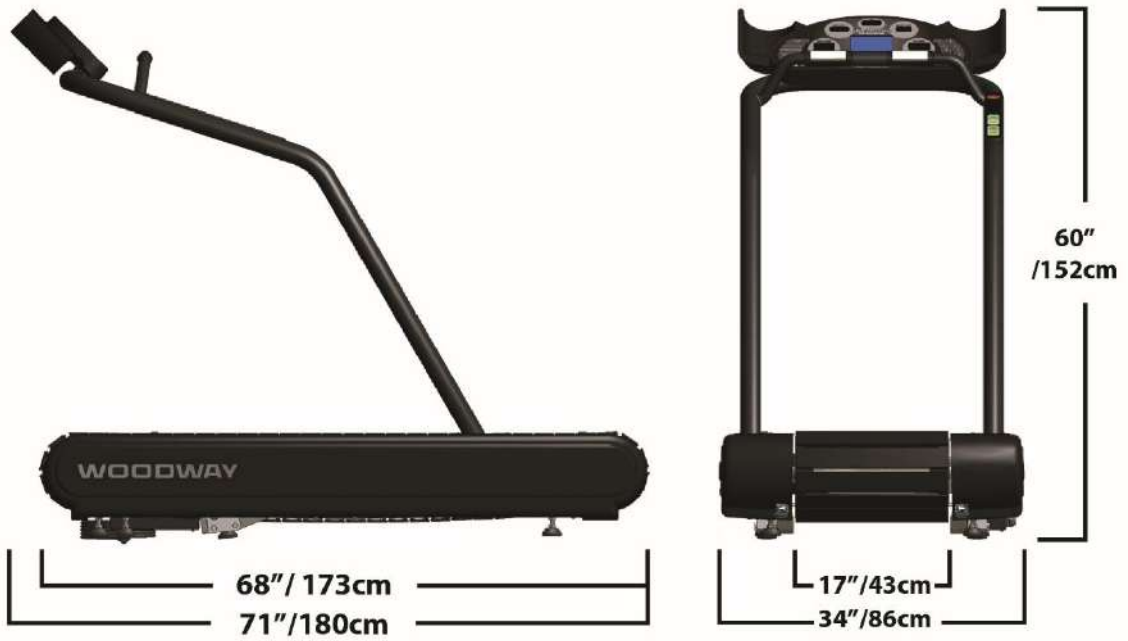

Fig. 6 Mercury dimensions



Fig. 7 Path dimensions

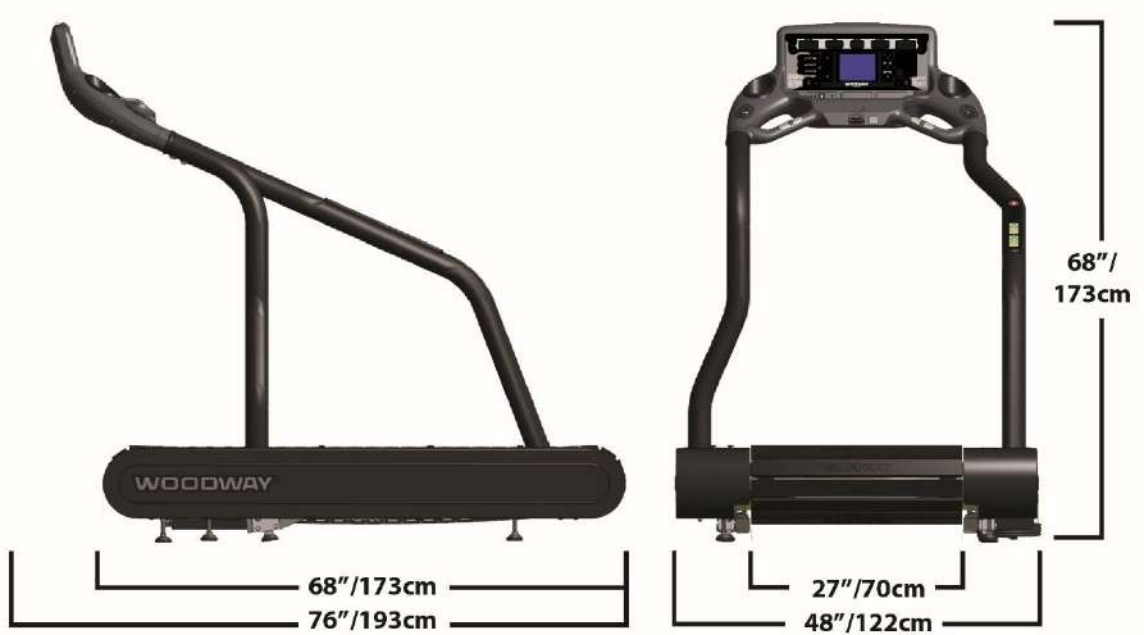

Fig. 8 Pro dimensions

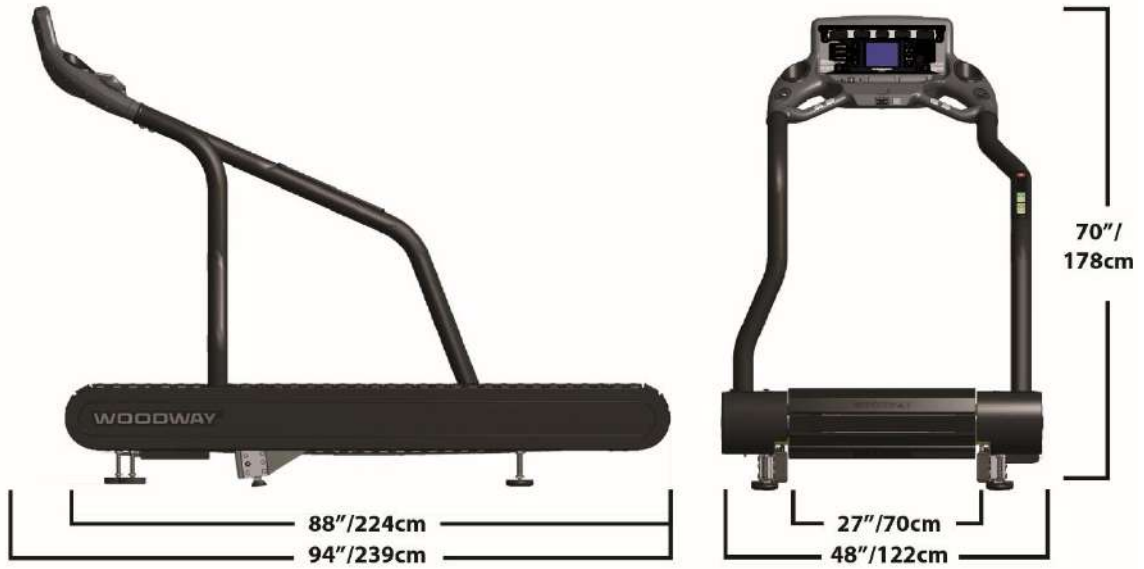

Fig. 9 Pro XL dimensions

3.5 Conditions for Use

Description	Parameters
Ambient Temperature	50°F to 104°F (10°C to 40°C)
Relative Humidity	20-95% (not condensed)
Enclosure Rating	IP2x

3.6 Electrical Connection

IMPORTANT- The power cord must be properly protected at all times, both when in use and storage.

Below are the standard electrical requirements by region. There are different options depending on which model you own. If you have a different electrical configuration, please contact your sales representative.

DO NOT BEND OR REMOVE PRONGS. The plugs are polarized, meaning the prongs are different sizes and the plug can only fit in the outlet one way; if the plug does not fit, reverse the plug. If other power cord plugs are required, please contact WOODWAY.

Before connecting the treadmill to the power supply, the information on main voltage and frequency (found on the name plate) is to be compared with the on-site connection values. Only connect the device if the values match. Power surges or voltage drops can cause malfunctions or defects in the device.

No other treadmills or devices may be operated on the same supply line. Each treadmill must be operated with its own circuit breaker. The treadmill must be grounded.

DANGER

Danger of Death by Electric Shock!

Improper handling of electrical equipment by unqualified persons can cause fatal electrical shock.

- ▶ If necessary, allow only qualified personnel to perform electrical installation.
- ▶ The power cord must not come into contact with hot surfaces or sharp edges.
- ▶ Electrical parts (eg. motor, power cord, and power switch) must not come in contact with water.

WARNING

Danger of Injury by Falling when Switching the Device Off!

A complete shutdown of the unit caused by power surges or voltage dips can cause abrupt deceleration of the running surface belt.



- ▶ In order to avoid malfunctions, all data on the name plate must correspond with the actual terminal values.

WARNING

Danger of Injury by Tripping Over Wires!

1. Improperly installed wires present a tripping hazard and danger of injury. Safely lay power cords, interface cable, etc. outside of walking areas.

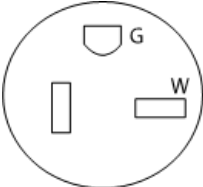
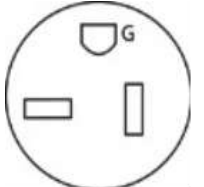
3.6.1 North America

Description	Parameters		
	115 VAC	208/230 VAC	208/230 VAC
Voltage	Requires at least 115 V from wall outlet. If voltage falls 10% below 115 V, treadmill will shut off and reset.	Requires at least 208/230 V from wall outlet. If voltage falls 10% below 208/230 V, treadmill will shut off and reset.	Requires at least 208/230 V from wall outlet. If voltage falls 10% below 208/230 V, treadmill will shut off and reset.
Frequency	50/60 Hz	50/60 Hz	50/60 Hz
Current	20 Amp <i>Dedicated line required (cannot share neutral line)</i>	20 Amp <i>Dedicated line required (cannot share neutral line)</i>	30 Amp <i>Dedicated line required (cannot share neutral line)</i>
Wall Outlet Requirements	 <p>NEMA 5-20 R <i>(dedicated circuit required)</i></p>	 <p>NEMA 6-20 R <i>(dedicated circuit required)</i></p>	 <p>NEMA L6-30 <i>(twist lock, 208-230 VAC, 30 Amp dedicated circuit required)</i></p> 
Outlet Compatibility	Standard 3-prong, hospital grade plug (NEMA 5-20 P) Will only fit a NEMA 5-20 R outlet	3-prong plug (NEMA 6-20 P) Will only fit a NEMA 6-20 R outlet	3-prong twist plug (NEMA L6-30 P) Will only fit a NEMA L6-30 R outlet
Hospital-Grade Low Leakage	For grounding reliability, only connect to proper receptacle marked "Hospital Grade" when using for medical use.		

3.6.1 Germany

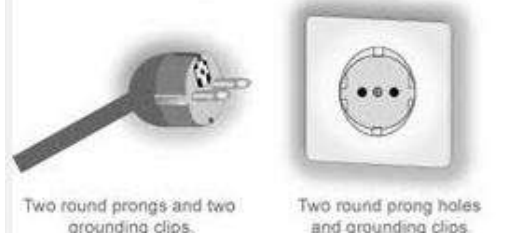
Description	Parameters
	230 VAC
Voltage	Requires at least 230 V from wall outlet. If voltage falls 10% below 230 V, treadmill will shut off and reset.
Frequency	50 Hz
Current	16 Amp <i>Dedicated line required (cannot share neutral line)</i>
Wall Outlet Requirements	<p>Type F Germany, Austria, the Netherlands, Sweden, Norway, Finland, Portugal, Spain and Eastern Europe</p>  <p>Two round prongs and two grounding clips. Two round prong holes and grounding clips.</p>
Outlet Compatibility	F / "Schuko" plug

3.6.2 United Kingdom

Description	Parameters
	230 VAC
Voltage	Requires at least 230 V from wall outlet. If voltage falls 10% below 230 V, treadmill will shut off and reset.
Frequency	50 Hz
Current	13 Amp <i>Dedicated line required (cannot share neutral line)</i>
Wall Outlet Requirements	
Outlet Compatibility	G/BS 1363 plug

4 Transportation and Storage

4.1 Safety Notices for Transportation

Check the treadmill for damage upon arrival. Also check and compare supplied accessories with the corresponding delivery note.

The manufacturer is not liable for damages and missing parts if this information was not recorded in writing on the delivery note upon delivery of the unit. Damage or defects must be reported to the carrier and to the responsible WOODWAY dealer immediately.

! WARNING

Risk of Injury by Machine Falling or Falling Over!

Improper transportation of the device may lead to it falling over and causing injury or equipment damage.

- ▶ Only transport in compliance with the safety regulations.
- ▶ Only use the supplied carrying tubes for transport.
- ▶ Never lift the device using the railing or protective coverings.
- ▶ Ensure stable center of gravity and steadiness during transportation.

WOODWAY Service If necessary, transport or relocation can be organized and carried out by authorized WOODWAY service partners.

For further information please contact WOODWAY Customer Service.

4.2 Flat Transportation

The treadmill can be easily transported on a flat surface using four flat transport dollies (commercial transport dollies with 4 steerable wheels). The device weight must be considered.

It is important to ensure that the device frame near the treadmill feet rests on the dollies. Otherwise, there is a risk of damage to the walking surface or the incline system.

4.3 Upright Transportation

For narrow transport routes it is possible to transport the treadmill vertically (e.g. narrow door width or for climbing stairs). For this, handrails and side panels must be removed.

When transporting in an upright position, the device must be additionally secured against accidental tipping or rolling since the center of gravity is not in the middle of the device.

ATTENTION

The treadmill must not rest on the side on which the power cord is connected!

4.4 Transportation with Carrying Poles

Four carrying poles (square steel pipes) are included as treadmill accessories. The carrying poles can be inserted into the front and back openings in the treadmill frame (Fig. 10 and Fig. 11). The side panels and railings can be removed to facilitate transport.



Fig. 10 Carrying poles

The treadmill may only be lifted at the indicated points.



Fig. 11 Ports to insert carrying poles

4.5 Storage

The device may only be stored in closed, dry rooms. It is absolutely necessary to prevent contact with moisture (rain, fog, etc.)

The following environmental conditions are prescribed for transportation and storage:

- Temperature: 0°F to 120°F (-18°C to +49°C)
- Relative humidity: 20-95% (not condensed)
- Air pressure: 700–1060 hPa

5 Product Description

WARNING

Risk of Injury Through Falling!

During training, especially during the initial use of the device there is a danger of injury from falling.

- ▶ Familiarize yourself with treadmill operation before training.
- ▶ Hold on to the safety railing during the first training program until you can move safely on the treadmill.

5.1 Running Surface

The running surface belt consists of individual slats which are mounted on a set of wedged-toothed belts.

The individual slats consist of two components. The base is a solid aluminum profile and the tread is comprised of a high-traction rubber compound. The combination makes it "the softest treadmill in the world". The approx. 1/2" (1.2 cm) thick rubber surface significantly reduces the impact energy, thus making WOODWAY treadmills much easier on the joints than conventional treadmills.

The WOODWAY running surface differs fundamentally from running belts on conventional treadmills (for which cotton-nylon belts are normally used). On your WOODWAY treadmill you may initially notice higher surface grip than you have experienced before. The more you use your treadmill, the more you will grow accustomed to the grip. As with all treadmills, it is also important on a WOODWAY treadmill not to shuffle your feet if possible.

5.2 Transport System

The support system consists of 2 supporting/secondary rails, which are equipped with high-performance bearings. V-belt guides (6) on each rail ensure lateral stability. The rollers transfer the load to and from the motor and prevent the running belt from slipping through.

The system supports the running surface and distributes the load evenly over the entire treadmill. The running surface belt (slats and steel-wire reinforced, toothed V-belt) is guided by form-fitted drive pulleys on the front and back. The device can even be used without external drive, simply by pushing the treadmill to start the belt moving. The combination of running surface, secondary bearing rails, and drive pulleys gives this slat system unique characteristics:

- Low friction (energy saving)
- Low wear (approx. 150,000 mile [240,000 km] functional service life)
- 100% power transfer through the form-fitted, toothed V-belt system
- High service life (one running surface belt for one treadmill life)

5.3 Incline System

WOODWAY treadmills are equipped with a standard elevation system which is model specific. The elevation system is driven by a geared motor and a chain drive system which is used to transmit forces to several drive sprockets. This gear drive raises or lowers the treadmill on toothed racks. The toothed racks are equipped with rubber feet and bear most of the weight of the treadmill and the person when the incline is used.

Limit switches are used to limit the lifting system. When the display is switched on, the running surface is automatically moved to the 0 incline position (starting position).

WARNING

Danger of Device Moving Down when Switched on!

If the treadmill was in the inclined position prior to being switched off during previous use, the device will automatically move back to the neutral position (0% incline). There is a danger of injury!

- ▶ No one may be located in the area in front of the treadmill.
- ▶ No objects may be located under the treadmill.
- ▶ Check the position of the treadmill before switching it on.

5.4 Dynamic Mode

WARNING

Do Not Leave Treadmill Unattended While in Dynamic Mode!

If the treadmill is left unattended while in dynamic mode, there is a possibility of personal injury from people stepping onto device while assuming the running surface is locked.

- ▶ Never leave the treadmill unattended while in dynamic mode.
- ▶ The running surface runs completely free in both directions and is no longer slowed by the motor.
- ▶ Always keep children and animals clear of the treadmill while in dynamic mode.

The treadmill makes it possible that the user serves as the running surface belt drive. The user drives the running surface belt manually during training. This is known as "dynamic mode"

5.4.1 Dynamic Mode: LED Standard Display Board

To enter dynamic mode, proceed as follows:

1. Reduce both SPEED and INCLINE to zero and step onto side rails.
2. Press and hold the FAST and SLOW keys simultaneously for about 5 seconds.
3. The display emits a signal tone every second.
4. Afterwards, 2 tones will sound and the speed indicator display will start blinking.

Now the treadmill is set to dynamic mode. The running surface belt is now manually driven and the speed is still indicated. The incline also functions.

To leave dynamic mode, proceed as follows.

1. Reduce INCLINE to zero and step onto side rails.
2. Press and hold the FAST and SLOW keys simultaneously for about 5 seconds.
3. The display emits a signal tone every second.
4. Afterwards, 2 tones will sound and the speed indicator display will stop blinking.

Dynamic mode is now deactivated. The running surface belt is now motor driven.

Alternatively, the treadmill can be switched off by pressing the OFF key. When the device is switched back on it will automatically be in normal operating mode and dynamic mode will be deactivated.

5.4.2 Dynamic Mode: LCD Personal Trainer Display Board

To enter dynamic mode, proceed as follows:

1. Reduce both SPEED and INCLINE to zero and step onto side rails.
2. Press and hold the FAST and SLOW keys simultaneously.
3. The display emits 3 tones. Continue holding the FAST and SLOW keys for 5 seconds.
4. Afterwards, one longer tone will sound.
5. The center LCD display shows "Dynamic Mode"

Now the treadmill is set to dynamic mode. The running surface belt is now manually driven and the speed is still indicated. The incline also functions.

To leave dynamic mode, proceed as follows.

1. Reduce INCLINE to zero and step onto side rails.
2. Press the FAST key once to exit dynamic mode.

Dynamic mode is now deactivated.

Alternatively, the treadmill can be switched off by pressing the OFF key. When the device is switched back on it will automatically be in normal operating mode and dynamic mode will be deactivated.

5.5 Power Console

The main power switch, the fuses, and the terminals for optional controls (manual keyboard and display) are located on the power console.

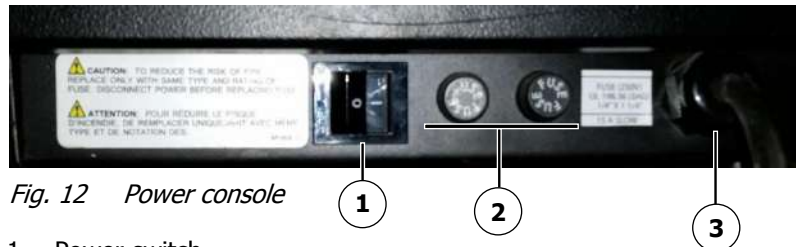

Fig. 12 Power console

1. Power switch
2. 2 x fuses (to change, see Section 9.6 Page 127)
3. Power cord

5.6 Safety Equipment

The WOODWAY treadmills are equipped with different safety equipment depending on model and design. When needed, they serve to prevent dangerous situations and reduce the risk of injury to a minimum. The following safety equipment is available:

- Emergency stop pull-cord with magnetic switch on the display
- PAUSE and STOP buttons on display (and handrail on some models)
- Non-slip coating on side panels (allows emergency dismount by straddling)

WARNING

Dangerous Situations During Operation Can Cause Injury!

Conditions during use of the device that do not correspond to the normal function and require an immediate stop can cause injury. Each actuation of the emergency stop switch causes a power disconnection to the drive system which in turn causes the running surface to emergency stop, which presents an additional risk of falling.

- ▶ Immediate emergency stopping of the device/drive
- ▶ Switching off the device (power button) and pulling the power cord from the socket
- ▶ Clarification and elimination of causes of dangerous situations only by the WOODWAY Customer Service
- ▶ Only restart the device after approval by WOODWAY Customer Service

Emergency Stop Pull-Cord

The emergency stop switch is a magnetic contact switch, which is attached in the running direction on the display head. The circuit is closed through a magnet. As soon as the magnet tears off the contact-free surface, an interruption of the power supply will initiate an emergency stop.

The magnet is secured to the runner's clothing by a clip on a lanyard/pull-cord. It should be fixed to a tight piece of clothing (e.g. waistband).

The safety magnet can also be used to immobilize the treadmill and prevent a third party from using the device. To prevent the use of the treadmill, for example when not supervised, the safety magnet with pull-cord can be stored in a safe place and the treadmill cannot be put into operation.

The pull-cord is not fall protection and cannot prevent a person from falling on the treadmill. It only serves as an emergency stop in dangerous situations. When the magnet is released, the drive system is disconnected from the power and an emergency stop is initiated.

There is an increased risk of falling (e.g. during performance diagnostics, intense sprinting, and long runs). There is an increased risk of injury from falling, especially in rehabilitation where patients with various physical limitations use the treadmill.

WARNING

Danger of Injury due to Improperly Installed Pull-Cord!

If the pull-cord is not installed properly before a workout, the emergency stop magnetic switch will not be triggered and there is a risk of injury in the event of a dangerous situation.

- ▶ The use of the pull-cord is mandatory.
- ▶ Securely attach clip to tight clothing before starting the workout.
- ▶ Adjust the length of the pull-cord with rope stopper to the shortest possible setting, while ensuring that movement is still unrestricted.

Safety Railing The treadmill is equipped with a railing that extends along both sides. This allows the user to maintain direct contact, so as to obtain safety and stability during training.
For safety reasons, the user should hold on to the railing when necessary (e.g. for stopping).

 **CAUTION**

Risk of Injury Through Risk of Falling!

It is recommended to use the railing for mounting and dismounting!

Belt Drive Current Limiting

The WOODWAY medical treadmills are equipped with a current limit control function which reduces power consumption and increases safety. The main safety feature is the current limiter after time overflow.

If the running belt is blocked for more than 10 seconds, the motor current will be reduced to 6A. This is always recommended in case something gets caught in the belt, as it stops the belt automatically. Once the current limit control has been triggered, the motor torque is reduced to a minimum to prevent damage to the motor and electric system.

Low Leakage Current

The requirement for low leakage current is important for medical clinics, physical therapy facilities, and hospitals.

The treadmill functions are designed so that the power plug and input power transformer are subjected to low leakage current. With an input power transformer with low leakage current, the leakage treadmill current can be reduced to less than 200 micro-amps (uA).

** Not applicable to ELG*

Dismounting in Emergency Situations

WOODWAY treadmills have a slip-resistant surface alongside the running surface. This offers additional grip when dismounting and prevents the feet from slipping off of the side panels.

The slip-resistant surface should be checked periodically for wear or lack of grip and replaced if necessary.

In emergencies, dismount the treadmill as follows:

- Jump onto and straddle the side panels.
- The running surface can run between the legs.
- Then stop the treadmill using the normal STOP button or the emergency stop button.

An alternative is to stand on the side panel with both feet on one side of the running surface, right or left and to hold on to the railing. The STOP button or emergency stop button may then be used to bring the running belt to a stop.

 **WARNING**

Components Must Not Interfere With Use of Device!

Adjustment and safety components (e.g. emergency stop pull-cord, video railing, connected devices) must be secured properly so as not to interfere with the proper use and movement of the treadmill and user.

6 Setup & Installation

6.1 General

Setup & Installation is the initial intended use of the device (see Section 1.5 Page 15). Ensure that the conditions applicable to basic safety and health requirements are met. Read these operating instructions completely before installation.

Before installing the device, operational and functional safety are to be tested, including correct installation and operator instruction.

In most cases, your WOODWAY treadmill will be delivered completely assembled. Check immediately upon delivery for any signs of transportation damage and immediately report any damages to the transport company and WOODWAY.

Position the treadmill to ensure that the power cord can easily be accessed and disconnected when needed. Make sure it is not bent or angled such that it could disconnect.

ATTENTION

Installing after Storage or Transport

The formation of condensation on the cooled electronic parts may cause the treadmill to malfunction and damage the electronics.

- ▶ Before installing after storage or transport, the treadmill must stand at room temperature for approx. 3 hours to become acclimatized.

6.2 Grounding Information

This treadmill must be grounded. If it should malfunction or break down, grounding provides a path of least resistance for electrical current to reduce the risk of electric shock. This product is equipped with a grounded power cord.

⚠ WARNING

Connect Treadmill to Properly Grounded Outlet Only!

The treadmill plug must be inserted into an appropriate outlet that is properly installed and grounded in accordance with all local and national codes and ordinances.

- ▶ The supplied plug should not be manipulated in any way.
- ▶ If necessary, a qualified electrician may fit a suitable mains socket.
- ▶ Adapters may not be used because of the risk of electric shock.

6.3 Installation

It is recommended that transport, installation, and assembly of the treadmill are carried out by WOODWAY or by an authorized dealer or service provider. Otherwise, shipping damage or improper installation and assembly of the treadmill could cause a hazard when using the device.

ATTENTION

Prepare a Stable Surface

Before the device is installed, the surface must be prepared. The total weight of the device (with all the accessories and options) is to be considered.

- ▶ Prepare a stable and sturdy surface.
- ▶ Only install the device on a level, stable, and sufficiently sturdy surface.

If necessary, install an additional base plate/floorboard.

The following further instructions for installation are to be observed:

- When installed on upper floors, the device must be placed as far as possible in a corner of the room so that sufficient stability is guaranteed. The structure of the building must be checked in advance.
- The treadmill should not be installed close to a radiator or other heat source.
- Due to the moving parts on the underside, the device must not be placed directly on thick or high-pile carpeting. In this case, a mat should be placed under the device. This will prevent lint from entering into the treadmill and at the same time reduce carpet wear. WOODWAY has appropriate mats available. For more information, call WOODWAY Customer Service.
- With larger devices, particular attention must be paid to the ceiling/floor load capacity at the installation site. This must be higher than the total weight (weight of the device plus the dynamic weight of a running person) and approved by an authorized authority with the treadmill representative.
- Position the treadmill to ensure that the power cord can easily be accessed and disconnected when needed.

Safe Fall Area

When using the treadmill, especially fast movements (fast running, etc.) increase the risk of falling. For this reason, a safe fall area of at least 3 ft. x 6.5 ft. (1 x 2 m) must be maintained behind the treadmill (see Fig. 13 below).

No obstacles may be located in this safe fall area. Objects (e.g. furniture, plants, training materials, ladders, etc.) may not be placed in this area, and sloping ceilings may not extend into the safety area. WOODWAY treadmills have a reverse option. The safety area must therefore also be provided in front of the treadmill.

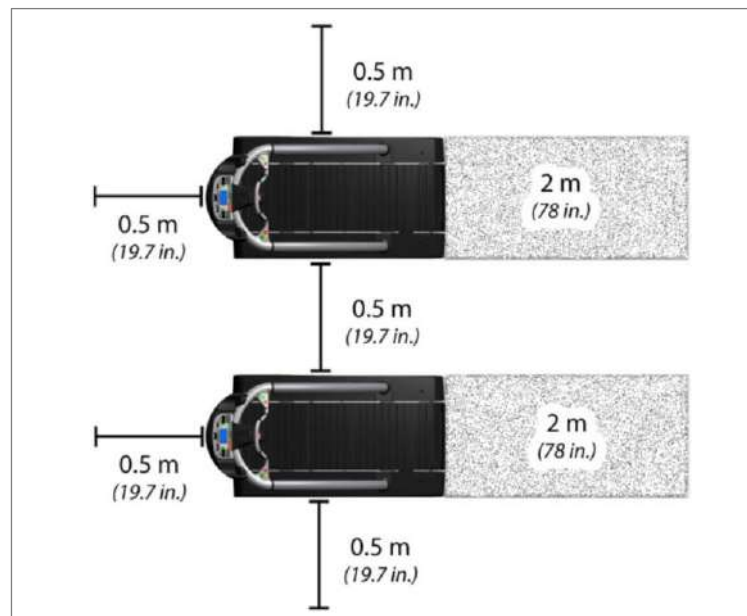

Fig. 13 Set-up, clearances

6.3.1 Adjust Leveling Feet

After positioning the device at the installation site, it may be necessary to adjust the horizontal height to compensate for a slightly uneven floor. The height of the 4 leveling feet can be adjusted.

- First remove the side covers using a Philips head screwdriver.



Fig. 14 Removing Side Covers

- Loosen the top counter nut with the specific wrench (see table below)
- Turn the bottom nut on which the frame rest until the desired height is reached.
- Retighten the top counter nut

Wrench needed	4Front, Desmo, Mercury, Path, Pro	Pro-XL
Front Feet	3/4" box wrench or socket wrench	15/16" box wrench or socket wrench
Rear Feet		1 1/8" box wrench or socket wrench

When making leveling adjustments, it is important to ensure that the frame of the treadmill does not twist. Lift the frame of the treadmill to check for approximately equal weight load.

6.3.2 Completion of Installation

Prior to starting operation, installation is to be completed with a trial run. During the trial run, all device functions are to be carried out and checked.

ATTENTION
<p>Check Device</p> <p>After the trial run has been carried out, all bolted connections, couplings, and other connections are to be checked for tightness.</p>

Checklist for Before Starting Operation

- Check sturdiness of the device
- Check electrical connections
- Protect all live components against touch
- Ensure that safety equipment is intact and functional
- Check emergency stop switch and all control functions
- Perform a malfunction-free trial run
- Ensure all operators have received complete and proper instruction

6.4 Assembly Instructions

6.4.1 Preparation

The treadmill can be delivered in various states of assembly. Disassembly/assembly may be required for moves or relocation into other rooms.

NOTE

In WOODWAY performance and fitness treadmills, standard (inch) screws and nuts are used, with few exceptions. These are not compatible with metric fastening elements!

Preparation Steps

Due to the heavy weight of the device, it is recommended to install the treadmill as close to its final location as possible.

Carefully dismantle the shipping crate. To do this, remove the screwed connections. Remove protective foil from all packaged parts. Ensure that the surfaces are not damaged by sharp objects (knife, etc.).

NOTE

It is recommended to have a second person assist in inserting the railing tubes or with the assembly.

6.4.2 4Front

Tools required for assembly:

- 1x combination wrench or ratchet wrench, 1/2"
- 1x Phillips head screwdriver, #2

1. Remove the covers on the left and right.



Fig. 15 4Front assembly, side panel

2. Insert wire and protective cover into the handrail tube to prevent damage during insertion.



Fig. 16 4Front assembly, wiring

3. Prepare the mount for the tube.

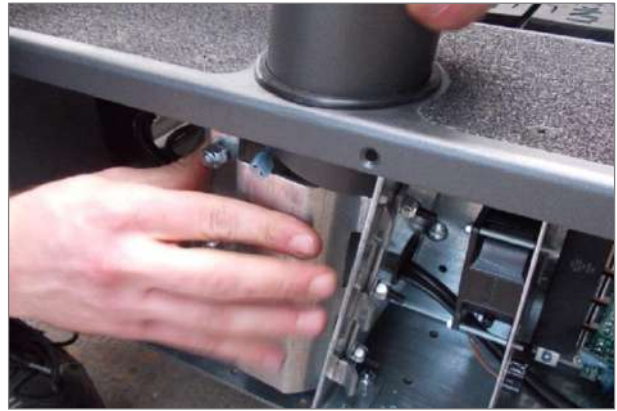

Fig. 17 4Front assembly, tube mount

4. Insert the handrail tube into the mounts.

Note: Do not damage the wires!
Be careful not to pinch yourself!



Fig. 18 4Front assembly, inserting tubes

5. Pull the wire and protective cover out of the handrail tube.

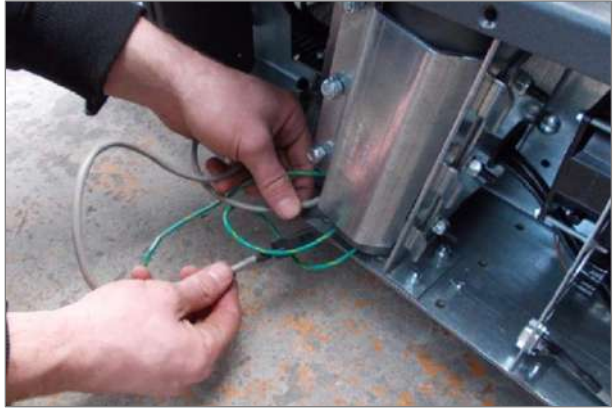

Fig. 19 4Front assembly, connection 1

6. Lay the wire with protective cover behind the handrail mount.

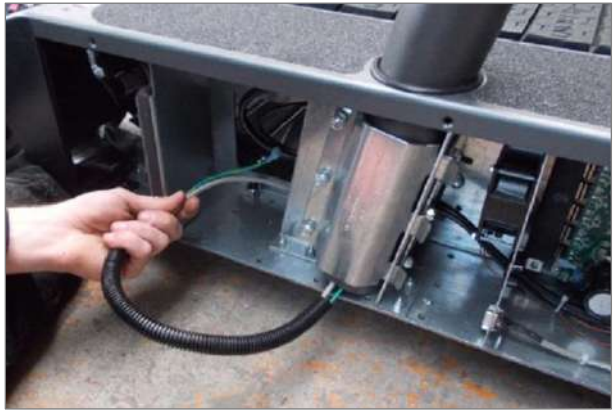

Fig. 20 4Front assembly, connection 2

7. Insert the Display plug and tighten both retaining screws.
8. Attach the protective conductor (green) to the contact tab on the frame.
9. Connect any other connections to the interface panel

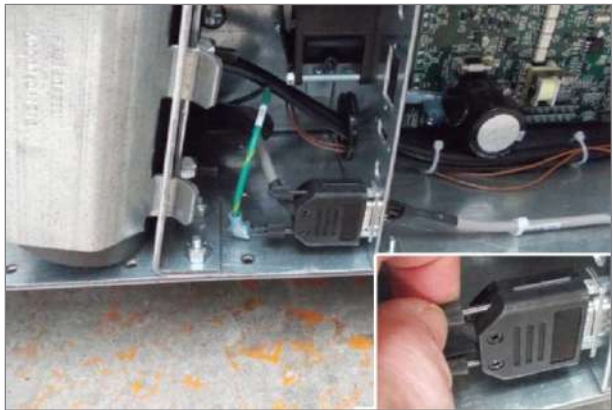

Fig. 21 4Front assembly, connection 3

10. Tighten handrail clamp bolts.



Fig. 22 4Front assembly, securing the railing

11. Replace the right and left side panels and secure them with screws.
12. Insert all screws by hand first, then tighten them down completely



Fig. 23 4Front assembly, side panel

6.4.3 Desmo

Tools required for assembly:

- 1x combination wrench or ratchet wrench, 1/2"
- 1x Phillips head screwdriver, #2

1. Remove the covers on the left and right.



Fig. 24 Desmo assembly, removing side covers

2. Insert wire and protective cover into the handrail tube to prevent damage during insertion.



Fig. 25 Desmo assembly, wiring

3. Prepare the mount for the tube.



Fig. 26 Desmo assembly, tube mount

4. Insert the handrail tube into the mounts on both sides.

Note: Do not damage the wires! Be careful not to pinch yourself!



Fig. 27 Desmo assembly, inserting tubes

5. Tighten the handrail mount bolts on both sides.

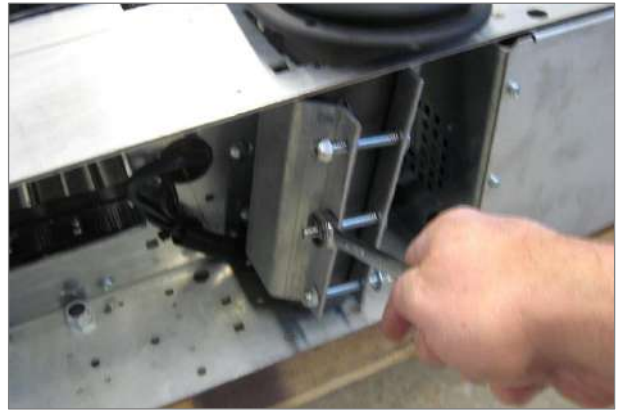

Fig. 28 Desmo assembly, fixing the railing

6. Remove electronic cover plate on the right side of the treadmill frame using a Phillips screw driver.



Fig. 29 Desmo assembly, electronic cover plate

7. Lay the wire through the hole in the console.



Fig. 30 Desmo assembly, connection 1

8. Attach the protective conductor (green) to the contact tab on the housing.



Fig. 31 Desmo assembly, connection 2

9. Connect the display cable to the circuit board. The connector is J10.
Note: Do not connect display cable to the position marked with the red "X" in Fig. 29!



Fig. 32 Desmo assembly, connection 3

10. Connect the wires to the frame with the supplied wire ties.
11. Connect and secure all other connections from hand-rail.

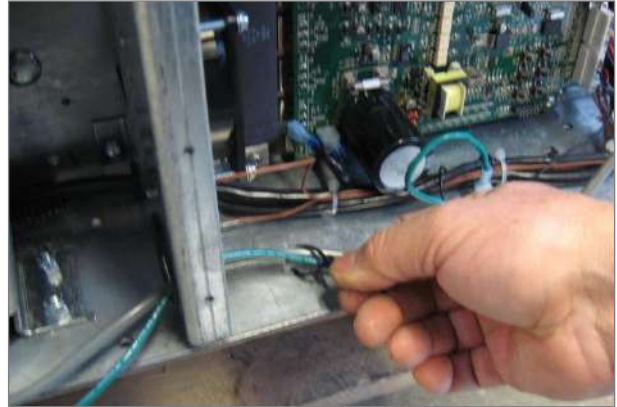

Fig. 33 Desmo assembly, connection 4

12. Reinstall electronic cover plate on the right side of the treadmill frame using a Phillips screw driver.



Fig. 34 Desmo assembly, electronic cover plate

13. Slide the side covers onto the left and right sides.
14. Guide the covers, slightly tilted under the handrail boots.
15. Attach the side covers and railing covers with screws (do not tighten the screws yet).



Fig. 35 Desmo assembly, side covers

16. Position the side covers so that a ¼ in. (5 mm) gap is visible.
17. Then tighten all screws.

Note: The side covers must not be in contact with the running surface or drive belts on the rear left side!

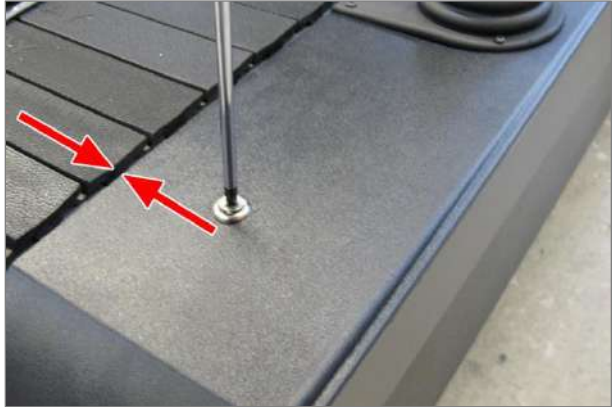

Fig. 36 Desmo assembly, adjusting side covers

6.4.4 ELG

Please contact your local representative for ELG assembly assistance.

6.4.5 Mercury, Path

Tools required for assembly:

- 1x combination wrench or ratchet wrench, ½"
- 1x Phillips head screwdriver, #2

1. Remove the cover plates and side covers on both sides.



Fig. 37 Mercury/Path assembly, side covers

2. Insert wire and protective cover into the guard rail tube to prevent damage during insertion.



Fig. 38 Mercury/Path assembly, wiring

3. Prepare the mount for the tube. Loosen bolts if necessary.



Fig. 39 Mercury/Path assembly, tube mount

4. Insert the railing tube into the mounts.

Note: Do not damage the wires!
Be careful not to pinch yourself!



Fig. 40 Mercury/Path assembly, insert tubes

5. Tighten railing mount bolts.

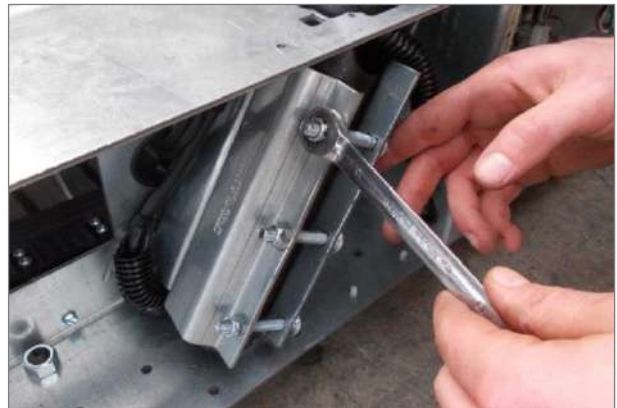

Fig. 41 Mercury/Path assembly, fixing the railing

6. Remove electronic cover plate on the right side of the treadmill frame.



Fig. 42 Mercury/Path assembly, electronic cover plate

7. Pull wire and protective cover out of the railing tube (hole in railing tube).



Fig. 43 Mercury/Path assembly, connection 1

8. Lay the wire with protective cover through the hole in the console.



Fig. 44 Mercury/Path assembly, connection 2

9. Attach the protective conductor (green) to the contact tab on the housing.

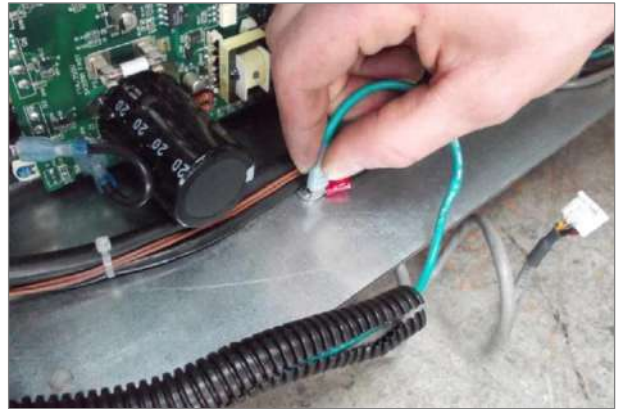

Fig. 45 Mercury/Path assembly, connection 3

10. Connect the display cable to the circuit board. The connection is J10.
11. Connect and secure all other connections from hand-rail.

Note: Do not connect to the position marked with the red "X" in Fig. 31!



Fig. 46 Mercury/Path assembly, connection 4

12. Reinstall electronic cover plate on the right side of the treadmill frame.



Fig. 47 Mercury/Path Assembly, electronic cover plate

- Slide the side covers on both sides and fix with screws (do not tighten the screws yet).



Fig. 48 Mercury/Path assembly, side covers

- Slide the cover plates over the tube on both sides and fix with screws.
- Tighten large screws first, then the rest.

Note: Ensure distance between side covers and running surface! The side covers must not be in contact with the drive belts on the rear left side!



Fig. 49 Mercury/Path assembly, cover plates

- Position the side covers so that a 1/4 in. (5 mm) gap is visible.
- Then tighten all screws.

Note: The side covers must not be in contact with the running surface or drive belts on the rear left side!



Fig. 50 Mercury/Path assembly, cover plates

6.4.6 Pro/Pro XL

Tools required for assembly:

- 1 x combination wrench, 1/2"
- 1 x ratchet wrench, 1/2"
- 1 x Phillips screwdriver, #2
- 1 x Allen key, 1/4"

1. Remove the cover plates and side covers on both sides.



Fig. 51 Pro/Pro XL assembly, side covers

2. Insert wire and protective cover into the handrail tube to prevent damage during insertion.



Fig. 52 Pro/Pro XL assembly, wiring

3. First slide the cover plates over the railing.
4. Insert both sides of the railing into the mounts.

Note: Do not damage the wires!

Be careful not to pinch yourself!



Fig. 53 Pro/Pro XL assembly, insert railing

5. Tighten railing mount bolts on the right side.

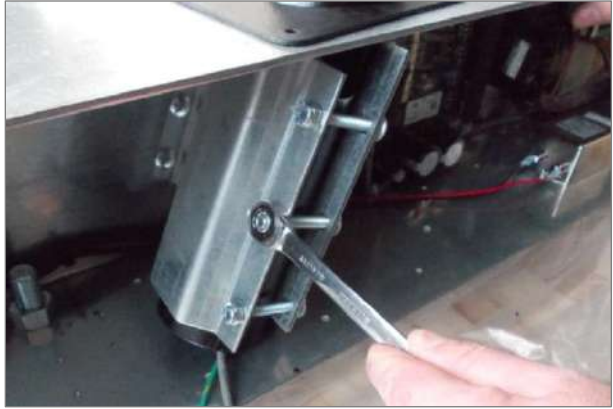

Fig. 54 Pro/Pro XL assembly, fixing the railing 1

6. Pull the wire and wire protection out of the side of the railing tube and lay it along the railing mount to the circuit board.



Fig. 55 Pro/Pro XL assembly, connection 1

7. Insert the display plug and tighten both retaining screws.
8. Attach the protective conductor (green) to the contact tab on the frame.
9. Connect any other connections to the interface panel.



Fig. 56 Pro/Pro XL assembly, connection 2

10. Tighten railing mount bolts on the left side.



Fig. 57 Pro/Pro XL assembly, fixing the railing 2

11. Slide the side covers on both sides and fix with screws.
12. Tighten large screws first, then the rest.

Note: Ensure distance between side covers and running surface!



Fig. 58 Pro/Pro XL assembly, side covers

6.5 Replacing Parts

For detailed descriptions of and instructions on replacing CONTINUUM parts, please see the CONTINUUM Service Manual.

NOTE

The use of NON-original replacement parts may change the characteristics of the device and interfere with the safe use. WOODWAY does not accept liability for damages resulting from this.

! DANGER

Danger of Death by Electric Shock!

Fatal electrical shock may occur if the unit is not disconnected from the power supply before assembly or disassembly.

- ▶ The device must be stopped, switched off, and unplugged before being worked on.
- ▶ Ensure the device cannot be switched back on.
- ▶ After the power is disconnected wait 10 minutes to ensure that live electrical components (e.g. capacitors) have discharged.

7 Operation

WARNING

Danger Through Uncontrolled Running Surface Movement!

By stepping on the rear-most part of the running surface where it is rounded, the force of gravity can set the running surface in motion. There is a danger of falling.

- ▶ Ensure that the user does not step on the rounded part of the running surface when mounting and dismounting.

7.1 For Your Safety

For safe operation and successful training please read the following points for your own safety before starting to use the treadmill:

- Keep hanging clothing and towels away from the running surface. Ensure that shoelaces do not extend beyond the bottom of the shoe sole.
- Keep the area behind the treadmill clear and make sure that there is a space of at least 78 in. (2 m) between the rear of the treadmill and walls or furniture.
- Keep hands away from all moving parts.
- Children and animals may not mount the treadmill! Never leave children or animals near the treadmill unattended.
- Check the treadmill for defective or loose components before use and replace or repair if necessary.
- Mount and dismount the treadmill carefully. Never mount or dismount the treadmill when the running surface is moving.
- For safety reasons and in the case of an emergency dismount, hold on to the railing and straddle the running surface with your feet on the left and right side panels.
- Do not dismount the treadmill until the running surface stops moving.
- Wear suitable running shoes with a high degree of grip. Do not use shoes with heels or leather soles or running shoes with spikes. To protect your device, ensure that there are no stones in your shoe soles.
- Take a few minutes to get your heart rate in the desired training range. Walk slowly for some time after a training session to give your body enough time to cool down. During this time your heart rate will go back to the normal range.
- Never let loose objects (e.g. balls) roll under the treadmill. They could be pulled into the device during operation.

ATTENTION

The user/owner or representative of the equipment is responsible for ensuring that regular maintenance and inspection of the treadmill is carried out.

Defective components must be replaced immediately. The treadmill should not be used until it is repaired by a professional.

7.2 Practical Training

NOTE

CONSULT A DOCTOR!

If you are over 40 years old, have a heart condition, are overweight, or have not been involved in an exercise program for several years, a visit to the doctor is recommended before beginning an intensive training program.

7.2.1 Professional Consultation

For all treadmill training beginners, it is recommended to seek the advice of a professional fitness instructor or personal trainer, to obtain an overall fitness assessment before starting an exercise program and develop an optimal training program.

For optimal use and safety during treadmill training, WOODWAY recommends running on the treadmill in an upright and natural running position and to avoid dragging foot movement.

7.2.2 Warm-Up and Cool-Down

A warm-up before each workout and a cool-down after each workout is recommended. If possible, you should always do some basic stretching exercises for the legs before and after training. The stretching exercises make you more flexible which prevents muscle soreness and injury during routine activities.

7.2.3 Proper Body Form

When running or walking, it is important to maintain proper form to maximize efficiency and results and minimize the possibility of personal injury.

Keep your posture upright; avoid leaning forwards or backwards from the waist, as this can cause unnecessary back strain and decrease your efficiency. Keep your head, shoulders, and hips in line with each other and aim to have your foot strike the running surface in line with your center of gravity (i.e. you should strike the running surface with the midfoot or forefoot). If you land on your heels, you are over-striding and should shorten your stride in order to increase momentum and overall efficiency.

Keep your arms at your sides, either relaxed and naturally pendulum-like (walking) or with a loose 90-degree angle, bending at the elbows (running). Do not allow your hands to cross the center of your body or your shoulders to move from side to side.

7.2.4 Training Frequency

At the beginning of training allow yourself enough time to get into shape. After a break from training, you should also allow sufficient time to rebuild physical condition.

Endurance Training

The priority is regularity and persistence of training - not intensity. Fitness experts recommend in the beginning training 3 - 4 times per week within your target heart rate for at least 20 minutes per workout. Your primary objective should be, step-by-step, to reach a level of fitness with which you can easily keep your heart rate in the target range for 50 to 60 minutes, 4 - 5 times per week.

Running Shoes

In order to prevent sore feet and sore muscles caused by incorrect footwear, the use of high quality running or jogging shoes is recommended. Ensure there is adequate heel and arch support.

7.2.5 Measuring Heart Rate

To select the optimum fitness levels for the workout, it is important to determine your heart rate and pulse as accurately as possible. For this, the use of a high-quality heart rate monitor is recommended.



In the event that you do not have a heart rate monitor, you can take your pulse by placing your fingers on the underside of your wrist or on one side of your neck. Look at the second hand of a clock and count how many beats you feel in 15 seconds. Multiply this number by 4 to calculate the BPM (beats per minute). Your heart rate is required when you do your fitness test.

7.2.6 Calculating Maximum Heart Rate

Determine Heart Rate For selecting the individual training intensity, it is important to determine one's own heart or pulse rate. For this, the use of a heart rate monitor is recommended. The pulse can also be determined by placing the middle and index fingers together on one side of the neck (a few centimeters outward from the larynx). Count the number of beats within a 15 second period and multiply by 4 to determine the beats per minute (BPM).

Maximum Heart Rate To determine your maximum heart rate subtract your age from the number 220 (general formula). The difference is an approximation of your maximum heart rate. This formula is used by the American Heart Association (AHA) and the American College of Sports Medicine (ACSM). Your actual maximum heart rate is determined by a stress test performed by your doctor. The American Heart Association recommends undergoing a stress test if you have a history of heart disease or if you are over 40 years old and starting an exercise program.

Heart Rate Recommendation During training it is recommended not to exceed a value of 85% of your maximum heart rate. Our programs are designed so that the heart rate remains within the target range. Your target range is between 60 and 75% of your maximum heart rate. If you find that your heart rate is above the 75%, you are probably running too fast. Reduce your speed or stop your workout for a brief moment to bring your heart rate back to the target range.

Use the following chart to determine your heart rate range:

Age	Maximum heart rate [BPM*]	60% of the maximum heart rate [BPM]	75% of the maximum heart rate [BPM]	85% of the maximum heart rate [BPM]
20	200	120	150	170
25	195	120	150	160
30	190	110	140	160
35	185	110	130	150
40	180	100	130	150
45	175	100	130	140
50	170	100	120	140
55	165	90	120	130
60	160	90	120	130
65	155	90	110	130
70	150	90	110	120
75	145	80	100	120

* **BPM:** Beats per minute, source: American College of Sports Medicine

7.2.7 Contact Heart Rate Measurement

Grips which are located on the front cross bar of the railing transmit the user's heart rate. The transmission begins when the user holds on to the grips. After starting the device, the user may hold his hands on the grips for a heart rate measurement at any time. Please wait 15 seconds to obtain an accurate heart rate reading. The user's heart rate is automatically displayed on the display panel under "Heart rate".

NOTE

The measurement of the heart rate via grips is not as exact as EKG and is only considered an approximation.

7.2.8 Heart Rate Monitors

The display was designed so that the user's heart rate is indicated when compatible heart rate transmitters are used, i.e. POLAR® measuring device (GymLink compatible) and ANT+ (4Front and Pro/Pro XL). In order to display the user's heart rate accurately on the screen, the built-in receiver display must receive a stable heart rate signal from the transmitter.

Please visit www.polar.com/us-en/support/compatibility_with_my_Polar and <http://www.thisisant.com/directory/> to view a full list of monitors and devices with POLAR® (GymLink) and ANT+ compatibility.

Heart rate measuring systems consists of three main elements:

- Sensor/transmitter
- Chest strap/belt or sport watch
- Measuring device/console

The receiver for the wireless system is installed in the measuring device assembly or the console display. When in operation the display shows the heart's activity in beats per minute (BPM).

! WARNING

Danger of Electrical Disturbance!

Using the transmitter from the heart rate monitor in conjunction with an electric pacemaker may cause electrical interference and influence the functionality. This could cause a health hazard.

- ▶ **Never** use the heart rate monitor together with an electric pacemaker.

7.2.8.1 Applying the Chest Strap

The transmitter should be applied centrally below the chest muscles. After the belt is fastened, pull it away from the chest by stretching the strap and moistening the conductive electrode strips which are located below the buttons. The transmitter operates automatically while it is worn. It does not work if the connection between the transmitter and the body is broken.



Fig. 59 Chest strap with POLAR® transmitter

Positioning The sensor/transmitter is to be worn below the chest and above the abdomen, preferably directly on the skin (not over clothing), logo to the outside. Moisten the contact surface of the transmitter in order to transmit the best signal possible from the body to the measuring device.

Cleaning The chest strap can be washed. Remove belt from the transmitter, taking care not to bend the electrodes. Wash the strap and electrodes with warm water and mild soap. Do not machine wash the electrodes and do not use alcohol or other harsh cleaning solvents. Since the transmitter can be activated by moisture, it should be wiped dry after cleaning. Never use force to clean the transmitter.

Transmission Signal The transmitter has a range of about 3 ft. (1 m). Depending on the model, the receiver is located in the display of the device or below the emergency-off switch on the railing. When positioning several treadmills next to each other ensure that a minimum distance between the devices is kept in order to avoid the interference of the transmission signals between runners.

7.2.8.2 Transmitter Function

The signal will only be transmitted if the transmitter is within 3 ft. (1 m) of the receiver. Note that variations in the heart rate display can occur when the transmitter is too close to other heart rate measuring devices. Maintain at least 3 ft. (1 m) distance from other devices.

NOTE

It is possible that the heart rate measurement reception is irregular or completely disrupted when the measuring device is too close to strong sources of electromagnetic radiation, for example, in the vicinity of overhead power lines, televisions, computers, electric motors, or other fitness equipment. Only one transmitter should be used within range of a receiver since the receiver might otherwise receive multiple signals and transmit inaccurate readings.

7.3 Before Each Use

Before the unit is put into operation, the following checks are to be performed:

- Running surface belt (dirt and damage to slats)
- Mechanical function of the bar railing (clamping screw must be hand-tight)
- Emergency stop magnet with pull-cord and clip attachment (damage and position)
- Fall protection equipment e.g. ropes, carabiners, waist belt, etc. (wear and functionality)

! WARNING

Danger of Being Pulled into Moving Parts!

In the event of a fall, long hair, loose clothing, shoe laces, or jewelry can be pulled into running surface entry points.

- ▶ Remove jewelry and tie up long hair before using the device.
- ▶ Ensure shoe laces do not extend beyond soles of running shoes.

7.4 Switching Device On/Off

NOTE

Ensure that NO emergency stop button or emergency stop mushroom is engaged. The emergency stop magnet with pull-cord must be attached to the field marked for this purpose.

The device cannot be operated without releasing the emergency stop function and attaching the magnet to the magnetic switch.

! WARNING

Danger of Device Moving Down When Switched On!

If the treadmill was in the inclined position prior to being switched off during previous use, the device will automatically move back to the neutral position (0% incline). There is a danger of injury.

- ▶ No one may be located in the area in front of the treadmill.
- ▶ No objects may be located under the treadmill.
- ▶ Check the position of the treadmill before switching it on.



To turn the device on, switch the power switch on the side of device frame (on the right) from position "O" to "I". The treadmill is now in STAND-BY mode.

Fig. 60 ON/OFF switch

When training is finished, switch the treadmill off again via the switch on the display. The device is in STAND-BY mode again.

! WARNING

Danger Through Speeding-Up of the Running Surface!

If the drive motor is stopped (e.g. by pressing the STOP button, emergency stop, or by power failure) when set at an incline, the weight of the user (gravity) may cause the running surface to accelerate.

- ▶ Use special caution when stopping the drive motor when set at an incline.
- ▶ Users must be made aware of dangers before use.

Switch the device off via the main switch on the power supply console when it will not be used for a long time.

ATTENTION

Do not move the running surface belt during the initialization phase (approx. 3-4 seconds). The movement can be interpreted as a device malfunction by the control electronics and the device will switch off.

- ▶ Never step on the running surface during the initialization phase.
- ▶ Do not leave the device until it switches back into STAND-BY mode.
- ▶ Never leave the treadmill unattended while it is switched on.

7.5 Using the Keypad

The keypad can be attached to a suitable point on the handrail so that the controls are easily accessible to the runner.

The magnetic mount makes it possible to remove the keypad from the railing. In this way the runner's supervisor can use the keypad as a remote control.

Switch device on as described in Section 7.4. Make sure that the emergency stop magnet is mounted on the magnetic switch with its pull-cord, the clip is fixed to the runner's clothes, and that all emergency stop buttons are released.

Button Functions The buttons on the keypad are used for setting the speed and incline. The corresponding speed or incline indicators are used for control. When the desired speed or incline has been reached, release the button.

[+] [-] Buttons With these buttons, the user can increase or decrease the speed. The running speed increases or decreases continually as long as the button is pressed. Watch the speed indicator on the display during the adjustment and release the button at the desired speed.

[↑] [↓] Buttons With these buttons, the user can adjust the incline of the device. The incline increases or decreases continually as long as the button is pressed. Watch the incline indicator on the display. Release the button at the desired incline.

STOP Button The treadmill can be stopped with the STOP button. The gradual braking of the running surface speed is comfortable, so the user still travels a few meters before the unit stops (depends on the previous speed). If the running surface belt is stopped, the treadmill goes to the STOP mode. The incline is maintained.

Pressing the STOP button a second time causes the treadmill - should it still be at an incline - to move back to its starting position (0% incline). The treadmill remains in STOP mode.

7.6 Standard Display

The keys on the display panels are membrane-type switches, with which complete control of the device is possible. The emergency switch is a magnetic sensor which detects the presence of a magnet and switches the treadmill off immediately when the magnet is removed.

There are 5 indicators, each with 7 segments with which program statistics are displayed. The 4-digit displays are programmed to display the time in the 00:00 format.

The numeric keypad (Path and Mercury only) is used for CSAFE compatibility and has no other function.



Fig. 61 Standard display I



Fig. 62 Standard display II



Fig. 63 Standard display III

7.6.1 Display Parameters

- Manual speed and incline control
- Statistics display: distance, calories, time, pace, heart rate, and METs
- Treadmill SPEED and INCLINE display
- Controlled increase/decrease of speed, safety checks, and automatic shut-off in case of errors

7.6.2 Training Parameters

Training Start	Press the FAST key to start training. The speed increases from "0". The time LED is lit and the time is displayed and counted in the TIME display in the 00:00 format. The DISTANCE and HEART RATE LEDs are lit and the corresponding values are displayed.
Active Controls	During training the user can change the incline using the UP/DOWN incline keys, and the speed using the FAST/SLOW speed keys. The user can interrupt the training at any time using the PAUSE key.
Pause Training	When the user presses the PAUSE key, the treadmill stops. The TIME display indicates "PAUSE" and the other 7-part displays maintain the values from the time that the PAUSE key was pressed. To begin training again, the user can press the PAUSE key again. The speed is increased to the former value and the TIME display starts counting the time.
Displayed Statistics	During training, the user can press the "PACE, CALORIES, METS" key to change between the values for the distance, time, and heart rate. The distance is replaced by calories, the time is replaced by pace, and the heart rate is replaced by METS. When the PACE, CALORIES, METS key is pressed again, the displays show the original values again. The LEDs for the respective statistics are lit.

End Training The user can press the OFF key at any time to end the training session. Speed and incline are reset to zero. The training statistics are displayed for 10 seconds. The time display shows the total time and the DISTANCE/CALORIES display shows the total distance and total calories burned alternately.

NOTE

The STOP key on the side switches corresponds to the OFF key on the screen.

7.6.3 Description of Display Elements

The indicators in the display indicate the following data:

- TIME** The time is displayed in 00:00 format. Time is always counted.
- SPEED** The speed is displayed in 00.0 format. The SPEED shows the user's current speed in miles per hour (MPH). Valid max. speeds vary depending on the model and applicable options.
- DISTANCE** The distance is displayed in 00.00 format. DISTANCE shows the accumulated user's distance in miles.
- CALORIES** The calories are displayed in 0000 format. CALORIES shows the user's accumulated burnt calories. They are calculated using the ACSM formula, $([\text{Workout METs}] * 3.5 * [\text{User's weight in kg.}] / 200)$. If no weight is entered, the calories are calculated based on a standard weight of 150 lbs. (70 kg).
- PACE** The time/mile is displayed in 00:00 format. PACE represents the time required to run one mile at the current speed.
- METS** METs are displayed in 00.0 format and are calculated using the ACSM formula, $(\text{VO2 Max} / 3.5)$, where the walking VO2 Max is $(3.5 + [2.68 * \text{speed in MPH}] + [0.48 * \text{speed in MPH}] * [\% \text{ grade}])$ and the running VO2 Max is $(3.5 + [5.36 * \text{speed in MPH}] + [0.24 * \text{speed in MPH}] * [\% \text{ grade}])$.
- HEART RATE** The heart rate is displayed in 000 format. It represents the user's actual heart rate.
- INCLINE** The incline display is used to show the user's current incline or to set the incline. Valid incline values start at 0% and increase in steps of 0.1% to the max. incline (varies depending on the model and the associated options).

7.7 Group Training Display

The keys on the display panels are membrane-type switches, with which complete control of the device is possible. The emergency switch is a magnetic sensor which detects the presence of a magnet and switches the treadmill off immediately when the magnet is removed.

There are 5 indicators, each with 7 segments with which program statistics are displayed. The 4-digit displays are programmed to display the time in the 00:00 format.

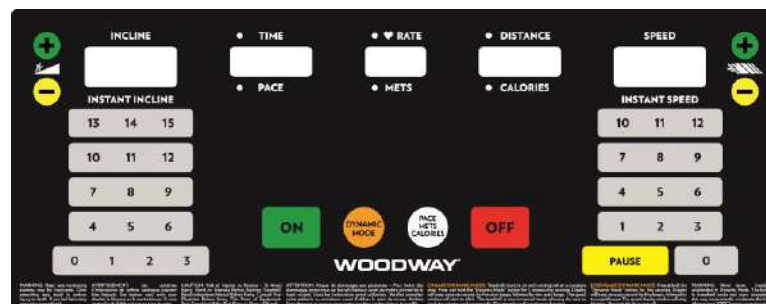

Fig. 64 Group Training Display

7.7.1 Display Parameters

- Manual speed and incline control
- Quickset speed and incline control
- Statistics display: distance, calories, time, pace, heart rate, and METs
- Treadmill SPEED and INCLINE display
- Controlled increase/decrease of speed, safety checks, and automatic shut-off in case of errors

7.7.2 Training Parameters

Training Start	Press the FAST key to start training. The speed increases from "0". The time LED is lit and the time is displayed and counted in the TIME display in the 00:00 format. The DISTANCE and HEART RATE LEDs are lit and the corresponding values are displayed.
Manual Controls	During training the user can change the incline using the UP/DOWN incline keys, and the speed using the FAST/SLOW speed keys. The user can interrupt the training at any time using the PAUSE key.
Quickset Controls	During training, the user can use the quickset speed and incline control keys to more quickly change the speed or incline to the desired level. To set the speed or incline to a value between those available using quickset keys, select the nearest quickset value key and then use the manual controls as described above to adjust to the desired value.
Pause Training	When the user presses the PAUSE key, the treadmill stops. The TIME display indicates "PAUSE" and the other 7-part displays maintain the values from the time that the PAUSE key was pressed. To begin training again, the user can press the PAUSE key again. The speed is increased to the former value and the TIME display starts counting the time.
Displayed Statistics	During training, the user can press the "PACE, CALORIES, METS" key to change between the values for the distance, time, and heart rate. The distance is replaced by calories, the time is replaced by pace, and the heart rate is replaced by METS. When the PACE, CALORIES, METS key is pressed again, the displays show the original values again. The LEDs for the respective statistics are lit.
End Training	The user can press the OFF key at any time to end the training session. Speed and incline are reset to zero. The training statistics are displayed for 10 seconds. The time display shows the total time and the DISTANCE/CALORIES display shows the total distance and total calories burned alternately.

NOTE

The STOP key on the side switches corresponds to the OFF key on the screen.

7.7.3 Description of Display Elements

The indicators in the display indicate the following data:

- TIME** The time is displayed in 00:00 format. Time is always counted.
- SPEED** The speed is displayed in 00.0 format. The SPEED shows the user's current speed in miles per hour (MPH). Valid max. speeds vary depending on the model and applicable options.
- DISTANCE** The distance is displayed in 00.00 format. DISTANCE shows the accumulated user's distance in miles.
- CALORIES** The calories are displayed in 0000 format. CALORIES shows the user's accumulated burnt calories. They are calculated using the ACSM formula, $([\text{Workout METs}] * 3.5 * [\text{User's weight in kg.}] / 200)$. If no weight is entered, the calories are calculated based on a standard weight of 150 lbs. (70 kg).
- PACE** The time/mile is displayed in 00:00 format. PACE represents the time required to run one mile at the current speed.
- METS** METs are displayed in 00.0 format and are calculated using the ACSM formula, $(\text{VO2 Max} / 3.5)$, where the walking VO2 Max is $(3.5 + [2.68 * \text{speed in MPH}] + [0.48 * \text{speed in MPH}] * [\% \text{ grade}])$ and the running VO2 Max is $(3.5 + [5.36 * \text{speed in MPH}] + [0.24 * \text{speed in MPH}] * [\% \text{ grade}])$.
- HEART RATE** The heart rate is displayed in 000 format. It represents the user's actual heart rate.
- INCLINE** The incline display is used to show the user's current incline or to set the incline. Valid incline values start at 0% and increase in steps of 0.1% to the max. incline (varies depending on the model and the associated options).

7.8 Personal Trainer Display

The keys in the display panel are membrane type switches which allow the user to type in command parameters to control treadmill operation. The user can also monitor training progress. There are 5 indicators each with 7 segments with which program statistics are displayed.

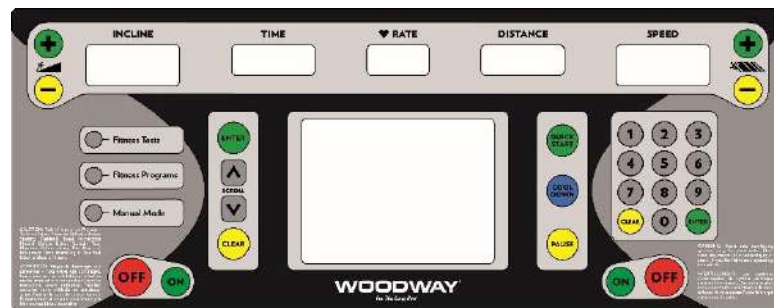

Fig. 65 Personal trainer display I



Fig. 66 Personal trainer display II



Fig. 67 Personal trainer display III

In the LCD display with a resolution of 320 x 240 pixels, the user's program selection profile and the progress during training are shown. With the program profiles, the speed and incline curves are shown in charts.

The heart rate is measured using an ANT+ and POLAR® compatible receiver. In addition, there is an EKG heart rate sensor in the railing for measuring the heart rate through grip.

NOTE

The measurement of the heart rate via grips is not as exact as EKG and is only considered an approximation.

Operating Functions

The user can control and display the following functions using the operator keypad:

- Manual speed and incline control
- Statistics display of speed, incline, time, calories, METs, pace, distance, and heart rate
- 10 integrated programs including manual operation
- 99 user modifiable programs
- Automatic speed and incline adjustment in programs
- Controlled increase/decrease of speed, safety checks, and automatic shut-off in case of errors

Displayed Information

The following values appear in the personal trainer display to allow the user to monitor his progress:

- Speed profile
- Incline profile
- Time/ height
- METs
- Calories/distance
- Pace
- Heart rate
- Calories per hour

7.8.1 Description of Display Elements

- TIME** The time is displayed in 00:00 format. In the user-defined mode, the time is counted up from zero. In the program modes, the time is counted down.
- SPEED** The speed is displayed in 00.0 format. SPEED represents the user's current speed in miles per hour (MPH), or it may be used to set the user's target speed. Valid speeds range from 0.0 to the max. speed (varies depending on the model and applicable options).
- DISTANCE** The distance is displayed in 00.00 format. DISTANCE shows the accumulated user's distance in miles. The distance is accumulated until the program is terminated or the user presses the PAUSE button.
- CALORIES** The calories are displayed in 0000 format. CALORIES shows the user's accumulated burnt calories. They are calculated using the ACSM formula, $([\text{Workout METs}] * 3.5 * [\text{User's weight in kg.}] / 200)$. If no weight is entered, the calories are calculated based on a standard weight of 150 lbs. (70 kg).
- PACE** The pace is displayed in 00:00 format. TIME represents the time required to run one mile at the current speed.
- METS** METs are displayed in 00.0 format and are calculated using the ACSM formula, $(\text{VO}_2 \text{ Max} / 3.5)$, where the walking $\text{VO}_2 \text{ Max}$ is $(3.5 + [2.68 * \text{speed in MPH}] + [0.48 * \text{speed in MPH}] * [\% \text{ grade}])$ and the running $\text{VO}_2 \text{ Max}$ is $(3.5 + [5.36 * \text{speed in MPH}] + [0.24 * \text{speed in MPH}] * [\% \text{ grade}])$.
- HEART RATE** The heart rate is displayed in 000 format. It represents the user's actual heart rate.
- INCLINE** The INCLINE display is used to show the user's current incline or to set the incline. Valid incline values start at 0% and increase in steps of 0.1% to the max. level of incline (varies depending on the model and the associated options).

7.8.2 Quick Start (User-Defined Operation)

1. First, ensure that the treadmill is plugged into the power supply and that the power switch (cutout in the side cover bottom right) is switched on.
2. Check that the emergency stop magnet is in place.
3. To turn the display press and hold the ON key until the LED and LCD displays are lit. All functions can now be operated using the mentioned surrounding keys:
 - Quick Start
 - Manual Mode (with weight entry)
 - Fitness programs
 - Fitness tests

Note: All specified options are located on the far left of the display and can be selected there directly.

7.8.3 Quick Start Display Parameter

The time is counted up from zero, the speed starts at 0.1 MPH and the distance traveled and calories are accumulated. Speed is input directly by the user using either the FAST/SLOW keys or the number pad. An oval ¼ mile (400-meter) track is displayed on the LCD display. A blinking point which represents the user's position moves around the track (counter-clockwise). In the middle of the track "Lap = 0" is displayed. Each lap around the track represents ¼ mile (400 m). The lap counter counts each completed lap.

During training in user defined mode, the user can change the incline using the UP/DOWN incline keys, and the speed using the FAST/SLOW speed keys. The user can interrupt the training at any time by pressing the PAUSE key.

The user course is laid out as shown in the following figure:

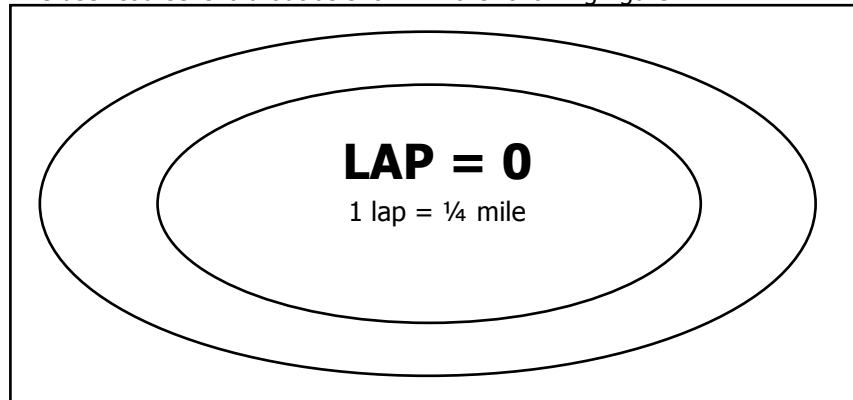

Fig. 68 User-defined track

Pausing Workout

When the user presses the PAUSE key, the treadmill slows to a stop. The following information is shown on the LCD display: "Treadmill Paused. Press PAUSE to resume".

The statistics are paused when the PAUSE key is pressed. When the user presses the PAUSE key again, the workout resumes. The CLEAR key is activated during the pause. Pressing the CLEAR key will reset all of the treadmill statistics.

The statistics are displayed in the bottom of the screen throughout the training. It displays the information PACE, CALORIES, CAL/HOUR, VERTICAL, and METS.

7.8.4 Starting a Training Program

Before starting a training program, it is advisable to consult a certified training professional or doctor. The program setup is started by pressing the FITNESS PROGRAMS button on the left side of the screen (or by selecting this option in the main START menu). Once you are in a program, you must use the number keys or the FAST/SLOW keys to set all required values. Scroll to change fields.

Entering the Difficulty Level

The program profile and the program title are displayed in the LCD display. The standard difficulty level 1 is displayed. The program profile is initially displayed at a higher level in order to better recognize the process. The desired difficulty level can be entered using the number keys. When selecting a difficulty level, the user should consider his current level of fitness and training goals. The current training level can be deleted using the CLEAR key. When the user has finished entering the desired training level, press the scroll key to confirm the entry and enter to the next value.

Entering Program Time

The program time must be entered. The default time of 20:00 is displayed. The user can enter the desired training duration using the number keys. The current time can be deleted using the CLEAR key. When the user has finished entering the desired training duration, press the scroll key to confirm the entry and enter to the next value.

Entering Weight

Next the user's weight must be entered. For a quick start, the user can bypass the weight menu by simply pressing the FAST key and accepting the standard weight of 150 lbs. (70 kg). He can then start the user-defined training or enter a weight using the key-

pad. Valid weight values are 50-500 lbs. (22-227 kg). The current weight can be deleted using the CLEAR key. When the user has finished entering the weight, he can press the ENTER key to confirm the entry and begin training.

- Program Start** The time is counted down to zero, then speed and incline will be set to the first segment values. Distance and calories are accumulated. The program profile is shown on the LCD display. The number keys, CLEAR key, and ENTER key are now deactivated.
- Usable Variables** While the program is running the user can change the incline using the UP/DOWN incline keys, and the speed using the FAST/SLOW speed keys. The user can interrupt the training at any time by pressing the PAUSE key. The status of the selected program lights up to show progress. The signal sounds 3 seconds before the speed and/or incline changes.
- Pausing During Training** When the PAUSE key is pressed, the treadmill stops. The following information is shown on the LCD display: "Treadmill Paused. Press PAUSE to resume." The statistics are paused when the PAUSE key is pressed. When the user presses the PAUSE key again, the workout resumes. The CLEAR key is activated during the pause. Pressing the CLEAR key will reset all the treadmill statistics and return the user to the opening screen (the LCD display shows the message "Press 'FAST' for Quick Start or select a program").
- Displaying the Statistics** The statistics are displayed at the bottom of the screen throughout training. Here information such as PACE, CALORIES, CALORIES/HR, VERTICAL FEET, and METs can be found.
- Program End** When the program is completed, the LCD will read "Program Complete" for 3 seconds. Speed and incline are then reset to zero.
When the OFF key is pressed, speed and incline reset to zero. "TOTALS: PACE= 00:00, CALORIES = 0000, METs =0.00" will be displayed on the LCD for 5 seconds. Then the display will then switch off.

7.8.5 Fitness Programs

Heart Rate Control

Follow the instructions below to begin the Heart Rate Control fitness program.

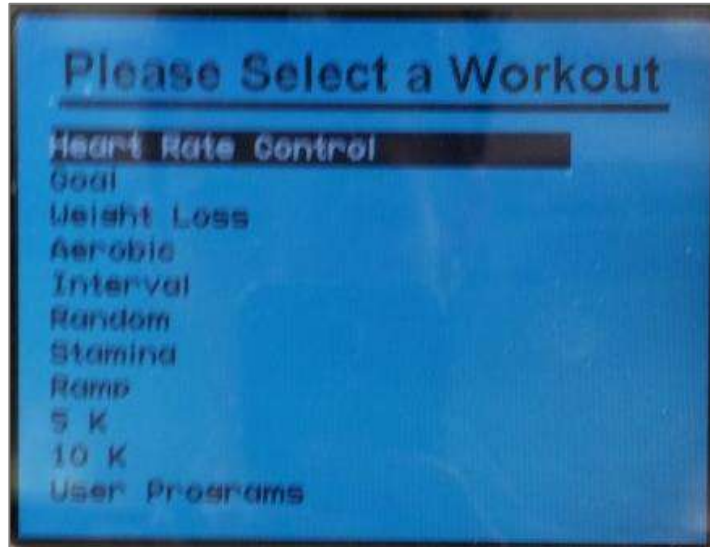

Fig. 69 Fitness Programs menu - Heart Rate Control

NOTE

The automatic heart rate programs can only work effectively if you wear a chest strap for heart rate measurement!

1. To open the program setup screen, first press the FITNESS PROGRAMS button on the left side of the screen. Once there, use the SCROLL keys to highlight the "Heart Rate Control" program (if it is not highlighted already) and then press ENTER.
2. When the automatic heart rate program has been selected, the user is prompted to enter his AGE, TARGET HEART RATE, MAXIMUM SPEED, MAXIMUM TIME, and WEIGHT on the initial screen. AGE can be entered using the number pad.
 - Valid age entries are 15–100.
 - The current age can be deleted using the CLEAR key.
 - Use the SCROLL keys to move to the next field.
 - When the age is changed, the target heart rate changes automatically.
3. Proceed to the next field once the displayed values are correct.
4. The target heart rate can also be entered using the number pad. After the correct value has been entered, the SCROLL keys can be used to move to the next field. The user must select the control type by using the FAST/SLOW keys (i.e. SPEED ONLY, INCLINE ONLY, or BOTH).

If the automatic heart rate program is selected with "SPEED ONLY" or "BOTH" criteria, the user must next select the maximum speed using the number keys. Use the SCROLL keys to complete the entry by entering the user's weight and maximum time (or just press ENTER to use the current values).

When training begins, the automatic heart rate profile is displayed on the LCD display. Above the profile illustration, a title will be displayed which indicates what kind of heart rate program is being used.



Fig. 70 Live data screen - Heart Rate Control

NOTE

The value 0.1 MPH can be seen in the speed display. To actually start the workout you must manually select the speed of the device. The heart rate program will take over control of the speed after a few seconds.

While using the program, the user can change the incline and speed. The target heart rate can be changed at any time while the heart rate program is being executed. The user can enter a new target heart rate using the number keys. Press the CLEAR key to delete the newly entered target heart rate. Press the ENTER key to confirm it.

Only one of the heart rate program types can be used during training. The user selects the desired algorithm during program setup.

Heart Rate Control, Incline Only

This program only controls the incline. The user selects the speed.

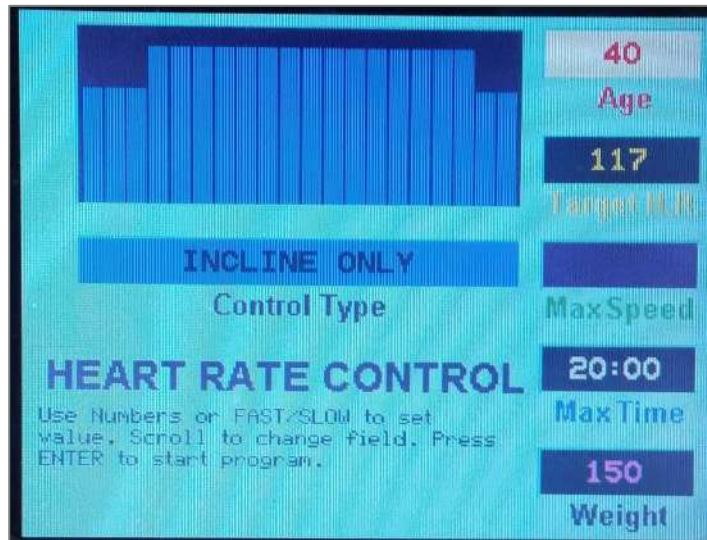

Fig. 71 Heart Rate Control - Incline Only

Program Start The time is counted down to zero, and then speed and incline will be set to the first segment values. Distance and calories are accumulated. The program profile is shown on the LCD display. The number keys, CLEAR key, and ENTER key are now deactivated.

Usable Variables While the program is running the user can change the incline using the UP/DOWN incline keys, and the speed using the FAST/SLOW speed keys. The user can interrupt the training at any time by pressing the PAUSE key. The status of the selected program lights up to show progress. The signal sounds 3 seconds before the speed and/or incline changes.

Pausing During Training When the PAUSE key is pressed, the treadmill stops. The following information is shown on the LCD display: "Treadmill Paused. Press PAUSE to resume." The statistics are paused when the PAUSE key is pressed. When the user presses the PAUSE key again, the workout resumes. The CLEAR key is activated during the pause. Pressing the CLEAR key will reset all the treadmill statistics and return the user to the opening screen (the LCD display shows the message "Press 'FAST' for Quick Start or select a program").

Displaying the Statistics The statistics are displayed at the bottom of the screen throughout training. Here information such as PACE, CALORIES, CALORIES/HR, VERTICAL FEET, and METs can be found.

Program End When the program is completed, the LCD will read "Program Complete" and the SPEED is then reset to zero.
When the OFF key is pressed, speed and incline reset to zero and the display will then switch off.

The heart rate control (only incline) program functions as follows:

- If the actual heart rate is 80 beats per minute (BPM) below the target, the incline is not adjusted. As a result, proper warm-up phase is possible.
- If the actual heart rate is 26-80 BPM below the target, the incline will increase 1% after 15 seconds.
- If the actual heart rate is 6-25 BPM below the target, the incline will increase 1% after 30 seconds.
- If the actual heart rate is 3-25 BPM below the target, the incline will increase 0.5% after 30 seconds.
- If the actual heart rate is at least 3 BPM above the target, the incline will decrease 1% after 15 seconds.
- There is no adjustment when the actual heart rate deviates from the target by a maximum of 2 BPM.

Heart Rate Control, Speed Only This program only controls the speed. The user selects the incline.



Fig. 72 Heart Rate Control - Speed Only

Program Start The time is counted down to zero, and then speed and incline will be set to the first segment values. Distance and calories are accumulated. The program profile is shown on the LCD display. The number keys, CLEAR key, and ENTER key are now deactivated.

Usable Variables While the program is running the user can change the incline using the UP/DOWN incline keys, and the speed using the FAST/SLOW speed keys. The user can interrupt the training at any time by pressing the PAUSE key. The status of the selected program lights up to show progress. The signal sounds 3 seconds before the speed and/or incline changes.

Pausing During Training When the PAUSE key is pressed, the treadmill stops. The following information is shown on the LCD display: "Treadmill Paused. Press PAUSE to resume." The statistics are paused when the PAUSE key is pressed. When the user presses the PAUSE key again, the workout resumes. The CLEAR key is activated during the pause. Pressing the CLEAR key will reset all the treadmill statistics and return the user to the opening screen (the LCD display shows the message "Press 'FAST' for Quick Start or select a program").

Displaying the Statistics The statistics are displayed at the bottom of the screen throughout training. Here information such as PACE, CALORIES, CALORIES/HR, VERTICAL FEET, and METs can be found.

Program End When the program is completed, the LCD will read "Program Complete" and the SPEED is then reset to zero.

When the OFF key is pressed, speed and incline reset to zero and the display will then switch off.

The heart rate control (only speed) program functions as follows:

- If the actual heart rate is 80 beats per minute (BPM) below the target, the speed is not adjusted. As a result, proper warm-up phase is possible.
- If the actual heart rate is 26-80 BPM below the target, the speed will increase 0.4 MPH (0.64 km/h) after 8 seconds.
- If the actual heart rate is 6-25 BPM below the target, the speed will increase 0.2 MPH (0.32 km/h) after 15 seconds.
- If the actual heart rate is 3-5 BPM below the target, the speed will increase 0.1 MPH (0.16 km/h) after 15 seconds.
- If the actual heart rate is at least 3 BPM above the target, the speed will decrease 0.2 MPH (0.32 km/h) after 15 seconds.
- There is no adjustment when the actual heart rate deviates from the target by a maximum of 2 BPM.

Heart Rate Control, Both

This program controls the incline as well as the speed.

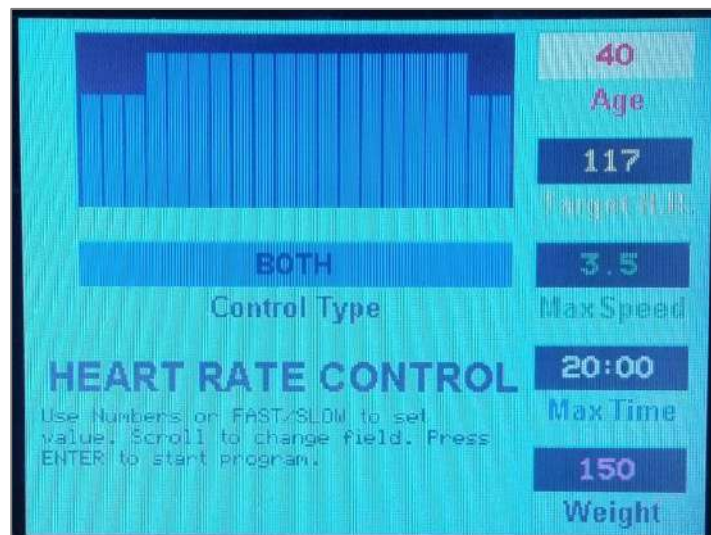

Fig. 73 Heart Rate Control - Both

Program Start	The time is counted down to zero, and then speed and incline will be set to the first segment values. Distance and calories are accumulated. The program profile is shown on the LCD display. The number keys, CLEAR key, and ENTER key are now deactivated.
Usable Variables	While the program is running the user can change the incline using the UP/DOWN incline keys, and the speed using the FAST/SLOW speed keys. The user can interrupt the training at any time by pressing the PAUSE key. The status of the selected program lights up to show progress. The signal sounds 3 seconds before the speed and/or incline changes.
Pausing During Training	When the PAUSE key is pressed, the treadmill stops. The following information is shown on the LCD display: "Treadmill Paused. Press PAUSE to resume." The statistics are paused when the PAUSE key is pressed. When the user presses the PAUSE key again, the workout resumes. The CLEAR key is activated during the pause. Pressing the CLEAR key will reset all the treadmill statistics and return the user to the opening screen (the LCD display shows the message "Press 'FAST' for Quick Start or select a program").
Displaying the Statistics	The statistics are displayed at the bottom of the screen throughout training. Here information such as PACE, CALORIES, CALORIES/HR, VERTICAL FEET, and METs can be found.
Program End	<p>When the program is completed, the LCD will read "Program Complete" and the SPEED is then reset to zero.</p> <p>When the OFF key is pressed, speed and incline reset to zero and the display will then switch off.</p> <p>The heart rate control (incline and speed) program functions as follows, following the above algorithms:</p> <ul style="list-style-type: none">• The speed is increased in increments until 80% of the user's maximum speed is reached (calculation based on user training level input).• The incline is increased in increments until 10% of the maximum treadmill incline is reached.• The speed is increased in increments until the user's maximum speed is reached.• The incline is increased until the maximum treadmill incline is reached.

Goal Program

This is a conditioning program, designed to build strength and endurance, that requires peak performance in the middle of training. These programs build strength and endurance.

1. To open the program setup screen, press the FITNESS PROGRAMS button on the left side of the screen. Then use the SCROLL keys to highlight the "GOAL" program and press ENTER to select.
2. Once in the program setup screen, use the SCROLL keys to toggle between LEVEL, TIME, and WEIGHT fields. Adjust to the desired values using either the FAST/SLOW keys or the number pad. Once desired settings are displayed, press ENTER to begin.

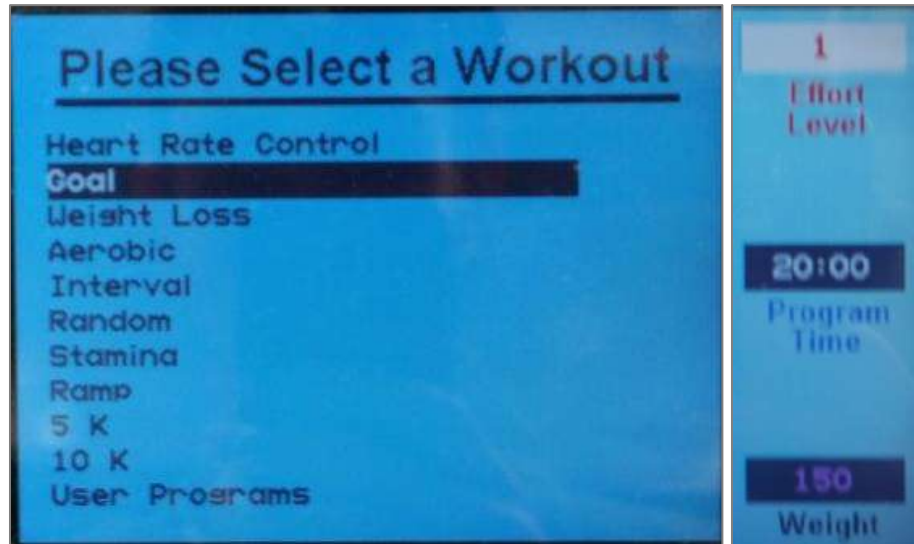

Fig. 74 Fitness Programs menu and data entry - Goal

Program Start

The time is counted down to zero, and then speed and incline will be set to the first segment values. Distance and calories are accumulated. The program profile is shown on the LCD display. The number keys, CLEAR key, and ENTER key are now deactivated.

Usable Variables

While the program is running, the user can change the incline using the UP/DOWN incline keys, and the speed using the FAST/SLOW speed keys. The user can interrupt the training at any time by pressing the PAUSE key. The status of the selected program lights up to show progress. The signal sounds 3 seconds before the speed and/or incline change.

Pausing During Training

When the PAUSE key is pressed, the treadmill stops. The following information is shown on the LCD display: "Treadmill Paused. Press PAUSE to resume." The statistics are paused when the PAUSE key is pressed. When the user presses the PAUSE key again, the workout resumes. The CLEAR key is activated during the pause. Pressing the CLEAR key will reset all the treadmill statistics and return the user to the opening screen (the LCD display shows the message "Press 'FAST' for Quick Start or select a program").

Displaying the Statistics

The statistics are displayed at the bottom of the screen throughout training. Here information such as PACE, CALORIES, CALORIES/HR, VERTICAL FEET, and METs can be found.

Program End

When the program is completed, the LCD will read "Program Complete" and the SPEED is then reset to zero.

When the OFF key is pressed, speed and incline reset to zero and the display will then switch off.

Stage

		SPEED DATA																			
		1	2	3	4	5	6	7	8	9	10	11	12	13	14	15	16	17	18	19	20
Level/	1	0.5	0.5	0.6	0.6	0.7	0.8	0.9	1.0	1.1	1.2	1.2	1.1	1.0	0.9	0.8	0.7	0.6	0.6	0.5	0.5
	2	0.9	1.0	1.1	1.2	1.4	1.6	1.8	2.0	2.2	2.4	2.4	2.2	2.0	1.8	1.6	1.4	1.2	1.1	1.0	0.9
	3	1.4	1.5	1.7	1.8	2.1	2.4	2.7	3.0	3.3	3.6	3.6	3.3	3.0	2.7	2.4	2.1	1.8	1.7	1.5	1.4
	4	1.8	2.0	2.2	2.4	2.8	3.2	3.6	4.0	4.4	4.8	4.8	4.4	4.0	3.6	3.2	2.8	2.4	2.2	2.0	1.8
	5	2.3	2.5	2.8	3.0	3.5	4.0	4.5	5.0	5.5	6.0	6.0	5.5	5.0	4.5	4.0	3.5	3.0	2.8	2.5	2.3
	6	2.7	3.0	3.3	3.6	4.2	4.8	5.4	6.0	6.6	7.2	7.2	6.6	6.0	5.4	4.8	4.2	3.6	3.3	3.0	2.7
	7	3.2	3.5	3.9	4.2	4.9	5.6	6.3	7.0	7.7	8.4	8.4	7.7	7.0	6.3	5.6	4.9	4.2	3.9	3.5	3.2
	8	3.6	4.0	4.4	4.8	5.6	6.4	7.2	8.0	8.8	9.6	9.6	8.8	8.0	7.2	6.4	5.6	4.8	4.4	4.0	3.6
	9	4.1	4.5	5.0	5.4	6.3	7.2	8.1	9.0	9.9	10.8	10.8	9.9	9.0	8.1	7.2	6.3	5.4	5.0	4.5	4.1
	10	4.5	5.0	5.5	6.0	7.0	8.0	9.0	10.0	11.0	12.0	12.0	11.0	10.0	9.0	8.0	7.0	6.0	5.5	5.0	4.5
STG	5.0	5.0	6.0	6.0	6.0	5.0	5.0	4.0	4.0	4.0	4.0	4.0	4.0	5.0	5.0	6.0	6.0	6.0	5.0	5.0	

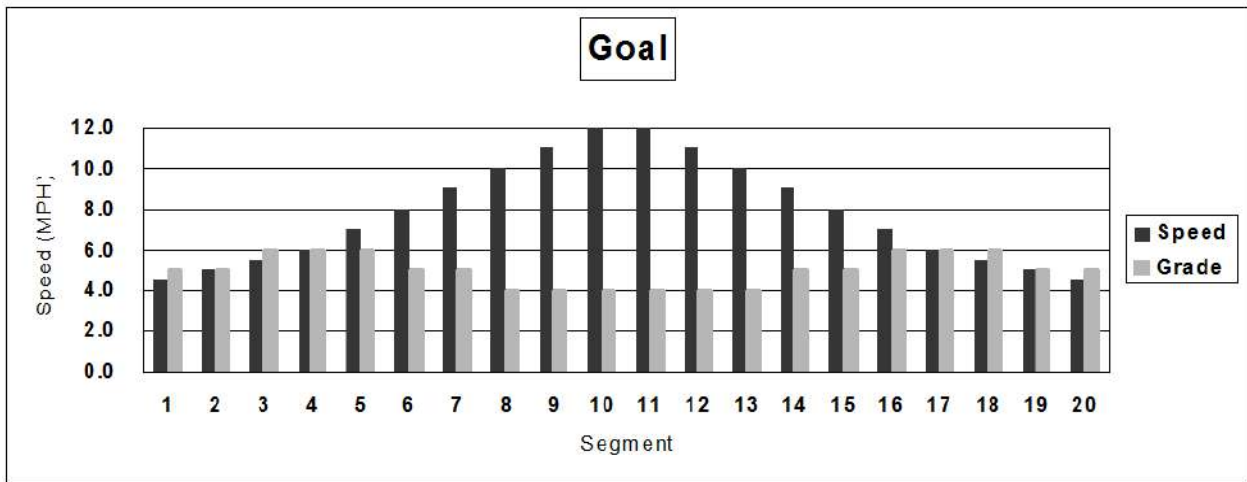

Fig. 75 Fitness Program level outline – Goal

Weight Loss Program

Designed to provide exercise at a constant level, this program utilizes a constant load and gradual warm-up and cool-down phases.

Follow the instructions below to begin the Weight Loss fitness program.

1. To open the program setup screen, press the FITNESS PROGRAMS button on the left side of the screen. Then use the SCROLL keys to highlight the "WEIGHT LOSS" program and press ENTER to select.
2. Once in the program setup screen, use the SCROLL keys to toggle between LEVEL, TIME, and WEIGHT fields. Adjust to the desired values using either the FAST/SLOW keys or the number pad. Once desired settings are displayed, press ENTER to begin.

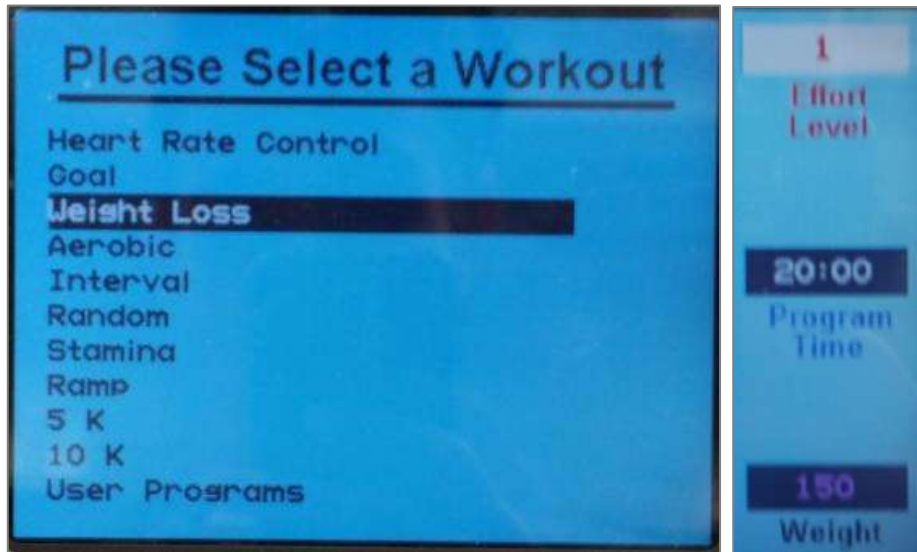

Fig. 76 Fitness Programs menu and data entry – Weight Loss

Program Start

The time is counted down to zero, and then speed and incline will be set to the first segment values. Distance and calories are accumulated. The program profile is shown on the LCD display. The number keys, CLEAR key, and ENTER key are now deactivated.

Usable Variables

While the program is running the user can change the incline using the UP/DOWN incline keys, and the speed using the FAST/SLOW speed keys. The user can interrupt the training at any time by pressing the PAUSE key. The status of the selected program lights up to show progress. The signal sounds 3 seconds before the speed and/or incline changes.

Pausing During Training

When the PAUSE key is pressed, the treadmill stops. The following information is shown on the LCD display: "Treadmill Paused. Press PAUSE to resume." The statistics are paused when the PAUSE key is pressed. When the user presses the PAUSE key again, the workout resumes. The CLEAR key is activated during the pause. Pressing the CLEAR key will reset all the treadmill statistics and return the user to the opening screen (the LCD display shows the message "Press 'FAST' for Quick Start or select a program").

Displaying the Statistics

The statistics are displayed at the bottom of the screen throughout training. Here information such as PACE, CALORIES, CALORIES/HR, VERTICAL FEET, and METs can be found.

Program End

When the program is completed, the LCD will read "Program Complete" and the SPEED is then reset to zero.

When the OFF key is pressed, speed and incline reset to zero and the display will then switch off.

Stage

		SPEED DATA																			
		1	2	3	4	5	6	7	8	9	10	11	12	13	14	15	16	17	18	19	20
	1	0.5	0.7	0.9	1.0	1.2	1.2	1.2	1.2	1.2	1.2	1.2	1.2	1.2	1.2	1.2	1.2	1.0	0.9	0.7	0.5
	2	0.9	1.4	1.7	2.0	2.4	2.4	2.4	2.4	2.4	2.4	2.4	2.4	2.4	2.4	2.4	2.4	2.0	1.7	1.4	0.9
	3	1.4	2.1	2.6	3.0	3.6	3.6	3.6	3.6	3.6	3.6	3.6	3.6	3.6	3.6	3.6	3.6	3.0	2.6	2.1	1.4
	4	1.8	2.8	3.4	4.0	4.8	4.8	4.8	4.8	4.8	4.8	4.8	4.8	4.8	4.8	4.8	4.8	4.0	3.4	2.8	1.8
Level	5	2.3	3.5	4.3	5.0	6.0	6.0	6.0	6.0	6.0	6.0	6.0	6.0	6.0	6.0	6.0	6.0	5.0	4.3	3.5	2.3
	6	2.7	4.2	5.1	6.0	7.2	7.2	7.2	7.2	7.2	7.2	7.2	7.2	7.2	7.2	7.2	7.2	6.0	5.1	4.2	2.7
	7	3.2	4.9	6.0	7.0	8.4	8.4	8.4	8.4	8.4	8.4	8.4	8.4	8.4	8.4	8.4	8.4	7.0	6.0	4.9	3.2
	8	3.6	5.6	6.8	8.0	9.6	9.6	9.6	9.6	9.6	9.6	9.6	9.6	9.6	9.6	9.6	9.6	8.0	6.8	5.6	3.6
	9	4.1	6.3	7.7	9.0	10.8	10.8	10.8	10.8	10.8	10.8	10.8	10.8	10.8	10.8	10.8	10.8	9.0	7.7	6.3	4.1
	10	4.5	7.0	8.5	10.0	12.0	12.0	12.0	12.0	12.0	12.0	12.0	12.0	12.0	12.0	12.0	12.0	10.0	8.5	7.0	4.5
	STG	0.0	0.0	1.0	2.0	3.0	3.0	3.0	3.0	3.0	3.0	3.0	3.0	3.0	3.0	3.0	3.0	2.0	1.0	0.0	0.0

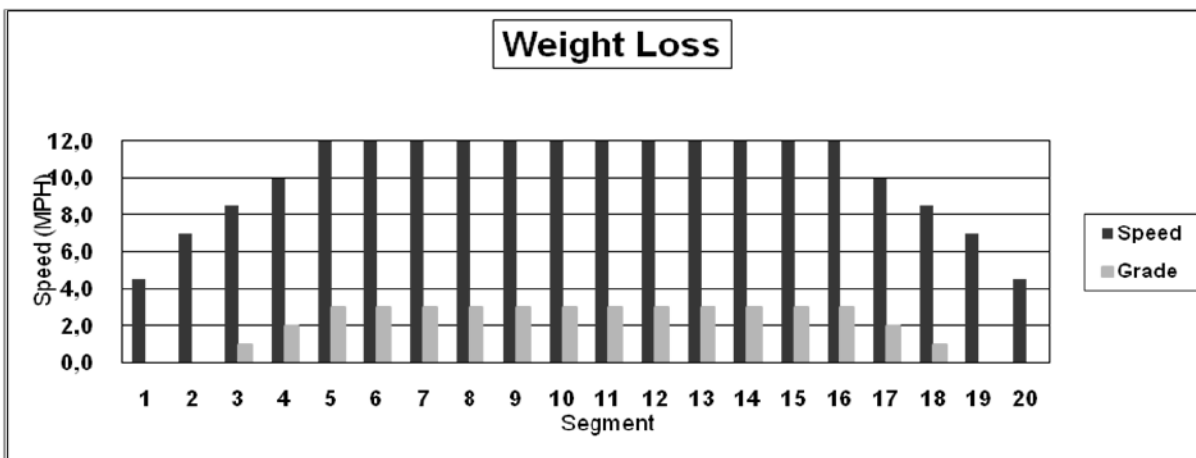

Fig. 77 Fitness Program level outline – Weight Loss

Aerobic Program

This program is designed to improve the user's aerobic condition using high-level training with 3 very intense phases.

Follow the instructions below to begin the Aerobic fitness program.

1. To open the program setup screen, press the FITNESS PROGRAMS button on the left side of the screen. Then use the SCROLL keys to highlight the "AEROBIC" program and press ENTER to select.
2. Once in the program setup screen, use the SCROLL keys to toggle between LEVEL, TIME, and WEIGHT fields. Adjust to the desired values using either the FAST/SLOW keys or the number pad. Once desired settings are displayed, press ENTER to begin.

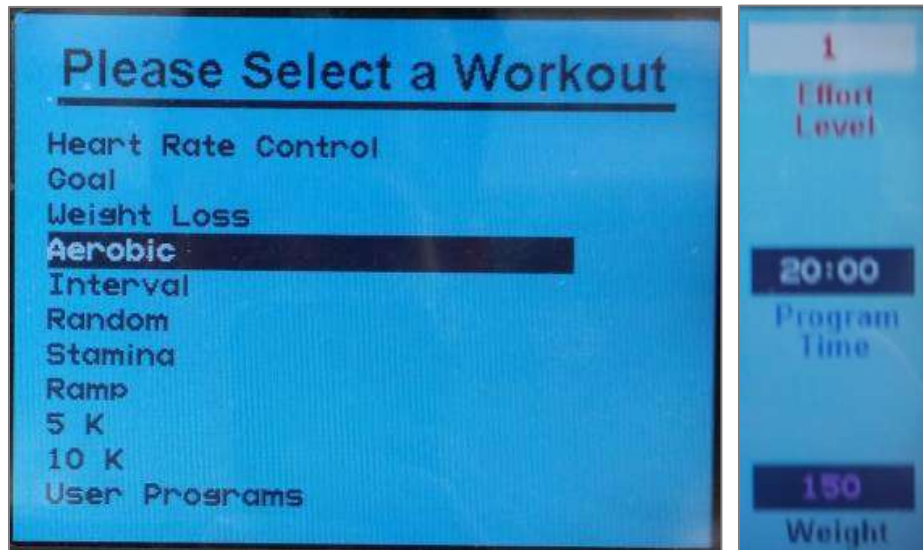

Fig. 78 Fitness Programs menu and data entry – Aerobic

Program Start

The time is counted down to zero, and then speed and incline will be set to the first segment values. Distance and calories are accumulated. The program profile is shown on the LCD display. The number keys, CLEAR key, and ENTER key are now deactivated.

Usable Variables

While the program is running the user can change the incline using the UP/DOWN incline keys, and the speed using the FAST/SLOW speed keys. The user can interrupt the training at any time by pressing the PAUSE key. The status of the selected program lights up to show progress. The signal sounds 3 seconds before the speed and/or incline changes.

Pausing During Training

When the PAUSE key is pressed, the treadmill stops. The following information is shown on the LCD display: "Treadmill Paused. Press PAUSE to resume." The statistics are paused when the PAUSE key is pressed. When the user presses the PAUSE key again, the workout resumes. The CLEAR key is activated during the pause. Pressing the CLEAR key will reset all the treadmill statistics and return the user to the opening screen (the LCD display shows the message "Press 'FAST' for Quick Start or select a program").

Displaying the Statistics

The statistics are displayed at the bottom of the screen throughout training. Here information such as PACE, CALORIES, CALORIES/HR, VERTICAL FEET, and METs can be found.

Program End

When the program is completed, the LCD will read "Program Complete" and the SPEED is then reset to zero.

When the OFF key is pressed, speed and incline reset to zero and the display will then switch off.

Stage

		SPEED DATA																			
		1	2	3	4	5	6	7	8	9	10	11	12	13	14	15	16	17	18	19	20
	1	0.5	0.6	0.8	1.0	1.2	1.0	0.8	0.6	0.8	1.0	1.2	0.8	0.6	0.8	1.0	1.2	1.0	0.8	0.6	0.5
	2	0.9	1.2	1.6	2.0	2.4	2.0	1.6	1.1	1.6	2.0	2.4	1.6	1.1	1.6	2.0	2.4	2.0	1.6	1.2	0.9
	3	1.4	1.8	2.4	3.0	3.6	3.0	2.4	1.7	2.4	3.0	3.6	2.4	1.7	2.4	3.0	3.6	3.0	2.4	1.8	1.4
	4	1.8	2.4	3.2	4.0	4.8	4.0	3.2	2.2	3.2	4.0	4.8	3.2	2.2	3.2	4.0	4.8	4.0	3.2	2.4	1.8
Level	5	2.3	3.0	4.0	5.0	6.0	5.0	4.0	2.8	4.0	5.0	6.0	4.0	2.8	4.0	5.0	6.0	5.0	4.0	3.0	2.3
	6	2.7	3.6	4.8	6.0	7.2	6.0	4.8	3.3	4.8	6.0	7.2	4.8	3.3	4.8	6.0	7.2	6.0	4.8	3.6	2.7
	7	3.2	4.2	5.6	7.0	8.4	7.0	5.6	3.9	5.6	7.0	8.4	5.6	3.9	5.6	7.0	8.4	7.0	5.6	4.2	3.2
	8	3.6	4.8	6.4	8.0	9.6	8.0	6.4	4.4	6.4	8.0	9.6	6.4	4.4	6.4	8.0	9.6	8.0	6.4	4.8	3.6
	9	4.1	5.4	7.2	9.0	10.8	9.0	7.2	5.0	7.2	9.0	10.8	7.2	5.0	7.2	9.0	10.8	9.0	7.2	5.4	4.1
	10	4.5	6.0	8.0	10.0	12.0	10.0	8.0	5.5	8.0	10.0	12.0	8.0	5.5	8.0	10.0	12.0	10.0	8.0	6.0	4.5
	STG	0.0	0.0	1.0	1.0	1.0	1.0	2.0	2.0	2.0	1.0	1.0	2.0	2.0	2.0	1.0	1.0	1.0	1.0	0.0	0.0

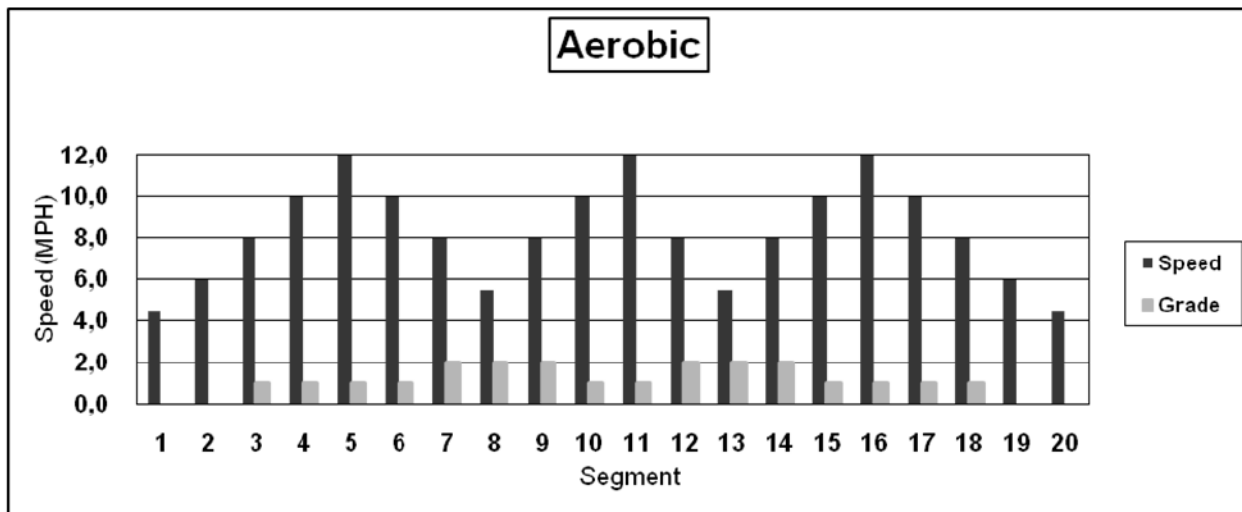

Fig. 79 Fitness Program level outline – Aerobic

Aerobic Program Follow the instructions below to set up and begin the Interval fitness program.

1. To open the program setup screen, first press the "FITNESS PROGRAMS" button on the left side of the screen. Once there, use the SCROLL keys to highlight the "Interval" program and then press ENTER.
2. Once in the program setup screen, use the SCROLL keys to toggle between the various fields. Adjust to the desired value in each field using either the FAST/SLOW keys or the number pad. Speed and Incline must be entered for each interval as well as the desired overall time and the user's weight. Once all fields show your desired settings, press ENTER to begin.

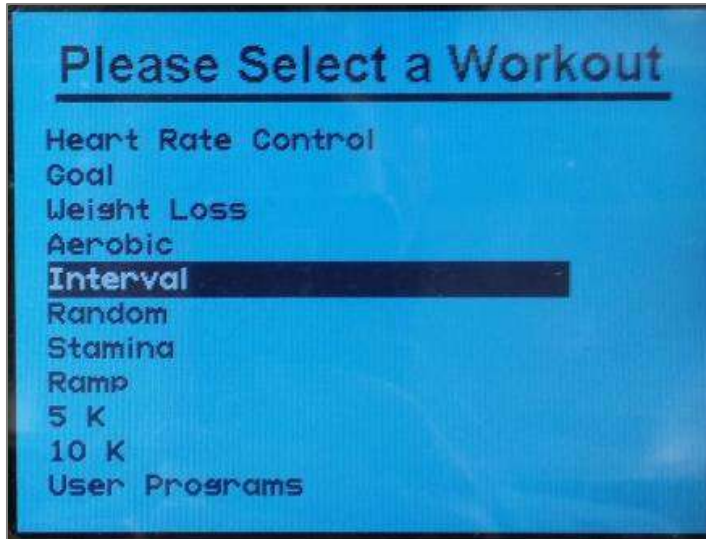

Fig. 80 Fitness Programs menu – Interval

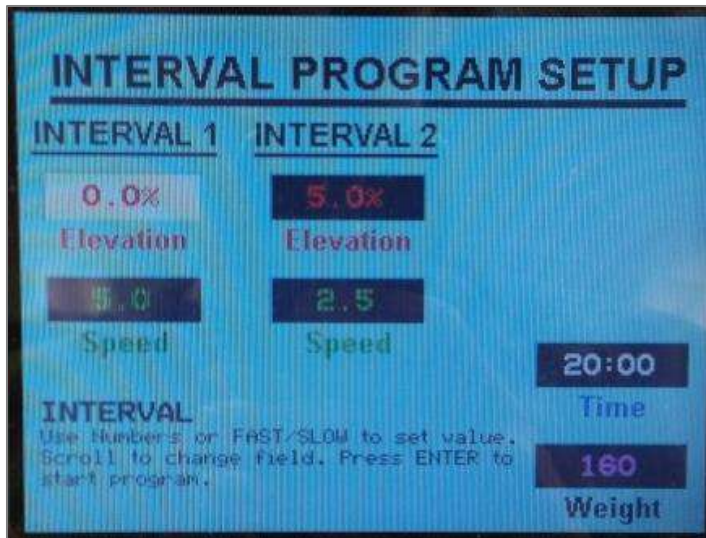

Fig. 81 Data entry – Interval



Fig. 82 Live data screen – Interval

- Usable Variables** During any specific interval, the SPEED and INCLINE may be adjusted manually. Regardless of the SPEED and INCLINE changes made by the user during an interval, the SCROLL keys still revert to the opposite interval settings as normal.
- Displaying the Statistics** The statistics are displayed at the bottom of the screen throughout training. Here information such as PACE, CALORIES, CALORIES/HR, VERTICAL FEET, and METs can be found. During an Interval Fitness Program, 3 diagrams will be shown: the INCLINE (red) will be shown on top, the SPEED (green) is shown in the middle, and the user's heart rate (yellow) is shown at the bottom. Use the SCROLL keys to alternate between the two interval settings established in step 2.
- Program End** When the program is completed, the LCD will read "Program Complete" and the SPEED is then reset to zero.

When the OFF key is pressed, speed and incline reset to zero and the display will then switch off.

Random Program

This is an interesting and challenging training program that selects varying speed and incline changes at random intervals.

Follow the instructions below to begin the Random fitness program.

1. To open the program setup screen, first press the "FITNESS PROGRAMS" button on the left side of the screen. Once there, use the SCROLL keys to highlight the "Random" program and then press ENTER.

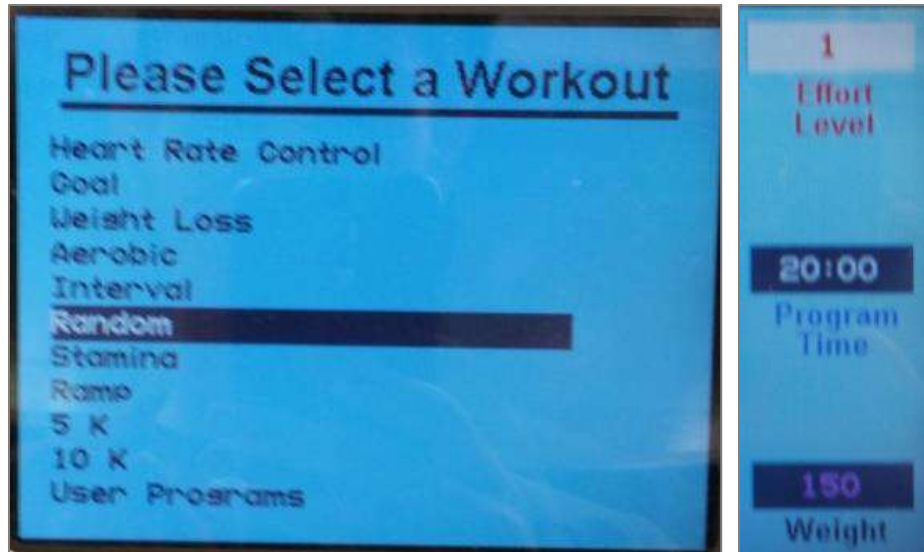

Fig. 83 Fitness Programs menu and data entry – Random

2. Once in the program setup screen, use the SCROLL keys to toggle between the LEVEL, TIME, and WEIGHT fields. Adjust to the desired value in each of these fields using either the FAST/SLOW keys or the number pad. Once all fields show your desired settings, press ENTER to begin.

Program Start

The time is counted down to zero, and then speed and incline will be set to the first segment values. Distance and calories are accumulated. The program profile is shown on the LCD display. The number keys, CLEAR key, and ENTER key are now deactivated.

Usable Variables

While the program is running the user can change the incline using the UP/DOWN incline keys, and the speed using the FAST/SLOW speed keys. The user can interrupt the training at any time by pressing the PAUSE key. The status of the selected program lights up to show progress. The signal sounds 3 seconds before the speed and/or incline changes.

Pausing During Training

When the PAUSE key is pressed, the treadmill stops. The following information is shown on the LCD display: "Treadmill Paused. Press PAUSE to resume." The statistics are paused when the PAUSE key is pressed. When the user presses the PAUSE key again, the workout resumes. The CLEAR key is activated during the pause. Pressing the CLEAR key will reset all the treadmill statistics and return the user to the opening screen (the LCD display shows the message "Press 'FAST' for Quick Start or select a program").

Displaying the Statistics

The statistics are displayed at the bottom of the screen throughout training. Here information such as PACE, CALORIES, CALORIES/HR, VERTICAL FEET, and METs can be found.

Program End

When the program is completed, the LCD will read "Program Complete" and the SPEED is then reset to zero.

When the OFF key is pressed, speed and incline reset to zero and the display will then switch off.

Stage

	SPEED DATA																				
	1	2	3	4	5	6	7	8	9	10	11	12	13	14	15	16	17	18	19	20	
1	0.4	0.5	0.8	0.8	0.6	0.9	1.1	0.6	0.8	0.6	1.0	0.7	1.2	0.8	0.6	0.6	0.8	1.1	0.6	0.5	
2	0.8	1.0	1.6	1.5	1.2	1.7	2.1	1.1	1.6	1.1	2.0	1.4	2.4	1.6	1.2	1.1	1.6	2.1	1.2	0.9	
3	1.2	1.5	2.4	2.3	1.8	2.6	3.2	1.7	2.4	1.7	3.0	2.1	3.6	2.4	1.8	1.7	2.4	3.2	1.8	1.4	
4	1.6	2.0	3.2	3.0	2.4	3.4	4.2	2.2	3.2	2.2	4.0	2.8	4.8	3.2	2.4	2.2	3.2	4.2	2.4	1.8	
Level	5	2.0	2.5	4.0	3.8	3.0	4.3	5.3	2.8	4.0	2.8	5.0	3.5	6.0	4.0	3.0	2.8	4.0	5.3	3.0	2.3
	6	2.4	3.0	4.8	4.5	3.6	5.1	6.3	3.3	4.8	3.3	6.0	4.2	7.2	4.8	3.6	3.3	4.8	6.3	3.6	2.7
	7	2.8	3.5	5.6	5.3	4.2	6.0	7.4	3.9	5.6	3.9	7.0	4.9	8.4	5.6	4.2	3.9	5.6	7.4	4.2	3.2
	8	3.2	4.0	6.4	6.0	4.8	6.8	8.4	4.4	6.4	4.4	8.0	5.6	9.6	6.4	4.8	4.4	6.4	8.4	4.8	3.6
	9	3.6	4.5	7.2	6.8	5.4	7.7	9.5	5.0	7.2	5.0	9.0	6.3	10.8	7.2	5.4	5.0	7.2	9.5	5.4	4.1
	10	4.0	5.0	8.0	7.5	6.0	8.5	10.5	5.5	8.0	5.5	10.0	7.0	12.0	8.0	6.0	5.5	8.0	10.5	6.0	4.5
STG	0.0	1.0	1.0	2.0	2.0	0.0	0.0	1.0	1.0	1.0	0.0	0.0	0.0	1.0	2.0	2.0	1.0	1.0	0.0	0.0	

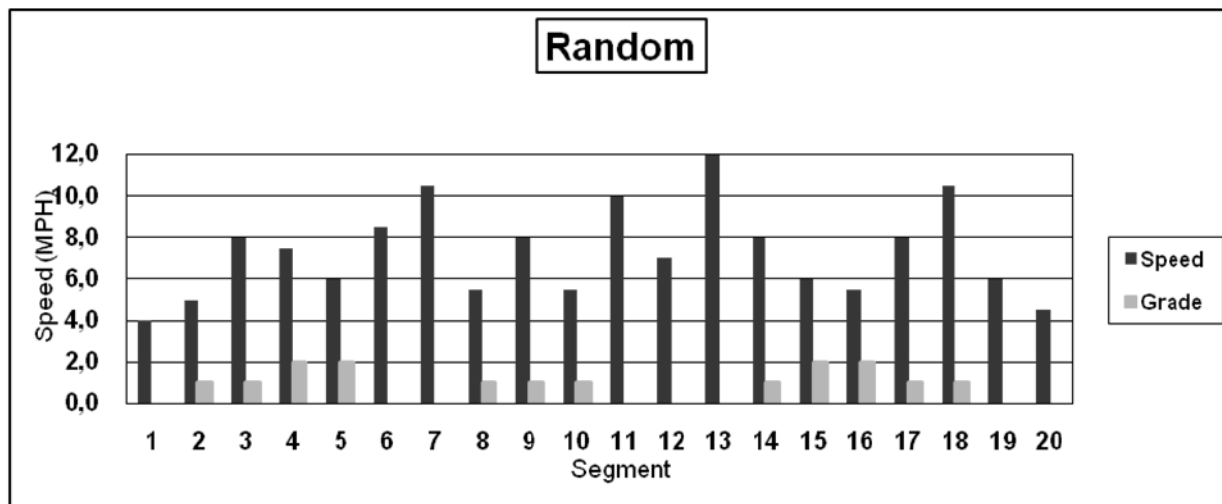

Fig. 84 Fitness Program level outline – Random

Stamina Program A program with increasing load and two different phases, each with a peak load, this program builds endurance.

Follow the instructions below to begin the Stamina fitness program.

1. To open the program setup screen, first press the "FITNESS PROGRAMS" button on the left side of the screen. Once there, use the SCROLL keys to highlight the "Stamina" program and then press ENTER.

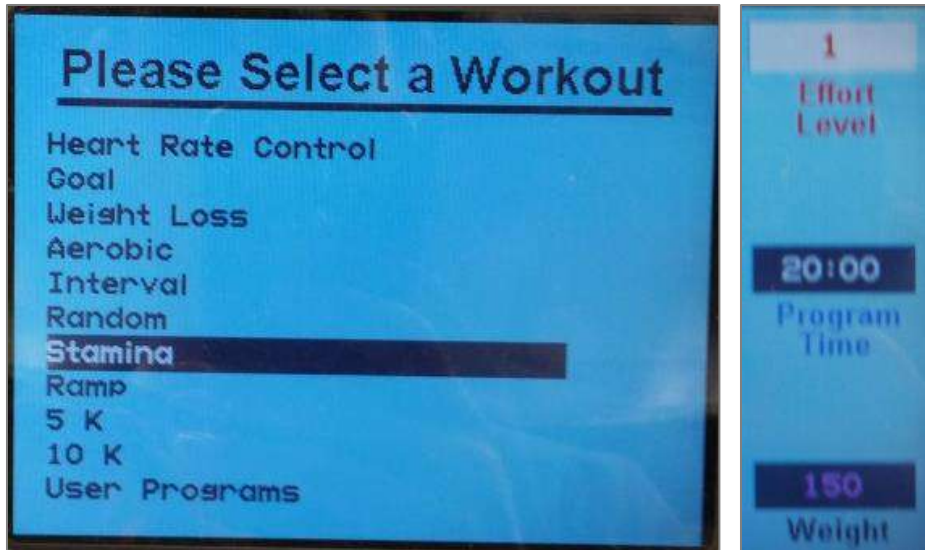

Fig. 85 Fitness Programs menu and data entry – Stamina

2. Once in the program setup screen, use the SCROLL keys to toggle between the LEVEL, TIME, and WEIGHT fields. Adjust to the desired value in each of these fields using either the FAST/SLOW keys or the number pad. Once all fields show your desired settings, press ENTER to begin.

Program Start The time is counted down to zero, and then speed and incline will be set to the first segment values. Distance and calories are accumulated. The program profile is shown on the LCD display. The number keys, CLEAR key, and ENTER key are now deactivated.

Usable Variables While the program is running the user can change the incline using the UP/DOWN incline keys, and the speed using the FAST/SLOW speed keys. The user can interrupt the training at any time by pressing the PAUSE key. The status of the selected program lights up to show progress. The signal sounds 3 seconds before the speed and/or incline changes.

Pausing During Training When the PAUSE key is pressed, the treadmill stops. The following information is shown on the LCD display: "Treadmill Paused. Press PAUSE to resume." The statistics are paused when the PAUSE key is pressed. When the user presses the PAUSE key again, the workout resumes. The CLEAR key is activated during the pause. Pressing the CLEAR key will reset all the treadmill statistics and return the user to the opening screen (the LCD display shows the message "Press 'FAST' for Quick Start or select a program").

Displaying the Statistics The statistics are displayed at the bottom of the screen throughout training. Here information such as PACE, CALORIES, CALORIES/HR, VERTICAL FEET, and METs can be found.

Program End When the program is completed, the LCD will read "Program Complete" and the SPEED is then reset to zero.

When the OFF key is pressed, speed and incline reset to zero and the display will then switch off.

Stage

	SPEED DATA																			
	1	2	3	4	5	6	7	8	9	10	11	12	13	14	15	16	17	18	19	20
	0.5	0.5	0.6	0.7	0.8	0.9	1.0	1.1	1.2	0.5	0.5	0.6	0.7	0.8	0.9	1.0	1.1	1.2	0.5	0.5
	0.9	1.0	1.2	1.4	1.6	1.8	2.0	2.2	2.4	0.9	1.0	1.2	1.4	1.6	1.8	2.0	2.2	2.4	0.9	0.9
	1.4	1.5	1.8	2.1	2.4	2.7	3.0	3.3	3.6	1.4	1.5	1.8	2.1	2.4	2.7	3.0	3.3	3.6	1.4	1.4
	1.8	2.0	2.4	2.8	3.2	3.6	4.0	4.4	4.8	1.8	2.0	2.4	2.8	3.2	3.6	4.0	4.4	4.8	1.8	1.8
Level	2.3	2.5	3.0	3.5	4.0	4.5	5.0	5.5	6.0	2.3	2.5	3.0	3.5	4.0	4.5	5.0	5.5	6.0	2.3	2.3
	2.7	3.0	3.6	4.2	4.8	5.4	6.0	6.6	7.2	2.7	3.0	3.6	4.2	4.8	5.4	6.0	6.6	7.2	2.7	2.7
	3.2	3.5	4.2	4.9	5.6	6.3	7.0	7.7	8.4	3.2	3.5	4.2	4.9	5.6	6.3	7.0	7.7	8.4	3.2	3.2
	3.6	4.0	4.8	5.6	6.4	7.2	8.0	8.8	9.6	3.6	4.0	4.8	5.6	6.4	7.2	8.0	8.8	9.6	3.6	3.6
	4.1	4.5	5.4	6.3	7.2	8.1	9.0	9.9	10.8	4.1	4.5	5.4	6.3	7.2	8.1	9.0	9.9	10.8	4.1	4.1
	4.5	5.0	6.0	7.0	8.0	9.0	10.0	11.0	12.0	4.5	5.0	6.0	7.0	8.0	9.0	10.0	11.0	12.0	4.5	4.5
STG	0.0	1.0	1.0	2.0	2.0	2.0	2.0	2.0	2.0	2.0	2.0	2.0	2.0	2.0	2.0	2.0	2.0	1.0	1.0	0.0

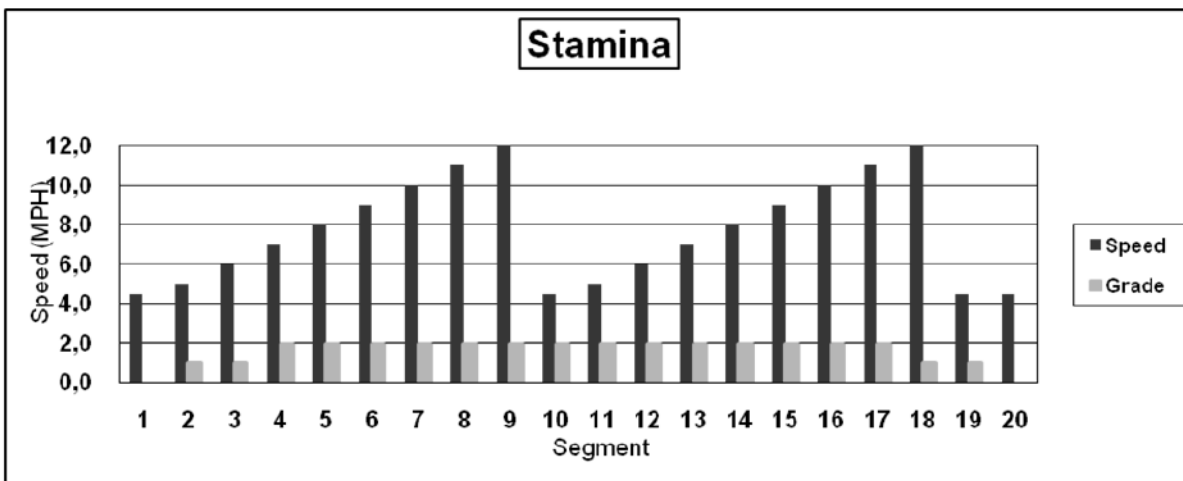

Fig. 86 Fitness Program level outline – Stamina

Ramp Program The program has a slowly increasing load. Here you will gradually increase to the top speed for the selected intensity level before a final cool-down phase.

Follow the instructions below to begin the Ramp fitness program.

1. To open the program setup screen, first press the "FITNESS PROGRAMS" button on the left side of the screen. Once there, use the SCROLL keys to highlight the "Ramp" program and then press ENTER.

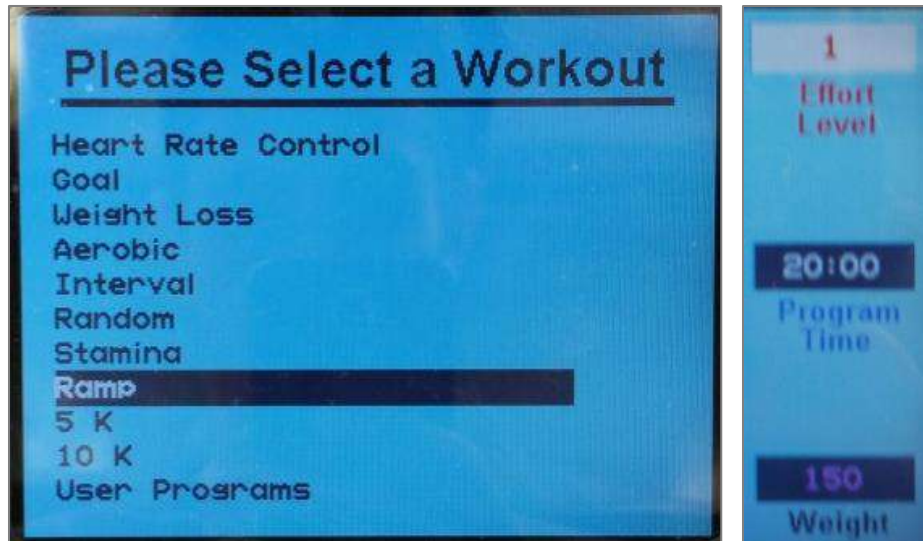

Fig. 87 Fitness Programs menu and data entry – Ramp

2. Once in the program setup screen, use the SCROLL keys to toggle between the LEVEL, TIME, and WEIGHT fields. Adjust to the desired value in each of these fields using either the FAST/SLOW keys or the number pad. Once all fields show your desired settings, press ENTER to begin.

Program Start The time is counted down to zero, and then speed and incline will be set to the first segment values. Distance and calories are accumulated. The program profile is shown on the LCD display. The number keys, CLEAR key, and ENTER key are now deactivated.

Usable Variables While the program is running the user can change the incline using the UP/DOWN incline keys, and the speed using the FAST/SLOW speed keys. The user can interrupt the training at any time by pressing the PAUSE key. The status of the selected program lights up to show progress. The signal sounds 3 seconds before the speed and/or incline changes.

Pausing During Training When the PAUSE key is pressed, the treadmill stops. The following information is shown on the LCD display: "Treadmill Paused. Press PAUSE to resume." The statistics are paused when the PAUSE key is pressed. When the user presses the PAUSE key again, the workout resumes. The CLEAR key is activated during the pause. Pressing the CLEAR key will reset all the treadmill statistics and return the user to the opening screen (the LCD display shows the message "Press 'FAST' for Quick Start or select a program").

Displaying the Statistics The statistics are displayed at the bottom of the screen throughout training. Here information such as PACE, CALORIES, CALORIES/HR, VERTICAL FEET, and METs can be found.

Program End When the program is completed, the LCD will read "Program Complete" and the SPEED is then reset to zero.

When the OFF key is pressed, speed and incline reset to zero and the display will then switch off.

Stage

		SPEED DATA																			
		1	2	3	4	5	6	7	8	9	10	11	12	13	14	15	16	17	18	19	20
	1	0.5	0.5	0.5	0.6	0.6	0.7	0.7	0.8	0.8	0.9	0.9	1.0	1.0	1.1	1.1	1.2	1.2	0.5	0.5	0.5
	2	0.9	0.9	1.0	1.1	1.2	1.3	1.4	1.5	1.6	1.7	1.8	1.9	2.0	2.1	2.2	2.3	2.4	0.9	0.9	0.9
	3	1.4	1.4	1.5	1.7	1.8	2.0	2.1	2.3	2.4	2.6	2.7	2.9	3.0	3.2	3.3	3.5	3.6	1.4	1.4	1.4
	4	1.8	1.8	2.0	2.2	2.4	2.6	2.8	3.0	3.2	3.4	3.6	3.8	4.0	4.2	4.4	4.6	4.8	1.8	1.8	1.8
Level	5	2.3	2.3	2.5	2.8	3.0	3.3	3.5	3.8	4.0	4.3	4.5	4.8	5.0	5.3	5.5	5.8	6.0	2.3	2.3	2.3
	6	2.7	2.7	3.0	3.3	3.6	3.9	4.2	4.5	4.8	5.1	5.4	5.7	6.0	6.3	6.6	6.9	7.2	2.7	2.7	2.7
	7	3.2	3.2	3.5	3.9	4.2	4.6	4.9	5.3	5.6	6.0	6.3	6.7	7.0	7.4	7.7	8.1	8.4	3.2	3.2	3.2
	8	3.6	3.6	4.0	4.4	4.8	5.2	5.6	6.0	6.4	6.8	7.2	7.6	8.0	8.4	8.8	9.2	9.5	3.6	3.6	3.6
	9	4.1	4.1	4.5	5.0	5.4	5.9	6.3	6.8	7.2	7.7	8.1	8.6	9.0	9.5	9.9	10.4	10.8	4.1	4.1	4.1
	10	4.5	4.5	5.0	5.5	6.0	6.5	7.0	7.5	8.0	8.5	9.0	9.5	10.0	10.5	11.0	11.5	12.0	4.5	4.5	4.5
	GRD	0.0	1.0	2.0	2.0	2.0	1.0	1.0	1.0	1.0	1.0	1.0	1.0	1.0	1.0	1.0	1.0	0.0	0.0	0.0	

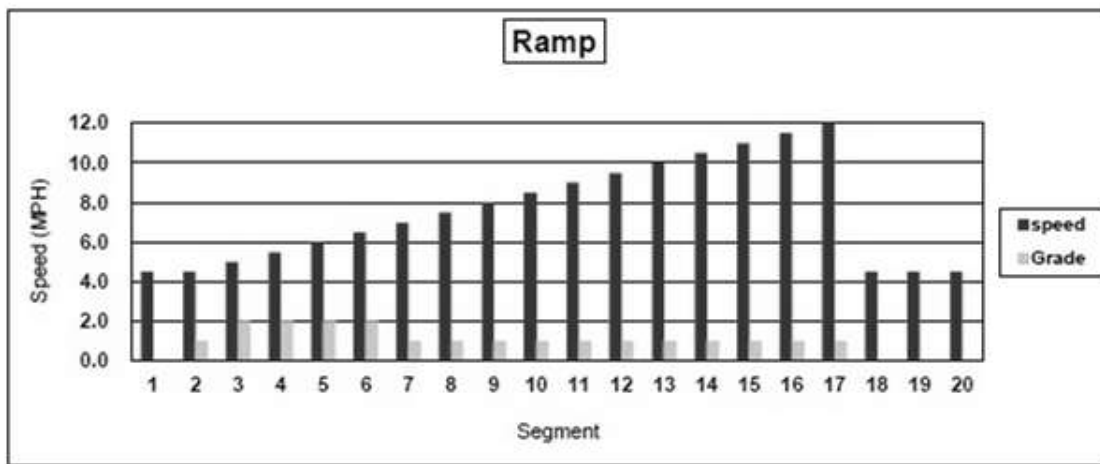

Fig. 88 Fitness Program Level Outline – Ramp

5K Program This program is a distance-based program with a simulated 5-kilometer (3.1 mile) race track. The user determines the running speed by selecting an intensity level.

Follow the instructions below to begin the 5K fitness program.

1. To open the program setup screen, first press the "FITNESS PROGRAMS" button on the left side of the screen. Once there, use the SCROLL keys to highlight the "5K" program and then press ENTER.

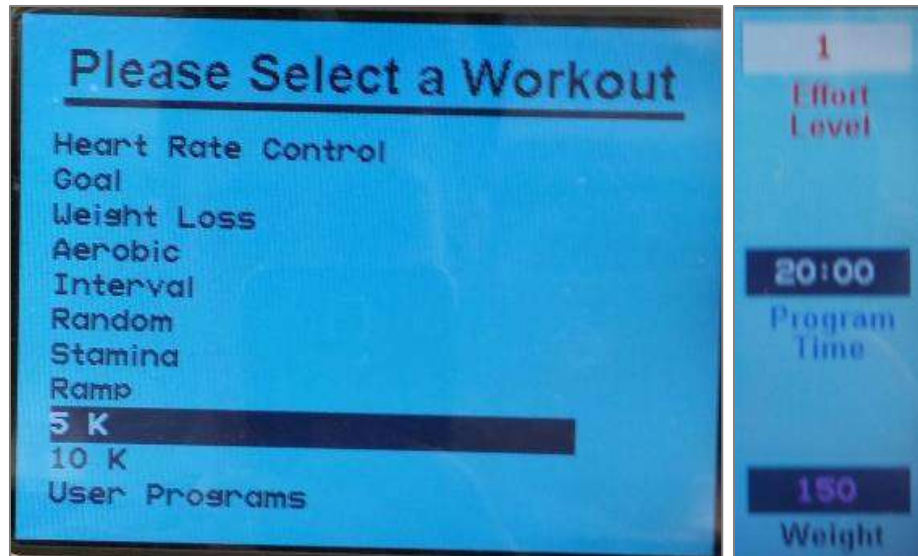

Fig. 89 Fitness Programs menu and data entry – 5K

2. Once in the program setup screen, use the SCROLL keys to toggle between the LEVEL, TIME, and WEIGHT fields. Adjust to the desired value in each of these fields using either the FAST/SLOW keys or the number pad. Once all fields show your desired settings, press ENTER to begin.

Program Start The time is counted down to zero, and then speed and incline will be set to the first segment values. Distance and calories are accumulated. The program profile is shown on the LCD display. The number keys, CLEAR key, and ENTER key are now deactivated.

Usable Variables While the program is running the user can change the incline using the UP/DOWN incline keys, and the speed using the FAST/SLOW speed keys. The user can interrupt the training at any time by pressing the PAUSE key. The status of the selected program lights up to show progress. The signal sounds 3 seconds before the speed and/or incline changes.

Pausing During Training When the PAUSE key is pressed, the treadmill stops. The following information is shown on the LCD display: "Treadmill Paused. Press PAUSE to resume." The statistics are paused when the PAUSE key is pressed. When the user presses the PAUSE key again, the workout resumes. The CLEAR key is activated during the pause. Pressing the CLEAR key will reset all the treadmill statistics and return the user to the opening screen (the LCD display shows the message "Press 'FAST' for Quick Start or select a program").

Displaying the Statistics The statistics are displayed at the bottom of the screen throughout training. Here information such as PACE, CALORIES, CALORIES/HR, VERTICAL FEET, and METs can be found.

Program End When the program is completed, the LCD will read "Program Complete" and the SPEED is then reset to zero.

When the OFF key is pressed, speed and incline reset to zero and the display will then switch off.

Stage

	SPEED DATA																			
	1	2	3	4	5	6	7	8	9	10	11	12	13	14	15	16	17	18	19	20
1	0.5	0.5	1.0	1.0	1.0	1.0	1.0	1.0	1.0	1.0	1.0	1.0	1.0	1.0	1.0	1.0	1.0	1.0	0.5	0.5
2	0.9	0.9	2.0	2.0	2.0	2.0	2.0	2.0	2.0	2.0	2.0	2.0	2.0	2.0	2.0	2.0	2.0	2.0	0.9	0.9
3	1.4	1.4	3.0	3.0	3.0	3.0	3.0	3.0	3.0	3.0	3.0	3.0	3.0	3.0	3.0	3.0	3.0	3.0	1.4	1.4
4	1.8	1.8	4.0	4.0	4.0	4.0	4.0	4.0	4.0	4.0	4.0	4.0	4.0	4.0	4.0	4.0	4.0	4.0	1.8	1.8
Level	5	2.3	2.3	5.0	5.0	5.0	5.0	5.0	5.0	5.0	5.0	5.0	5.0	5.0	5.0	5.0	5.0	5.0	2.3	2.3
	6	2.7	2.7	6.0	6.0	6.0	6.0	6.0	6.0	6.0	6.0	6.0	6.0	6.0	6.0	6.0	6.0	6.0	2.7	2.7
	7	3.2	3.2	7.0	7.0	7.0	7.0	7.0	7.0	7.0	7.0	7.0	7.0	7.0	7.0	7.0	7.0	7.0	3.2	3.2
	8	3.6	3.6	8.0	8.0	8.0	8.0	8.0	8.0	8.0	8.0	8.0	8.0	8.0	8.0	8.0	8.0	8.0	3.6	3.6
	9	4.1	4.1	9.0	9.0	9.0	9.0	9.0	9.0	9.0	9.0	9.0	9.0	9.0	9.0	9.0	9.0	9.0	4.1	4.1
	10	4.5	4.5	10.0	10.0	10.0	10.0	10.0	10.0	10.0	10.0	10.0	10.0	10.0	10.0	10.0	10.0	10.0	4.5	4.5

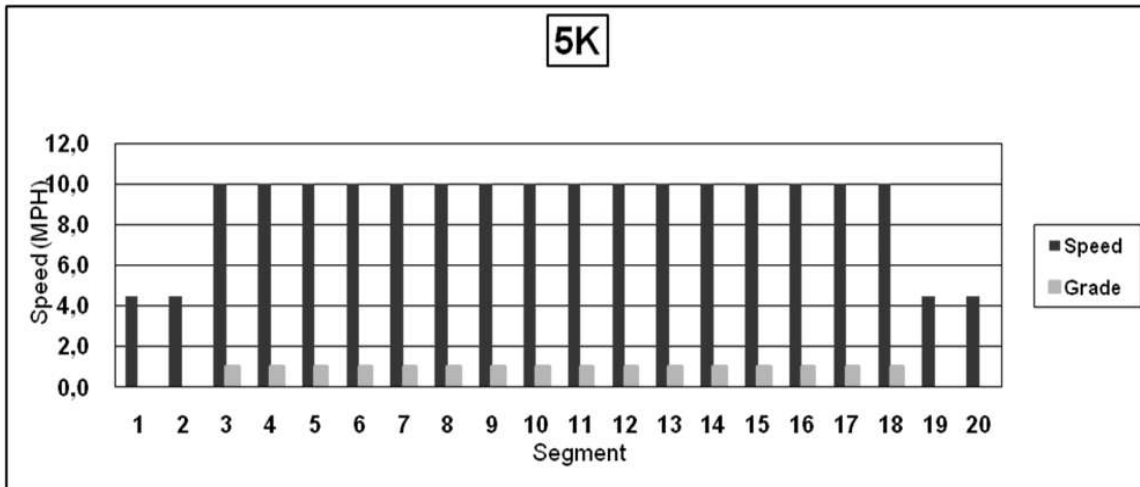

Fig. 90 Fitness Program Level Outline, 5K

10K Program This program is a distance-based program with which a 10-kilometer (6.2 mile) run can be simulated, allowing the user to build endurance.

Follow the instructions below to begin the 10K fitness program.

1. To open the program setup screen, first press the "FITNESS PROGRAMS" button on the left side of the screen. Once there, use the SCROLL keys to highlight the "10K" program and then press ENTER.

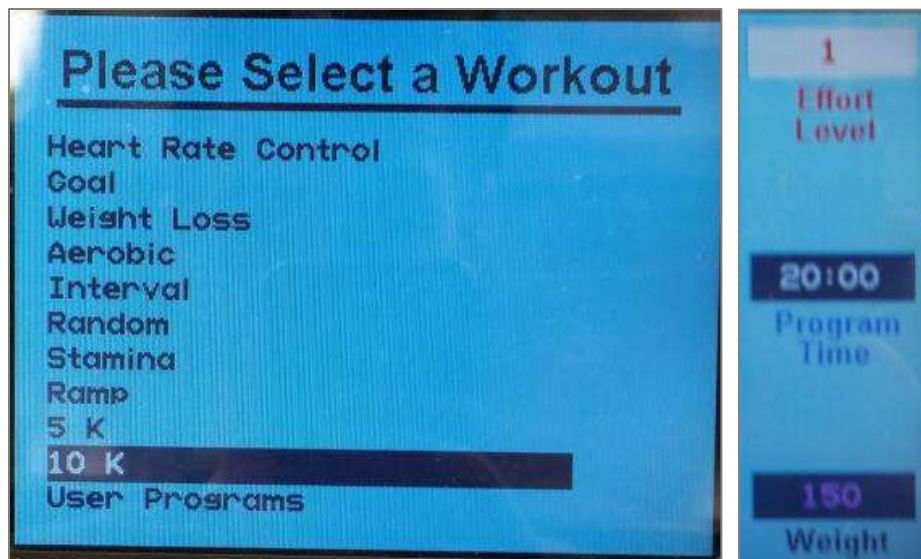

Fig. 91 Fitness Programs menu and data entry – 10K

2. Once in the program setup screen, use the SCROLL keys to toggle between the LEVEL, TIME, and WEIGHT fields. Adjust to the desired value in each of these fields using either the FAST/SLOW keys or the number pad. Once all fields show your desired settings, press ENTER to begin.

Program Start

The time is counted down to zero, and then speed and incline will be set to the first segment values. Distance and calories are accumulated. The program profile is shown on the LCD display. The number keys, CLEAR key, and ENTER key are now deactivated.

Usable Variables

While the program is running the user can change the incline using the UP/DOWN incline keys, and the speed using the FAST/SLOW speed keys. The user can interrupt the training at any time by pressing the PAUSE key. The status of the selected program lights up to show progress. The signal sounds 3 seconds before the speed and/or incline changes.

Pausing During Training

When the PAUSE key is pressed, the treadmill stops. The following information is shown on the LCD display: "Treadmill Paused. Press PAUSE to resume." The statistics are paused when the PAUSE key is pressed. When the user presses the PAUSE key again, the workout resumes. The CLEAR key is activated during the pause. Pressing the CLEAR key will reset all the treadmill statistics and return the user to the opening screen (the LCD display shows the message "Press 'FAST' for Quick Start or select a program").

Displaying the Statistics

The statistics are displayed at the bottom of the screen throughout training. Here information such as PACE, CALORIES, CALORIES/HR, VERTICAL FEET, and METs can be found.

Program End

When the program is completed, the LCD will read "Program Complete" and the SPEED is then reset to zero.

When the OFF key is pressed, speed and incline reset to zero and the display will then switch off.

Stage

		SPEED DATA																			
		1	2	3	4	5	6	7	8	9	10	11	12	13	14	15	16	17	18	19	20
	1	0.5	0.5	1.2	1.2	1.2	1.2	1.2	1.2	1.2	1.2	1.2	1.2	1.2	1.2	1.2	1.2	1.2	1.2	0.5	0.5
	2	0.9	0.9	2.4	2.4	2.4	2.4	2.4	2.4	2.4	2.4	2.4	2.4	2.4	2.4	2.4	2.4	2.4	2.4	0.9	0.9
	3	1.4	1.4	3.6	3.6	3.6	3.6	3.6	3.6	3.6	3.6	3.6	3.6	3.6	3.6	3.6	3.6	3.6	3.6	1.4	1.4
	4	1.8	1.8	4.8	4.8	4.8	4.8	4.8	4.8	4.8	4.8	4.8	4.8	4.8	4.8	4.8	4.8	4.8	4.8	1.8	1.8
Level	5	2.3	2.3	6.0	6.0	6.0	6.0	6.0	6.0	6.0	6.0	6.0	6.0	6.0	6.0	6.0	6.0	6.0	6.0	2.3	2.3
	6	2.7	2.7	7.2	7.2	7.2	7.2	7.2	7.2	7.2	7.2	7.2	7.2	7.2	7.2	7.2	7.2	7.2	7.2	2.7	2.7
	7	3.2	3.2	8.4	8.4	8.4	8.4	8.4	8.4	8.4	8.4	8.4	8.4	8.4	8.4	8.4	8.4	8.4	8.4	3.2	3.2
	8	3.6	3.6	9.6	9.6	9.6	9.6	9.6	9.6	9.6	9.6	9.6	9.6	9.6	9.6	9.6	9.6	9.6	9.6	3.6	3.6
	9	4.1	4.1	10.8	10.8	10.8	10.8	10.8	10.8	10.8	10.8	10.8	10.8	10.8	10.8	10.8	10.8	10.8	10.8	4.1	4.1
	10	4.5	4.5	12.0	12.0	12.0	12.0	12.0	12.0	12.0	12.0	12.0	12.0	12.0	12.0	12.0	12.0	12.0	12.0	4.5	4.5
	STG	0.0	0.0	0.0	0.0	0.0	0.0	0.0	0.0	0.0	0.0	0.0	0.0	0.0	0.0	0.0	0.0	0.0	0.0	0.0	0.0

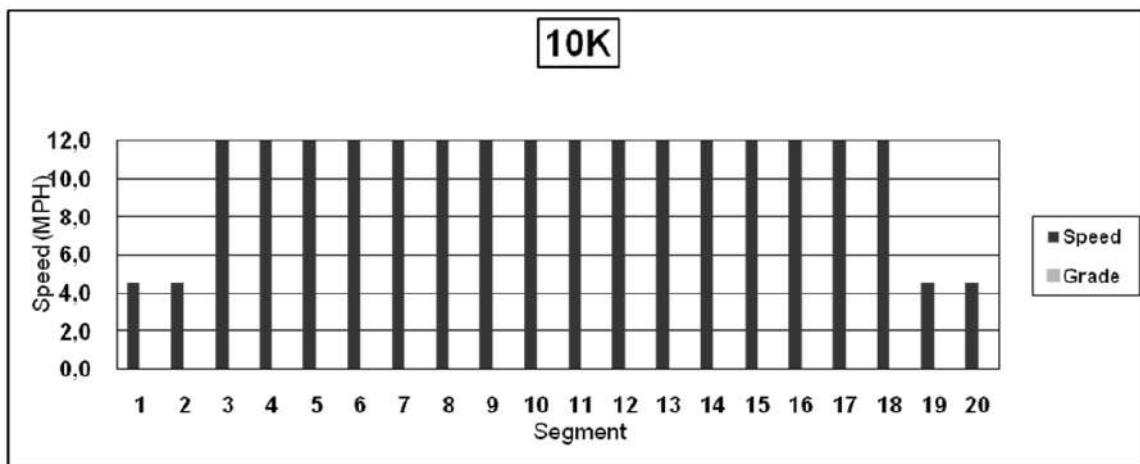

Fig. 92 Fitness Program Level Outline – 10K

7.8.6 User Programs

Personal Trainer Displays come with the feature that allows the user to customize a personal workout and have it remain on that particular treadmill for future workouts.

To customize a user program:

1. Turn on the treadmill with the ON button.
2. Select FITNESS PROGRAMS button.
3. Scroll down through the list of workouts using the up/down scroll buttons to find "USER PROGRAMS". Press ENTER to select.

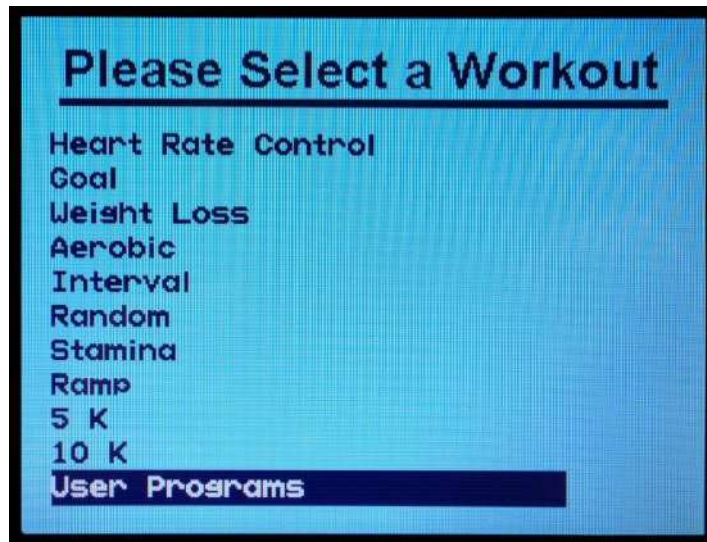

Fig. 93 Fitness programs screen

Edit Program Name

All programs can be renamed directly on the screen (up to 24 characters) to help differentiate between customized programs.

1. Press and hold PAUSE button for 5 seconds to activate text editing of the workout you plan to customize
 - Use the UP/DOWN incline buttons to scroll from left to right to change text.
 - Use the FAST/SLOW speed buttons to scroll through the alphabet.
2. Once the program name has been edited, press ENTER to run the program.

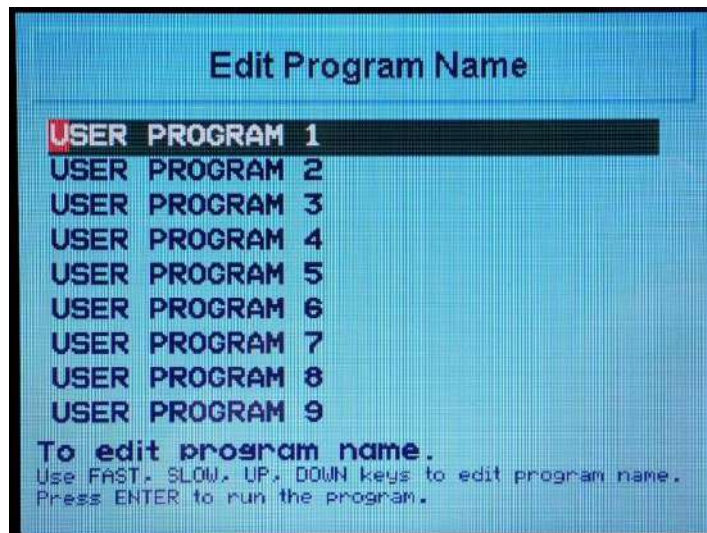

Fig. 94 Edit fitness program name screen

Edit Program

Existing programs can be modified and personalized programs can be written, reset, or erased.

1. Press and hold CLEAR button for 5 seconds until you hear a beep and the User Program screen appears.
2. If modifying an existing program, use the scroll buttons to change fields (incline, speed, time, and segments).
 - Values for each field can be changed using the numeric keys or the FAST/SLOW speed buttons.
 - Each program has a max. of 40 segments.
 - When programming each segment, program in sequential order (i.e. do not skip time between segments).
 - If the program is less than 40 segments, leave the remainder blank.

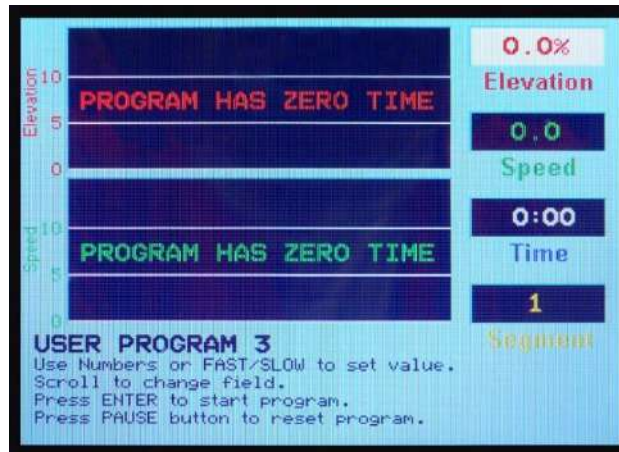

Fig. 95 Edit fitness program screen

3. Press ENTER once program details are entered to save program.
4. Press PAUSE to reset/erase the current program and write a new program.



Fig. 96 Example of customized fitness program screen

Run Customized Program

Once the fitness program has been edited and saved, the user can start training on the customized program.

Enter user weight and press ENTER to begin program.

When workout is complete, press the OFF button to exit the Edit User Programs screen and turn the treadmill off.

Changing Programs During a Workout

Simply press the FITNESS PROGRAMS key (or any other button in the menu) on the left of the screen to bring up the MAIN MENU and make another selection.

Programing User Programs

99 user program profiles are available. Each profile consists of 40 parts, each of which has programmable time, speed, and incline settings.

If a number key is pressed while the user is being prompted to make an entry, the program setup begins. The user program associated to this number key is displayed on the LCD display. The user can then set up the program and begin training. The user does not enter duration for user programs. Training duration is calculated by adding the values stored for the respective part (for this profile).

7.8.7 Fitness Tests

Balke Program

This program is designed to determine the user's current fitness level. Using the Balke protocol, this program evaluates the functional aerobic capacity (VO2max), with which the cardiorespiratory fitness of the user is determined. Under an increasing load, the oxygen consumption (VO2) eventually reaches a plateau. This is the desired maximum VO2 value.

Set the values for your age and sex using the number keys or the FAST/SLOW keys. Scroll to change fields. Press ENTER to start the program.

A chest strap is required for the test. Manually changing the speed or incline will make the test invalid. The test is terminated when the user's heart rate stabilizes at 130 BPM or at 80% of the user's maximum heart rate (whichever value is lower). Press the FAST speed key once to begin.

The time is automatically set to 20 minutes since the program has 20 program parts. In reality the test is terminated earlier. With this protocol the speed remains constant at 3.4 MPH (5.5 km/h). The incline in the first minute is 0% and in the second minute 2%. With each following minute the incline increases by 1%.

A fitness value is displayed along with the following tables, so that the user can track and evaluate his level of fitness (fitness value - VO2max value). The following tables are organized by gender and age group (10-79 years old).

Men

	10-19	20-29	30-39	40-49	50-59	60-69	70-79
High	56+	53+	49+	45+	43+	41+	39+
Good	46-55	43-52	39-48	36-44	34-42	31-40	29-38
Average	36-45	34-42	31-38	27-35	25-33	23-30	21-28
Adequate	27-35	25-33	23-30	20-26	18-24	16-22	14-20
Low	27	25	23	20	18	16	14

Women

	10-19	20-29	30-39	40-49	50-59	60-69	70-79
High	53+	49+	45+	42+	38+	35+	33+
Good	41-52	38-48	34-44	31-41	28-37	24-34	22-32
Average	33-40	31-37	28-33	24-30	21-27	18-23	15-21
Adequate	27-32	24-30	20-27	17-23	15-20	13-17	11-14
Low	27	24	20	17	15	13	11

Above charts from the American College of Sports Medicine (ACSM)

Gerkin Program With the Gerkin protocol there is a tiered VO₂ test with submaximal values. It is used by the International Association of Fire Fighters to determine fitness for service with the fire department.

Set the values for your age and gender using the number keys or the FAST/SLOW keys. Scroll to change fields. Press ENTER to start the program. During the test, do not manually change the speed or incline, as this will make the test invalid. This test calculates the user's fitness when the heart rate stabilizes at ____ BPM and the program terminates. Press FAST to start.

FITNESS TEST PROTOCOL WORKSHEET:

Name: _____

Resting heart rate (BPM): Trial I: _____ Trial II: _____ Trial III: _____

Blood pressure: Trial I: _____ Trial II: _____ Trial III: _____

Weight: _____ kg.

**Training target heart rate
(85% of HRmax):**

⚠ CAUTION
IF AT ANY TIME DURING A TEST THE USER EXPERIENCES CHEST PAIN, DIZZINESS, ATAXIA, CONFUSION, NAUSEA, OR COLD SWEAT, END THE TEST IMMEDIATELY!

- Place the heart rate device on the user.
- The user's heart rate is to be measured continuously throughout the test and in the cool-down phase. The heart rate is retrieved and recorded during the last 15 seconds of each phase.
- If the heart rate of the person exceeds the target training heart rate, continue the test in the phase in which the target training heart rate was exceeded for an additional 15 seconds.
- The test is completed and the final testing phase is given if the heart rate does not return to the target training heart rate (or a lower value) or when the person reaches phase 11.4.
- The VO₂max is determined using the heart rate retrieved during the final test phase and the conversion table.
- Record the heart rate after a one minute cool-down.

Phase	Minute	Speed (MPH)	Incline (%)	Heart rate (last 15 seconds of the phase)
Warm-up	3 minutes	3.0	0	
1	1	4.5	0	
2	2	4.5	2	
3	3	5.0	2	
4	4	5.0	4	
5	5	5.5	4	
6	6	5.5	6	
7	7	6.0	6	
8	8	6.0	8	
9	9	6.5	8	
10	10	6.5	10	
11	11	7.0	10	
Cool-down	1 minute	3.0	0	

PHASE	TIME	CALCULATED VO2max
1	1:00	31:15
2.1	1:15	32:55
2.2	1:30	33:6
2.3	1:45	34:65
2.3	2:00	35:35
3.1	2:15	37:45
3.2	2:30	39:55
3.3	2:45	41:30
3.4	3:00	43:4
4.1	3:15	44:1
4.2	3:30	45:15
4.3	3:45	46:2
4.4	4:00	46:5
5.1	4:15	48:6
5.2	4:30	50
5.3	4:45	51:4
5.4	5:00	52:8
6.1	5:15	53:9
6.2	5:30	54:9
6.3	5:45	56
6.4	6:00	57
7.1	6:15	57:7
7.2	6:30	58:8
7.3	6:45	60:2
7.4	7:00	61:2
8.1	7:15	62:3
8.2	7:30	63:3
8.3	7:45	64
8.4	8:00	65
9.1	8:15	66:5
9.2	8:30	68:2
9.3	8:45	69
9.4	9:00	70:7
10.1	9:15	72:1
10.2	9:30	73:1
10.3	9:45	73:8
10.4	10:00	74:9
11.1	10:15	76:3
11.2	10:30	77:7
11.3	10:45	79:1
11.4	10:00	80

Cooper Program

Set the values for your age and gender using the number keys or the FAST/SLOW keys. Scroll to change fields. Press ENTER to start the program. Run as far as you can in 12 minutes. TO ACHIEVE AN OPTIMAL RESULT THE SPEED MUST BE ADAPTED DURING THIS TEST. Leave the incline at 0%.

The test is to find out in how far an athlete can run/walk in 12 minutes. The assistant should round the results off to the nearest 100 meters.

The following tables show standard data for the Cooper test:

Age	Outstanding	Above Average	Average	Below Average	Weak
Male 13-14	> 2700 m	2400–2700 m	2200-2399 m	2100-2199 m	< 2100 m
Female 13-14	> 2000 m	1900-2000 m	1600-1899 m	1500-1599 m	< 1500 m
Male 15-16	> 2800 m	2500-2800 m	2300-2499 m	2200-2299 m	< 2200 m
Female 15-16	> 2100 m	2000-2100 m	1700-1999 m	1600-1699 m	< 1600 m
Male 17-20	> 3000 m	2700-3000 m	2500-2699 m	2300-2499 m	< 2300 m
Female 17-20	> 2300 m	2100-2300 m	1800-2099 m	1700-1799 m	< 1700 m
Male 20-29	> 2800 m	2400-2800 m	2200-2399 m	1600-2199 m	< 1600 m
Female 20-29	> 2700 m	2200–2700 m	1800-2199 m	1500-1799 m	< 1500 m
Male 30-39	> 2700 m	2300–2700 m	1900-2299 m	1500-1999 m	< 1500 m
Female 30-39	> 2500 m	2000-2500 m	1700-1999 m	1400-1699 m	< 1400 m
Male 40-49	> 2500 m	2100-2500 m	1700-2099 m	1400-1699 m	< 1400 m
Female 40-49	> 2300 m	1900-2300 m	1500-1899 m	1200-1499 m	< 1200 m
Male > 50	> 2400 m	2000-2400 m	1600-1999 m	1300-1599 m	< 1300 m
Female > 50	> 2200 m	1700-2200 m	1400-1699 m	1100-1399 m	< 1100 m

Rockport Program

Set the values for your age and gender using the number keys or the FAST/SLOW keys. Scroll to change fields. Press ENTER to start the program. Walk 1 mile (1609 m) as fast as you can. TO ACHIEVE AN OPTIMAL RESULT THE SPEED MUST BE ADAPTED DURING THIS TEST. Leave the incline at 0%. You must wear a chest strap or hold on the grips.

Conduct Test:

- Record your weight.
- Walk 1 mile (1609 m) as fast as possible.
- Record your time to complete the 1 mile (1609 m).
- Record your heart rate after finishing the walk (BPM).
- Determine your VO2max value using the formula below.

Analyze Results:

The analysis of the results is to compare the results with the results of previous test trials. It can be expected that, with appropriate training, improvement will be seen between trials.

The formula for the calculation of VO2max value is as follows:

- $132.853 - (0.0769 \times \text{Weight}) - (0.3877 \times \text{Age}) + (6.315 \times \text{Gender}) - (3.2649 \times \text{Time}) - (0.1565 \times \text{Heart rate})$

The following apply:

- Weight: Record in pounds (lbs.)
- Gender: Female records "0" and male records "1"
- Time: Minutes and hundredths of minutes
- Heart rate: Beats per minute (BPM)
- Age: Years

Female				Male			
Age	High	Average	Low	Age	High	Average	Low
18-21	> 45.3	42.7-41.0	< 39.4	18-21	> 56.1	52.4-54.1	< 49.8
20-29	> 40.9	36.7-33.8	< 30.6	20-29	> 48.2	44.2-41.0	< 37.1
30-39	> 38.6	34.6-32.3	< 28.7	30-39	> 46.8	42.4-38.9	< 35.4
40-49	> 36.3	32.3-29.5	< 26.5	40-49	> 44.1	39.9-36.7	< 33.0
50-59	> 32.3	29.4-26.9	< 24.3	50-59	> 41.0	36.7-33.5	< 30.2
60+	> 31.2	27.2-24.5	< 22.8	60+	> 38.1	33.6-30.2	< 26.5

7.8.8 Military Test Programs

The Military Test programs provide workouts of a preset distance, as required by the Army, Navy, USMC, and USAF. They are used to assess muscular endurance and cardio-respiratory fitness. As the names imply, the object of each test is to complete the run distance as quickly as possible. At the completion of the test, a time-based score (defined by the respective branch of the Military) is returned to the user. Each test begins with a treadmill incline of 1% (best simulates outdoor running).

Army Program

Using the number keys or FAST/SLOW keys, set your age and gender values. Scroll to change between fields. Press ENTER to start the program.

Run as fast as you can for 2 miles (3.2 km). For the best score, you must adjust your speed during the test. Leave incline at 0%. Press FAST to start. You can find the scoring standards online: <http://army.com/info/apft/twomileruntable>

Air Force & Navy Programs

Using the number keys or FAST/SLOW keys, set your age and gender values. Scroll to change between fields. Press ENTER to start the program.

Run as fast as you can for 1.5 miles (2.4 km). For the best score, you must adjust your speed during the test. Set the incline to 1.0%. Press FAST to start. You can find the scoring standards online:

<http://www.afpc.af.mil/shared/media/document/AFD-110804-054.pdf> (USAF), <http://www.uscg.mil/sapr/docs/pdf/Fitness%20Assessment%203-28-.pdf> (USCG), and http://www.public.navy.mil/bupers-npc/support/21st_Century_Sailor/physical/Documents/Guide%205-Physical%20Readiness%20Test.pdf (USN) (*Note: Air Force Program, Coast Guard Program, and Navy Program differ only in the way the results are given; Air Force results are given in a point system.*)

Marines Program

Using the number keys or FAST/SLOW keys, set your age and gender values. Scroll to change between fields. Press ENTER to start the program.

Run as fast as you can for 3 miles (4.8 km). For the best score, you must adjust your speed during the test. Leave incline at 0%. Press FAST to start. You can find the scoring standards online:

http://www.marines.mil/Portals/59/Publications/MCO%206100.13%20W_CH%201.pdf

7.8.9 Saving Workouts to USB

With the 4Front treadmill, it is possible to save your workout information to a USB stick to review on your computer and track your personal training progress over time. This is possible with both the standard LED display and the Personal Trainer Display. You cannot make your own programs and save them on the USB stick.

1. Insert USB stick into USB port beneath 4Front interface display.
2. Turn the treadmill ON. The treadmill will begin recording data to the USB from whatever time you insert it into the USB port until you finish training.
3. After inserting the USB, the LED display should light up "USB Good" or "USB FOUND" if the USB is compatible.
 - If the USB is incompatible or full, the LED display will light up "USB OFF".
 - If the USB is incompatible, a different USB will be necessary.
4. After completing workout, press the OFF button once and the screen will flash "USB Save".
5. Remove USB after the display powers down.

LED Display (Standard)



Personal Trainer Display (**Optional)



Fig. 97 USB compatibility displays

Uploading Data to Computer

The saved file (.XML format) contains your workout data including workout time, calories burned, distance (miles), speed (MPH), pace (s/mi), incline (%), vertical feet, heart rate (BPM), and METs.

1. Plug your USB into the computer.
2. Upload the .XML file to a designated folder on your computer.

8 Options and Accessories

8.1 Power Input 208 / 230 V

The 208/230 VAC input voltage requirements are options for all WOODWAY treadmills. An input power transformer for 208/230 VAC has been installed and connected. This does not affect the other parts of the treadmill.

8.2 Handrail Controls

(Not available on PATH)

One of the unique features of WOODWAY treadmills is the side controls on the railing. By using the controls on the railing the user can adjust the speed and/or incline without leaning over the display, allowing the user to continue running and minimizing the risk of losing the balance and/or falling.

The control panel on the railing consists of five keys: STOP, SPEED INCREASE, SPEED DECREASE, INCLINE UP, and INCLINE DOWN.

8.3 Reverse Mode (Bi-Directional Belt Control)

WARNING

Do Not Leave Treadmill Unattended While in Reverse Mode!

If the treadmill is left unattended while in reverse mode, there is a possibility of personal injury from users stepping onto device while assuming the running surface will move normally.

- ▶ Never leave the treadmill unattended while in reverse mode.
- ▶ Always use supervision while training in reverse mode.
- ▶ Keep children and animals clear of the treadmill while it is in reverse mode.

The bi-directional belt control feature is an option for some of our models. *This option will only be activated if it was selected upon purchase.*

The incline system is not affected by this option. In the reverse direction, speed is limited to approx. 5 MPH (8 km/h) for safety reasons. Constant supervision is required while the treadmill is in reverse.

1. Hold down the SLOW button for 5 seconds while speed is set to 0 MPH (km/h).
2. The display will beep 3 times to let the user know reverse mode is in effect.
 - While in reverse mode, the SPEED will be displayed as a negative value (e.g. -2.3 MPH)
 - If on an LCD Personal Trainer Display Board, the LCD display will read "Reverse Mode"
3. To exit reverse mode, hold the SLOW button for 5 seconds while the speed is at 0 MPH (km/h). The display will beep 3 times to let the user know that forward mode has been restored.

8.4 Top Speeds Upgrade

WARNING

Constant Supervision is Required!

When training at faster speeds, especially from a top speed upgrade, there is an increased chance of injury or damage from falling.

- ▶ Always supervise users when training at top speed.
- ▶ Do not train at top speed until you have reached the proper conditioning and training level necessary to train safely.

Options are available to increase top speeds depending on the model. These options are mainly used for sports medicine and the training of elite, conditioned athletes (some will require 208/230V) and vary depending on the treadmill model.

8.5 RS-232 Remote Computer Control

This option enables you to switch between the treadmill display and a remote computer for remote control operation. Programs are available from WOODWAY.

WOODWAY treadmills are tested to UL/CSA standards with an Intel DG41RQ computer.

8.6 TV Programming, 4Front/Pro/Pro-XL

You can move around any menu using the following buttons:

Volume (VOL)

Move across the main settings tab on the top of the display and change option values within a menu screen.

Channel (CH)

Move up and down the option selections within a menu.

BACK

Exit the menus.

Change TV Input

The process by which the user can change the TV input is the same throughout both North America and Europe. To change the TV input, perform the following steps:

1. Press the INPUT button.
2. Use the CH [+][-] buttons to move up and down the menu.
Once you have selected your input source, press the ENTER key to accept it.

8.6.1 North America

To access the LCD programming options:

1. Turn on the TV.
2. Be sure that the TV input is selected, if not:
 - Press the INPUT key until you see the input selection box.
 - Use CH[+] and/or CH[-] buttons to navigate up and down.
 - Once the TV input is highlighted, press the ENTER key to confirm your selection.



Fig. 99 Input menu

3. With the TV set to the correct input mode, press and hold the ENTER key for 5 full seconds. Release the ENTER key and press the BACK button. This will open the TV menu screen. Release the button when the menu appears.



Fig. 100 TV Menu screen

4. When viewing the TV menu screen:
 - Use the VOL[+] and VOL[-] buttons to move across the different menu icons on the top of the screen.
 - Use the CH[+] and CH[-] buttons to scroll through different menu items.
 - When highlighting a submenu item, use the VOL[+] and VOL[-] to toggle through the options for that item, e.g. the "AIR/CABLE" input options within the "CHANNEL" submenu.
 - Press ENTER to confirm your selection.
 - Press the BACK button to return to the previous menu level.

Channel Scan

To perform a channel scan, you must be in the "CHANNEL" submenu.

5. The "CHANNEL" submenu should be the first submenu to open when opening the TV menu screen. If you are not on the "CHANNEL" submenu, use the VOL[+] and VOL[-] buttons to navigate through the icons.
6. Press the CH[-] key once to highlight "AIR/CABLE" and select the input source.
 - If you are using over-the-air digital TV signals through an antenna, select "AIR".
 - If you are connected to a cable TV provider or through a cable distribution network use "CABLE".

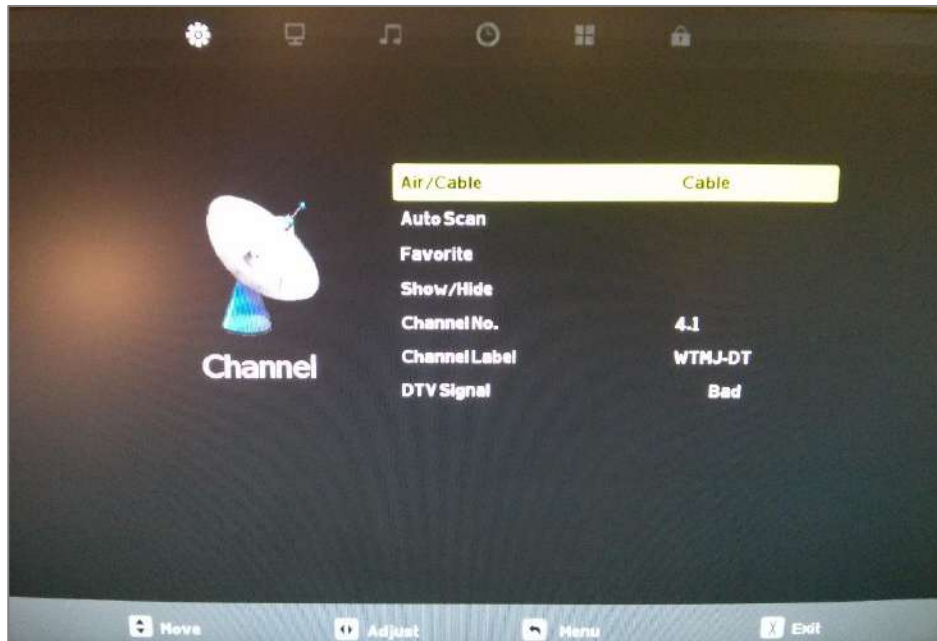

Fig. 101 Channel submenu

7. Once the correct input option is chosen, press the CH[-] button once to highlight "AUTO SCAN".

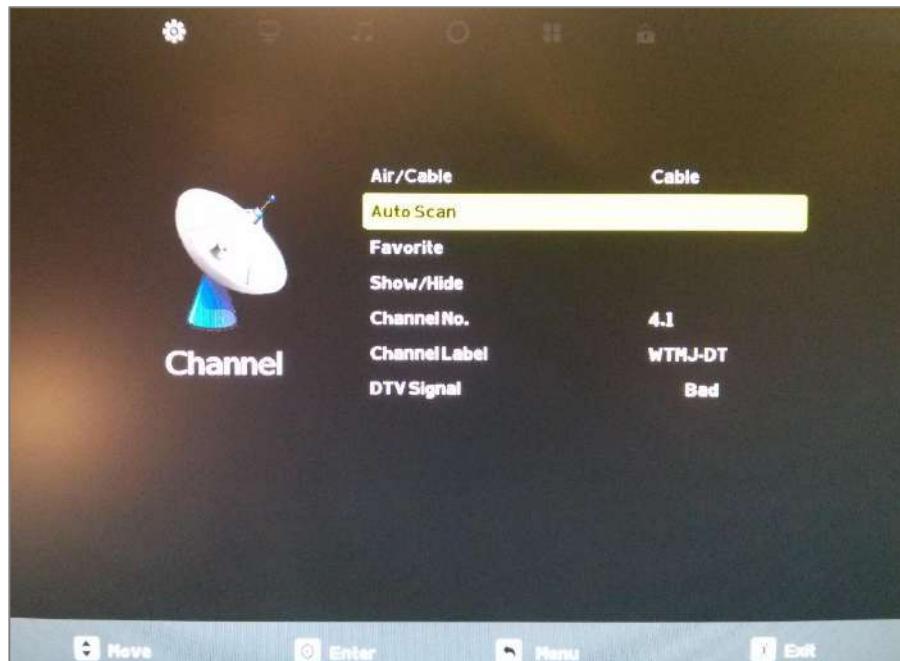

Fig. 102 AutoScan option

8. Press ENTER or VOL [+] to begin the scan.
9. A pop-up box will ask if you are sure you wish to continue.

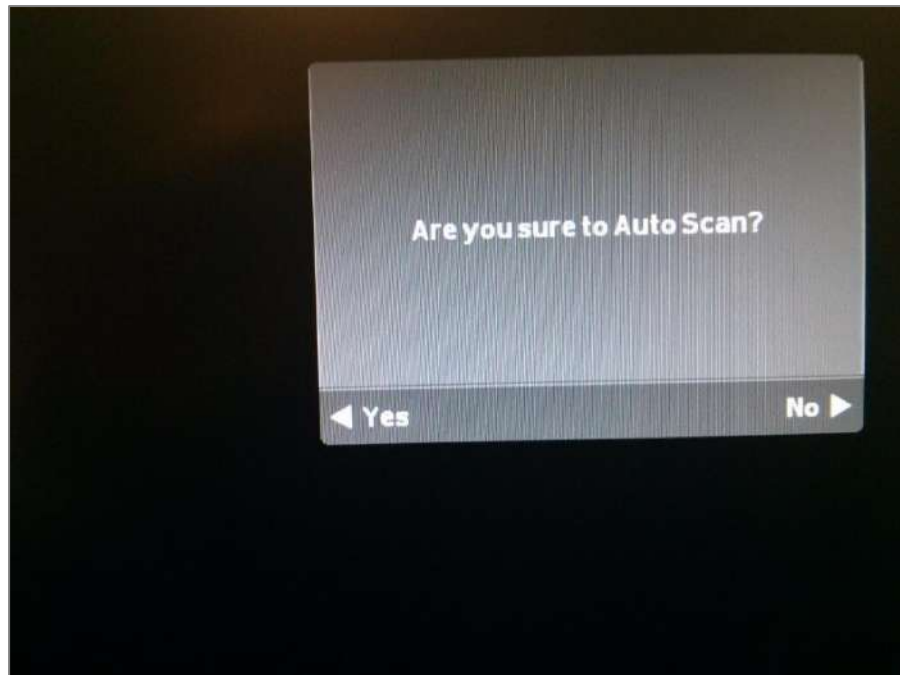

Fig. 103 Are you sure pop up

10. Press the VOL[-] key to accept the warning and begin the scan.

The TV will then begin to scan the channels and display the current status and the overall progress.

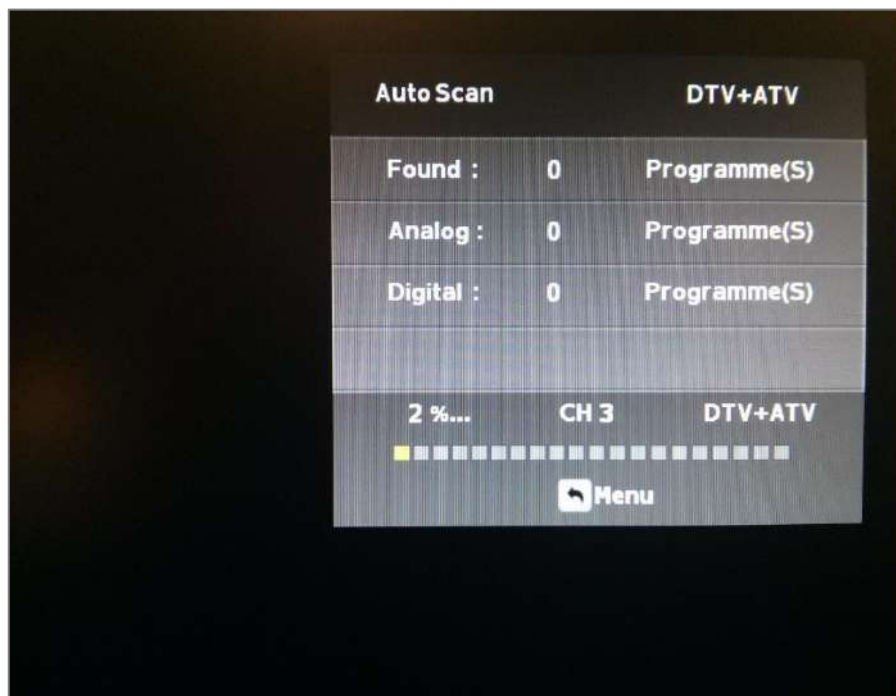

Fig. 104 AutoScan progress

Once finished, the TV will tune to the first available channel found.

Closed Caption Procedure

To adjust closed caption settings, first follow Steps 1 – 4 to navigate to the TV Menu screen. Then follow the steps outlined as follows:

To adjust closed captions, you must be in the "SETUP" submenu.

1. Once viewing the TV menu screen, use the VOL[+] and VOL[-] buttons to navigate the menu items until you reach the "SETUP" submenu as pictured below.

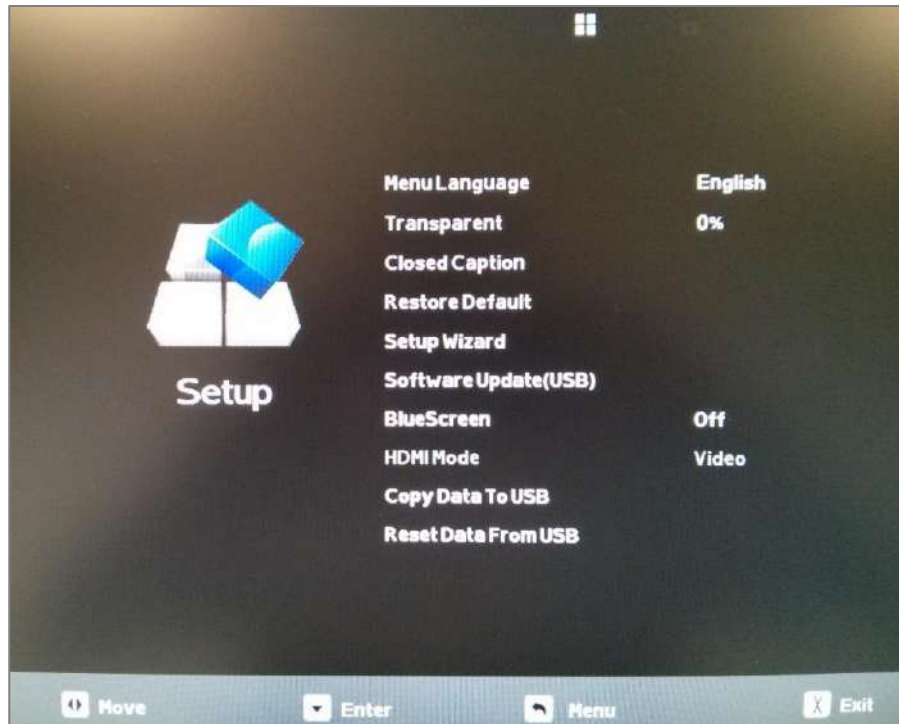

Fig. 105 Setup menu

2. Press the CH[-] key to move through the menu and select "CLOSED CAPTION".



Fig. 106 Closed caption option

3. With "CLOSED CAPTION" highlighted, press ENTER to open the closed caption selection screen.

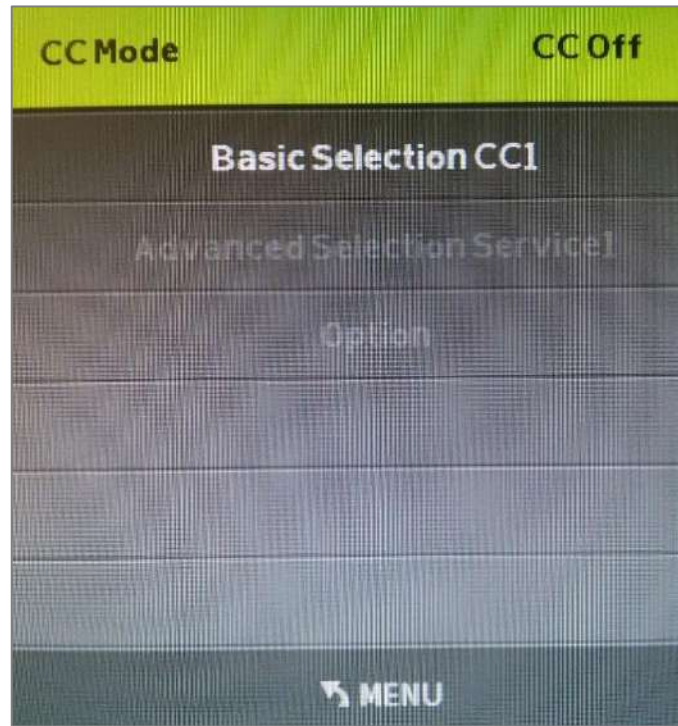

Fig. 107 Closed caption selection screen

4. Press either VOL[-] or VOL[+] to turn the CC MODE to "CC ON".

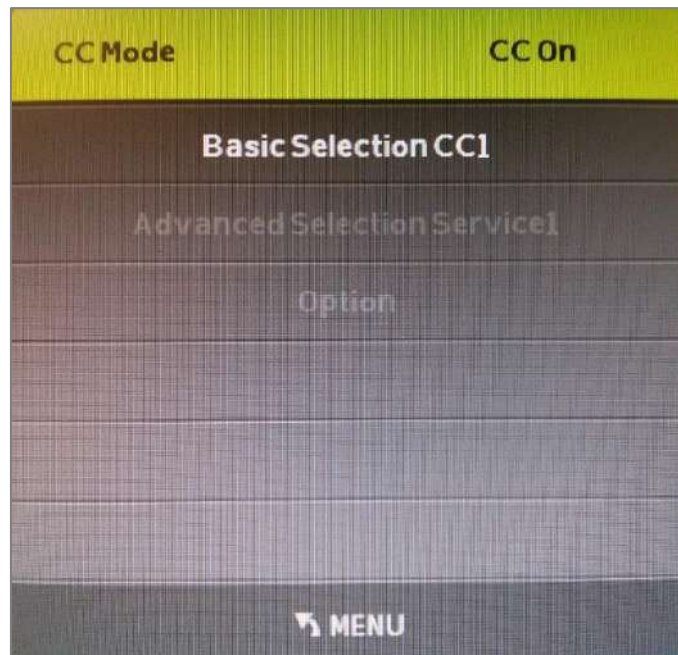

Fig. 108 CC Mode ON/OFF

5. Press BACK to exit the menus and return to the TV display.

8.6.2 Europe

To access the LCD programming options:

1. Turn the TV on.
2. With the TV on and in the correct input mode (either DTV or ATV input), hold down the ENTER button and press the BACK key.
 - This opens the TV menu screen.
 - Release both keys when the menu appears.
3. Press VOL [+] to move across the menu screen icons until you reach the "CHANNEL" menu with the antenna icon (first icon).



Fig. 109 TV configuration screen, Europe

4. Press the CH [-] button to enter the menu and highlight the "AUTO TUNING" option (first line).



Fig. 110 TV source screen, auto tuning

5. With "AUTO TUNING" highlighted, press the ENTER key to enter the tuning menu (upper right-hand corner of the screen).



Fig. 111 TV source screen, tuning menu

6. Use the VOL [+] button to move through the different tuning options.
 - DTV (digital stations) only
 - ATV (analog stations) only
 - DTV and ATV
7. Press the CH [-] button to reach the country selection option of the menu.
 - "UK" will be chosen as the default country.
 - If this is correct, press ENTER to begin the scan.
 - If this is not correct, use either the CH [+][-] or VOL [+][-] buttons to navigate to the correct country.
 - Press ENTER to select the appropriate country.



Fig. 112 TV source screen, country selection

8. The TV will then scan for available channels and the following screen will appear. Once finished, the TV will tune to the first channel found.



Fig. 113 TV channel tuning screen

8.7 Accessories and Services

The following accessories and services are available from WOODWAY:

Replacement Safety Magnet

Protective Treadmill Floor Mat

Protect the flooring or carpeting below your WOODWAY and keep your treadmill clear of obstructions (i.e. thick or high-pile carpet).

RFID System with 100 Key Fobs

Preventative Maintenance Kit

Kit includes:

- Dry graphite lubricant*
- Tube of black grease*
- Canned air*
- Extension tool with TORX-20 bit*

WOODWAY Renewal Program

This entails having your treadmill shipped back to WOODWAY via Van Line (WOODWAY can coordinate these details; cost is additional). Your treadmill will then be thoroughly renovated by a qualified WOODWAY Service Technician. Any worn/outdated features will be replaced. The treadmill will then carry a one (1) year parts and labor warranty. It's like getting a brand new WOODWAY at a fraction of the cost.

Contact the WOODWAY Service Department or your sales representative to order at 1-800-WOODWAY (1-800-966-3929)

9 Cleaning and Maintenance

WARNING

Danger of Injury due to Lack of Qualifications!

If maintenance or repairs are not carried out by professionally qualified personnel, serious injury and material damage may occur.

- ▶ Maintenance and repair work may only be performed by qualified personnel.
- ▶ It is the sole responsibility of the representative to assign qualified personnel for maintenance and repair work.
- ▶ Clean and examine the machine regularly for damage and/or wear, paying special attention to areas susceptible to wear.
- ▶ In case of doubt or questions, always contact WOODWAY Customer Service or your dealer.
- ▶ The manufacturer is not liable for personal injury and material damage caused by a lack of qualifications!

9.1 Cleaning

Periodic cleaning and inspection of your WOODWAY treadmill will help lengthen its life while keeping it looking like new. With this preventative maintenance it will be easier to identify possible issues that might otherwise be overlooked.

Below is a guideline of recommended cleaning and maintenance intervals.

DANGER

Danger of Death by Electric Shock!

The use of water and liquid detergents as part of cleaning can cause serious or fatal electrical shock.

- ▶ No liquids may come in contact with electrical parts such as motor, power cord, power switch, and control monitors.
- ▶ Do not spray the device with a water jet.
- ▶ Pull power plug before cleaning; equipment must not be connected to power! Ensure the device cannot be switched back on.

The running surface should be thoroughly cleaned at regular intervals, depending on the intensity of use.

Remove light dirt and dust with a soft cloth. Dirt can be removed with damp cloth and mild soapy water. After cleaning dry with a dry cloth!

Cleaning Notes

- Do not use abrasive brushes or abrasive cleaners, as the paint and plastic surfaces can be scratched.
- Do not use sharp tools (e.g. knife, metal scraper) or aggressive cleaning solvents for cleaning.
- Clean all surfaces with a mild, non-abrasive detergent (eg. *409* or *Fantastic*, diluted with water to 50/50).
- To avoid damage to component surfaces, observe the instructions for detergent use.
- For cleaning and disinfection of parts that are touched (handrail, display, controls, etc.) a formaldehyde-free rapid disinfectant such as "Bacillol plus" or "Descosept" is recommended.

9.2 Maintenance Intervals

DANGER

Danger of Death by Electric Shock!

Maintenance and inspection work on the unit may cause serious or fatal electrical shock.

- ▶ Pull the power plug prior to any maintenance and inspection work on the equipment. The device must not be connected to the power.
- ▶ Ensure the device cannot be switched back on.

Weekly Maintenance

- Clean handrails, display, and side covers with a damp cloth.
- Disinfect railings and controls.
- Clean the running surface with a damp, lint-free cloth.
- Visually check the power cord for damage.
- Check the treadmill for mechanical damage.
- Check mounting of all controls (display, emergency stop mushroom, side panels)
- Clean the area under the treadmill (vacuum and mop).

CAUTION

Worn or damaged components must be replaced immediately. If the observed deficiency can cause danger to the user or operator of the treadmill, it needs to be taken out of service until repaired.

Monthly Maintenance

A complete function test of the treadmill must be carried out every 2 - 4 weeks depending on the duration and intensity of use.

The function test includes the following:

1.	Use the treadmill for a short time at speed of 3.5 - 6 MPH (6 - 10 km/h). Do unusual noises occur?
2.	Turn up treadmill to max. speed for a short time. Does the treadmill reach the specified max. speed? Do unusual noises occur?
3.	Does the display correctly show the distance traveled at top speed?
4.	Stop the treadmill and move it to max. incline. Does the treadmill reach the desired incline?
5.	Do unusual noises occur while the treadmill is running at max. incline?
6.	Check the emergency stop magnetic switch function. Is an emergency stop initiated?
7.	Check the function of the emergency stop mushroom and/or button.
8.	Set the treadmill to STAND-BY mode. Though slight movement is normal, the running surface must be very difficult to move. Is the running surface stopped correctly?

ATTENTION

If there are defects or deviations in the control function, notify WOODWAY Customer Service immediately.

The device must be taken out of service and disabled until repaired. Repairs may only be carried out by trained and authorized personnel.

Before starting any maintenance, remove the side panels (NOT electronics covers).

Preventative maintenance consists of the following measures:

- Clean the inside of the treadmill with a vacuum cleaner. Do not touch the electrical components (cables, transformers, connectors, etc.).
- Visually check the drive unit toothed belt (drive belt) for cracks and other wear and missing or broken teeth.
- Inspect the aluminum profiles of the slats for damage.
- Visually inspect all mechanical components for damage (lifting mechanism, welded frame, side panels, treadmill feet, rollers on the lifting scissors, railings, display, emergency stop mushroom, emergency stop magnetic switch).
- In rare cases there may be bearing damage. Under certain circumstances this can be detected through excessive grease leakage from the bearing housing.
- Have the time limits prescribed by the manufacturer for the maintenance and safety checks been complied with?

A repair must take place in the following situations:

- Liquid has gotten into the device
- Damaged power cord (cable, plug)
- Defective drive system toothed belt
- Suspected bearing damage
- Suspected/established device defect
- Bucking, sudden stopping, or accelerating of the running surface
- Button(s) fail to function
- Burning smell, smoke, or unusual noises
- Malfunction (failure) of the emergency stop button
- Malfunction (failure) of the emergency stop magnet
- Damage to the running surface belt
- All other defects which may affect the safety of the device

Semi-Annual Maintenance

- Vacuum inside the treadmill (unplug device and remove side covers).
- Inspect all nuts and bolts. Tighten if necessary.
- Clean running surface and spray with anti-static spray.
- Check drive belt (replace if shredding or if teeth are missing).

Annual Maintenance

A complete function test of the treadmill must be carried out every 2 - 4 weeks depending on the duration and intensity of use.

The proper maintenance of the treadmill must take place annually in conjunction with the Technical Safety Checks (TSC).

In exceptional cases, the maintenance interval may be adapted to the extended inspection intervals in accordance with Technical Safety Checks (TSC). Maintenance and repairs may only be carried out by trained and authorized personnel.

NOTE

It is recommended to enter maintenance and repairs in the Maintenance Report (see Section **Error! Reference source not found.** Page **Error! Bookmark not defined.**).

Significant measures for inspection of the treadmill:

- Treadmill installation
- Running surface belt
- Drive unit and the lifting system
- Nuts and bolts
- Secondary bearing and guide rollers
- Electronics

For further information on maintenance procedures, refer to the separate service manual.

9.3 Lubrication

9.3.1 Bearings

Almost all bearings in the treadmill have been lubricated by the manufacturer and need not be greased. The 4 bearings at the front and rear axles must be lubricated once a year with one stroke of the grease gun.

- Remove the side panels when lubricating bearings.
- One pump of grease can be inserted into zerk fittings on bearings (need a grease gun with a flex bit).
- If necessary, tighten bolts that secure bearings to the frame.



Fig. 114 Lubrication, axle bearing

9.3.2 Running Surface Belt, Drive Axle

The teeth on the bottom of the tread belt are sufficiently lubricated in the factory to minimize noise. The teeth do not need to be lubricated. When the running surface belt rubs on the side of the guide rollers, the use of a small amount of lubricant (Molykote or similar product) on the edges of the v-guide can contribute to noise reduction. To ensure correct tread belt alignment, apply grease to the teeth on the rear driving axle.

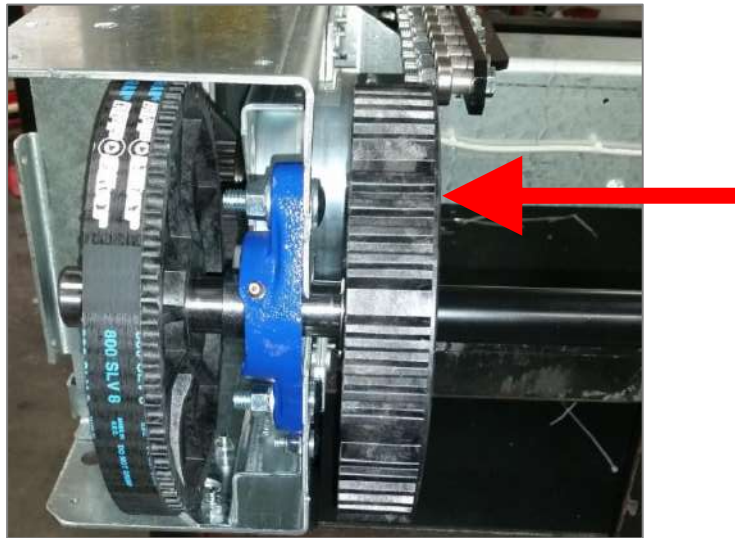

Fig. 115 Lubrication, drive axle

9.3.3 Drive Belt

As with the running surface belt, the use of a small amount of grease on the edge of the belt is only necessary to reduce squeaking of the belt. Grease should be used sparingly.

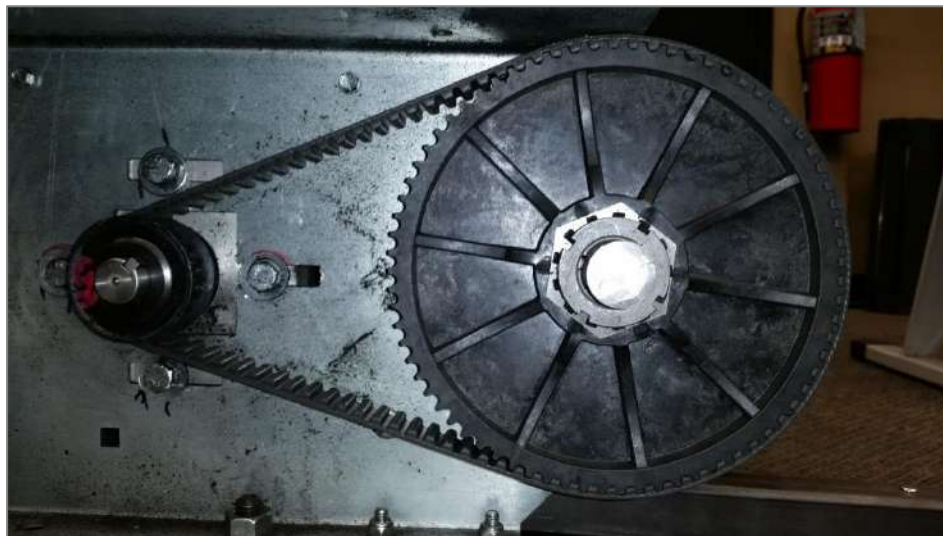

Fig. 116 Lubrication, toothed belts

9.3.4 Incline System

The incline systems on WOODWAY treadmills are lubricated by the manufacturer. The system must be checked when used over several hours or in a very dusty environment. If required, apply a small amount of oil to the chain and grease to the incline drive racks.



Fig. 117 Lubrication, incline system

1. Incline toothed rack
2. Incline chain

Note: Use a minimal amount of lubricant to prevent excess dirt and debris from sticking to the device after cleaning.

9.4 Adjusting and Calibrating

Incline System

WOODWAY treadmills use an incline system with a toothed rack and gear drive. For systems with an incline of 15% to 25% similar components are used; they differ with respect to the movement of the toothed rack.

Handrails

Inspect/tighten all hardware. Replace any hardware that is stripped or missing. Inspect the handrail clamps for damage (e.g. cracks).

Bearing Rails

Remove 2 running belt slats to access the bearing rail assemblies. Clean the bearing rails and replace any bearings that are causing noise or that do not spin freely.

Treadmill Feet

Required tools: 2 ft. level

When the treadmill wobbles or seems unstable, the support feet must be checked. Check both ends of the treadmill with a level. See Section 6.3.1

Note: When the treadmill is moved, the frame may bend. If the treadmill seems to wobble, press down on the railing on either side. This can realign the railing without making a support foot adjustment necessary.

Running Belt The running surface belt does not usually need adjustment. However, when the running surface belt or corresponding parts are replaced, the belt tension must be checked.

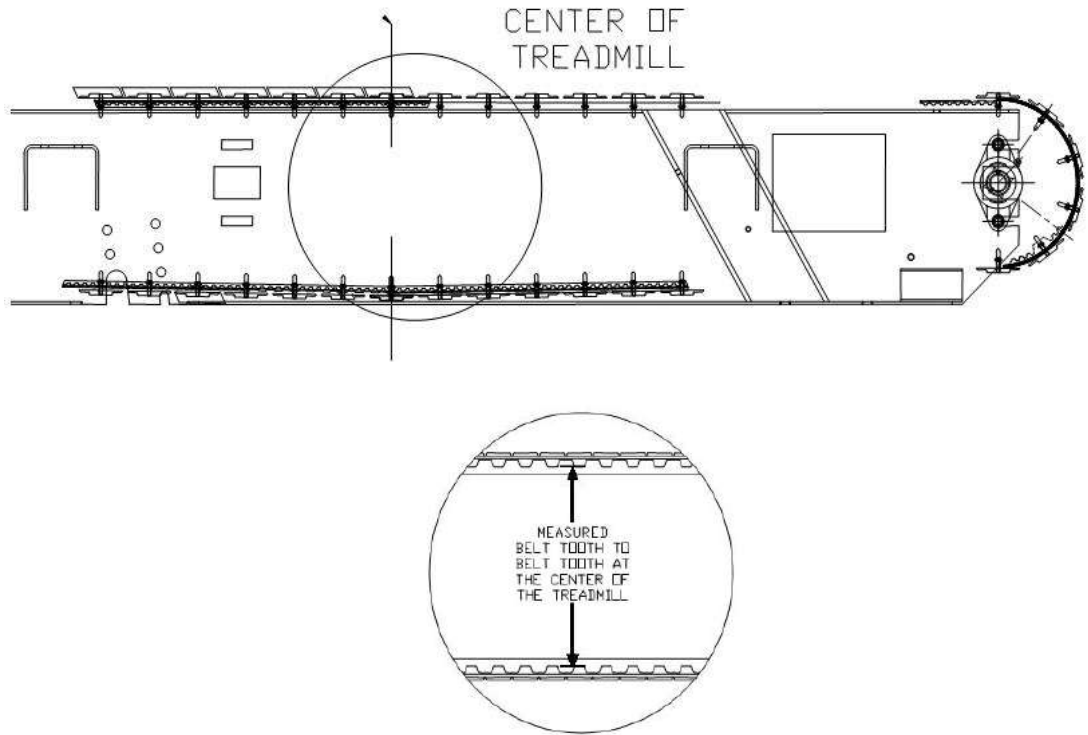

Treadmill	Teeth to Teeth
Path	8.25"
Desmo/4Front/Mercury	8.5"
Pro Med	8.75"
Pro-XL Med	9.0"
ELG	16.5"

9.5 Disabling the Treadmill

Disabling is required if the safety of the treadmill is not guaranteed or if it is suggested that this could be the case.

A device must be disabled if the following symptoms occur:

- Unusual noises
- Appearance of smoke
- Uncontrolled stopping or accelerating of the treadmill
- Rocking of the running surface belt
- Damage to slats or other mechanical damage
- Spilling of liquid on the treadmill
- Other symptoms/situations which could cause danger to the user/operator

Disabling can also be requested of WOODWAY Customer Service by telephone. In this case, the treadmill representative is obliged to carry out the disabling and to confirm with WOODWAY Customer Service in writing.

Exceeding the test periods by several months (see previous chapter) also makes temporary disabling of the treadmill necessary.

ATTENTION

The representative is responsible for property damage or personal damages caused by incorrectly disabling or not disabling the treadmill.

The disabling of the treadmill must be such that an unintentional and/or unauthorized restart can be ruled out and that the name of person who is authorized to put the treadmill back into operation can be seen.

The representative is to disable medical treadmills in the following situations:

- There is reasonable suspicion of danger to the health and safety of patients, employees, or third parties
- Defects exist that could endanger patients, employees, or third parties

The removal of the power plug from the outlet alone is not sufficient for the disabling of the treadmill, since third persons who have not been informed about the disabling could plug the treadmill back into the power supply and use it.

The following measures must therefore be taken to disable a WOODWAY medical treadmill:

1. The unit must be turned off and the power plug must be unplugged from the wall socket (disconnected).
2. The treadmill must be marked "disabled" in a clear manner such as: "CAUTION DANGER OF INJURY" and the notice must be clearly displayed. In addition, the date of disabling, reason for disabling, and name of the person/organization that disabled must be specified.
3. It must be determined which authorized person - possibly after maintenance and repairs - may start up the treadmill again.
4. The fuses must be removed from the power supply box and kept in a safe place. Attach one of the following safety labels to the treadmill power supply fuse box.
5. Apply the second safety label to the plug of the power cord.

Labels for Disabling a Treadmill

✂

○



**CAUTION
DANGER OF INJURY!**

This device has been disabled due to safety defects.
THE USE OF THIS DEVICE IS STRICTLY FORBIDDEN!

Device was disabled on (date) : _____

By (name): _____

Only the following person may put this device back
into operation: _____

✂

○



**CAUTION
DANGER OF INJURY!**

This device has been disabled due to safety defects.
THE USE OF THIS DEVICE IS STRICTLY FORBIDDEN!

Device was disabled on (date) : _____

By (name): _____

Only the following person may put this device back
into operation: _____

9.6 Device Fuses

The fuses must comply with the published technical specifications (see Section **Error! eference source not found.** Page **Error! Bookmark not defined.**). Bridging the fuses is prohibited, due to the risk of electric shock and fire.

When replacing a fuse, turn off the power using the main power switch and unplug the power cord from the outlet. Using a screwdriver, unscrew the fuse holder from the power junction box. Change the fuse and screw the fuse holder into the terminal box.

Note: The figure below is of a WOODWAY PPS Medical Treadmill. The process for removing and replacing the fuse is identical to that of all WOODWAY medical treadmills.



Fig. 118 Device fuses

10 Troubleshooting

ATTENTION

With the exception of the maintenance work described in this chapter, the treadmill can only be checked and repaired by qualified personnel.

If necessary, contact an authorized WOODWAY dealer or WOODWAY Service Center.

If you have problems with your treadmill, please consider the answers to the following questions before calling WOODWAY Customer Service:

- What are the make, model, and serial number?
- What happened before the problem occurred?
- Did the problem occur suddenly or slowly over time?
- Was the treadmill in use when the problem occurred?
- Was the running surface ENGAGED or was it in DYNAMIC MODE?
- Explain all the other information that you consider relevant.

10.1 Unusual Noises

Visual Inspection

Perform a visual inspection of the running surface belt and verify that the running surface is not obstructed by an object under, in front of, or near the device. Remove any obstacles that could obstruct or damage the running surface.

Check whether the running surface inadvertently brushes against the side panel and leads to excessive wear. If this is the case, correct the gaps between the running surface and side panel.

Toothed V-Belt

The teeth on the bottom of the tread belt are sufficiently lubricated in the factory to minimize the noise. In certain cases it may occur that the combination toothed V-belt rubs against the pulley guides, thus producing whistling sounds. In this case, the use of a small amount of lubricant (Molykote or similar product) applied to the edges of the endless belt can contribute to noise reduction. Do not use too much grease, as this leads to an unnecessary accumulation of dust and dirt.

Toothed Belt Drive

As with the running surface belt, the use of a small amount of lubricant on the edge of the belt is only necessary to reduce a "whistling" of the belt. Lubricant should always be used sparingly.

Bearings

When noises come from the bearings, bearing damage is to be expected. If this is the case, the bearing must be replaced by a trained and authorized technician.

10.2 No Display

If the display is not lit when you turn on the treadmill, check the following points:

- Is the treadmill connected to the power source?
- Is the main switch on the power connector box switched on?
- Check that the power main's input fuse is properly functioning (replace if defective).
- Can the fan that is used to cool the servo controller (on the runner's right) be heard?
- Does the socket to which the treadmill is connected supply power (e.g. could the circuit breaker for the supply line have been triggered)?

10.3 Running Surface Does Not Move

If the display and/or lifting mechanism works but the treadmill does not accelerate when the [+] button is pressed, do the following:

- Ensure the emergency stop magnet is in place. Try to reposition the magnet.
- Ensure the emergency stop button is in the released position. If button is activated, twist clockwise to release.
- Check if the running surface belt is blocked by an object and if so, remove.
- Turn off the power at the main switch and unplug the power cord. Wait 60 seconds before reconnecting to power and turning on the main switch.

10.4 Free Moving Running Surface

It is always possible to rotate the running surface belt slowly when the drive is not engaged. The more energy used to move the running surface, the greater the motor's braking effect (short circuit brake). This behavior is normal.

When the drive is not engaged (i.e. STAND-BY mode) the running surface belt is slowed down by short circuit of the three motor phases. A totally free-moving running surface belt might be a defective short circuit relay or a broken wire.

If the treadmill is turned on by the switch on the display and the indicator in the display is active, this is a sign that the motor is defective or it is a failure of the servo controller.

In both cases the treadmill must be disabled immediately according to the instructions in this manual.

10.5 Incline Does Not Function

- If the incline motor makes noises, a brake may be stuck or the motor may have stopped.
- Check if the incline-limit switch has been tripped.
- Ensure that the chain is not broken and has not slipped from the sprocket.
- Ensure that the potentiometer is set properly.

10.6 Irregular or Flashing Display

- Ensure that the treadmill is connected to an independent power line.
- Verify power source is rated to match the electrical specifications listed on your unit's serial label.
- The power supply for the display on the interface card may be defective; contact WOODWAY Customer Service.

10.7 Sources of Electromagnetic Interference

Close proximity to, for example, X-ray equipment, powerful motors, or isolating transformers must be avoided because of possible electromagnetic interference.

Electromagnetic interference can affect the operation of your treadmill.

10.8 Interference of the POLAR® Heart Rate Monitor

During the transfer of data from the transmitter to the receiver the POLAR® heart rate monitoring may receive interference, which is triggered by other devices in the proximity of the treadmill. The most common causes for this are:

- PC screens, computers, radio systems of all kinds
- High tension power lines
- Intense light exposure
- Strong magnetic fields

10.9 Calibrating Belt

When the treadmill is set to 0 MPH, the belt may move slightly due to electrical variance. It is possible to adjust this movement through the treadmill display board. The procedure for calibrating belt movement differs slightly between models.

LCD Personal Trainer Display Board

To adjust the belt movement of your treadmill through the color LCD display, perform the following steps:

1. Turn the treadmill OFF and back ON again by the main power switch.
2. Press the ON button on the display board.
3. Press 9-2-2-ENTER (in that order).
4. Press either UP/DOWN incline key to stop the belt movement. Do not press the keys too fast, as the treadmill may not respond.
5. Once the belt is stopped, press the OFF button twice to save the changes and exit calibration mode.

LED Standard Display Board

To adjust the belt movement of your treadmill through the LED display, perform the following steps:

1. Turn the treadmill OFF and back ON again by the main power switch.
2. Hold down the INCLINE UP button and press the ON button on the display board. Release both buttons.
3. Press the INCLINE UP button until the display reads "bCrP".
4. Use either FAST/SLOW key to stop the belt movement.
5. Once the belt is stopped, press the PAUSE button to save the changes. Turn the treadmill OFF at the main power switch to exit calibration mode.

If these directions do not match for your display, you may have an older version. If so, call our service department for assistance (see Section 2.5).

11 Warranty Information

	Frame	Drive, Belt, Motor	Remaining Parts	Labor
Home Use	15 years	5 years	5 years	3 years
Medical Use	10 years	5 years	3 years	1 year
Commercial Use	10 years	5 years	3 years	1 year

WOODWAY warrants that all products and accessories will be free from manufacturing defects according to the applications/terms listed above. The warranty period commences on the original date of purchase (with the exception of the running belt component, which is warranted for a period of four (4) years from the original date of purchase). This warranty is given only to the original purchaser. This warranty does not cover damage or equipment failure resulting from misuse, abuse, or failure to comply with electrical codes. Further, this warranty shall not apply if there is any modification to the products or accessories or if there is a failure to provide maintenance as outlined in the Owner's Manual.

WOODWAY GIVES NO OTHER WARRANTIES, EITHER EXPRESSED OR IMPLIED. THE WARRANTY OF FITNESS FOR A PARTICULAR USE IS HEREBY DISCLAIMED.

The buyer's remedy for breach of the expressed warranties contained herein shall be limited to the return of the product and accessories and repayment of the original purchase price. However, provided at WOODWAY selection, it may repair and replace the non-conforming goods or parts. WOODWAY shall not be liable for any incidental or consequential damages.

Our Guarantee

WOODWAY guarantees the repurchase of WOODWAY treadmill products for a period of up to five (5) years after original installation. A direct payment, or credit toward the purchase of a new WOODWAY, of 20% of the purchase price of the treadmill will be made to the original owner of a WOODWAY treadmill. This guarantee is limited to the original owner. Contact WOODWAY for further details.

13 Disposal

Electrical and electronic devices must be disposed of separately from normal household waste.

An appropriate waste disposal company should be contacted. Properly dispose of the device at the end of its service life (e.g. the local collection point for waste separation):



- The device packaging is disposed of through resource recycling.
- The metal parts of the machine go to scrap metal disposal.
- Plastic parts are given to plastic recycling.
- Rubber parts are disposed of as hazardous waste.



The disposal of the equipment must be in accordance with the respective national regulations.

Wear parts are considered hazardous waste. After being replaced, wear parts must be disposed of according to country-specific waste laws.



Batteries may not be disposed of in household trash. Dispose of them at a battery collection point.



14 Table of Figures

Fig. 1	EC Declaration of Conformity	20
Fig. 2	Name plate	21
Fig. 3	4Front dimensions	27
Fig. 4	Desmo dimensions.....	27
Fig. 5	ELG dimensions	28
Fig. 6	Mercury dimensions	28
Fig. 7	Path dimensions	29
Fig. 8	Pro dimensions.....	29
Fig. 9	Pro XL dimensions	30
Fig. 10	Carrying poles	35
Fig. 11	Ports to insert carrying poles	35
Fig. 12	Power console	38
Fig. 13	Set-up, clearances	42
Fig. 14	Removing Side Covers.....	43
Fig. 15	4Front assembly, side panel	44
Fig. 16	4Front assembly, wiring	45
Fig. 17	4Front assembly, tube mount	45
Fig. 18	4Front assembly, inserting tubes.....	45
Fig. 19	4Front assembly, connection 1.....	46
Fig. 20	4Front assembly, connection 2.....	46
Fig. 21	4Front assembly, connection 3.....	46
Fig. 22	4Front assembly, securing the railing	47
Fig. 23	4Front assembly, side panel	47
Fig. 24	Desmo assembly, removing side covers.....	48
Fig. 25	Desmo assembly, wiring.....	48
Fig. 26	Desmo assembly, tube mount.....	48
Fig. 27	Desmo assembly, inserting tubes	49
Fig. 28	Desmo assembly, fixing the railing	49
Fig. 29	Desmo assembly, electronic cover plate.....	49
Fig. 30	Desmo assembly, connection 1	50
Fig. 31	Desmo assembly, connection 2	50
Fig. 32	Desmo assembly, connection 3	50
Fig. 33	Desmo assembly, connection 4	51
Fig. 34	Desmo assembly, electronic cover plate.....	51
Fig. 35	Desmo assembly, side covers	51
Fig. 36	Desmo assembly, adjusting side covers	52
Fig. 37	Mercury/Path assembly, side covers	52
Fig. 38	Mercury/Path assembly, wiring	52
Fig. 39	Mercury/Path assembly, tube mount	53
Fig. 40	Mercury/Path assembly, insert tubes	53
Fig. 41	Mercury/Path assembly, fixing the railing	53
Fig. 42	Mercury/Path assembly, electronic cover plate	54
Fig. 43	Mercury/Path assembly, connection 1.....	54
Fig. 44	Mercury/Path assembly, connection 2.....	54
Fig. 45	Mercury/Path assembly, connection 3.....	55
Fig. 46	Mercury/Path assembly, connection 4.....	55
Fig. 47	Mercury/Path Assembly, electronic cover plate	55
Fig. 48	Mercury/Path assembly, side covers	56
Fig. 49	Mercury/Path assembly, cover plates.....	56
Fig. 50	Mercury/Path assembly, cover plates.....	56
Fig. 51	Pro/Pro XL assembly, side covers	57

Fig. 52	Pro/Pro XL assembly, wiring.....	57
Fig. 53	Pro/Pro XL assembly, insert railing	57
Fig. 54	Pro/Pro XL assembly, fixing the railing 1	58
Fig. 55	Pro/Pro XL assembly, connection 1	58
Fig. 56	Pro/Pro XL assembly, connection 2.....	58
Fig. 57	Pro/Pro XL assembly, fixing the railing 2	58
Fig. 58	Pro/Pro XL assembly, side covers	59
Fig. 59	Chest strap with POLAR® transmitter	64
Fig. 60	ON/OFF switch.....	65
Fig. 61	Standard display I	66
Fig. 62	Standard display II.....	67
Fig. 63	Standard display III	67
Fig. 64	Group Training Display	68
Fig. 65	Personal trainer display I.....	70
Fig. 66	Personal trainer display II	71
Fig. 67	Personal trainer display III	71
Fig. 68	User-defined track.....	73
Fig. 69	Fitness Programs menu - Heart Rate Control.....	75
Fig. 70	Live data screen - Heart Rate Control	76
Fig. 71	Heart Rate Control - Incline Only.....	76
Fig. 72	Heart Rate Control - Speed Only	77
Fig. 73	Heart Rate Control - Both	78
Fig. 74	Fitness Programs menu and data entry - Goal	80
Fig. 75	Fitness Program level outline – Goal	81
Fig. 76	Fitness Programs menu and data entry – Weight Loss	82
Fig. 77	Fitness Program level outline – Weight Loss	83
Fig. 78	Fitness Programs menu and data entry – Aerobic	84
Fig. 79	Fitness Program level outline – Aerobic.....	85
Fig. 80	Fitness Programs menu – Interval	86
Fig. 81	Data entry – Interval	86
Fig. 82	Live data screen – Interval.....	87
Fig. 83	Fitness Programs menu and data entry – Random	88
Fig. 84	Fitness Program level outline – Random.....	89
Fig. 85	Fitness Programs menu and data entry – Stamina	90
Fig. 86	Fitness Program level outline – Stamina.....	91
Fig. 87	Fitness Programs menu and data entry – Ramp.....	92
Fig. 88	Fitness Program Level Outline – Ramp.....	93
Fig. 89	Fitness Programs menu and data entry – 5K	94
Fig. 90	Fitness Program Level Outline, 5K	95
Fig. 91	Fitness Programs menu and data entry – 10K	96
Fig. 92	Fitness Program Level Outline – 10K.....	97
Fig. 93	Fitness programs screen	98
Fig. 94	Edit fitness program name screen	98
Fig. 95	Edit fitness program screen	99
Fig. 96	Example of customized fitness program screen.....	99
Fig. 97	USB compatibility displays.....	106
Fig. 98	Importing workout data to Excel	107
Fig. 99	Input menu	110
Fig. 100	TV Menu screen	110
Fig. 101	Channel submenu	111
Fig. 102	AutoScan option.....	111
Fig. 103	Are you sure pop up.....	112
Fig. 104	AutoScan progress	112
Fig. 105	Setup menu.....	113
Fig. 106	Closed caption option	113

Fig. 107	Closed caption selection screen.....	114
Fig. 108	CC Mode ON/OFF.....	114
Fig. 109	TV configuration screen, Europe	115
Fig. 110	TV source screen, auto tuning	115
Fig. 111	TV source screen, tuning menu.....	116
Fig. 112	TV source screen, country selection	116
Fig. 113	TV channel tuning screen	117
Fig. 114	Lubrication, axle bearing	121
Fig. 115	Lubrication, drive axle	122
Fig. 116	Lubrication, toothed belts	122
Fig. 117	Lubrication, incline system.....	123
Fig. 118	Device fuses.....	127