



The hygiene and
transfer specialist.
2024





The hygiene and transfer specialist for optimal comfort.

Content

Introduction	05
Shower-toilet chairs	07
Shower trolleys	20
Shower stretchers	25
Dressing tables	26
Active standup aid	27
Added value table	30
Accessories for shower-toilet chairs	34





**Designed for a
positive shower
experience.**

Transforming the shower experience - protecting the caregiver

Lopital products are designed to provide a positive showering experience, and reduce injuries for the caregiver.

Lopital's complete range of showering solutions assists you in improving outcomes.

In order to prevent cross contamination, our products are provided with an antibacterial coating by means of the addition of silver ions. Furthermore, it is important that after showering all the aids can be easily cleaned and disinfected. The products by Lopital have been designed in such a way that they meet these requirements.

The resident enjoys comfort and dignity and the caregiver benefits from the improved safety and ergonomics of the Lopital product. This leads to a higher quality of care and a superior showering and hygiene experience for your residents.

Reduce cross contamination

Quality of life

Positive clinical outcomes

Safety and ergonomics



Everybody involved in the caregiving venue strives for a positive outcome for their client or resident. When you bring all the factors identified above together with the proper tools, Lopital empowers you to improve outcomes and enhance your overall quality of care.

Your showering and hygiene equipment should reduce lost time injuries and the cost of care for your facility. Lopital integrates into your safe client handling program through the thoughtful ergonomic design of our products.



Made in Holland: Guaranteed Quality

All our products are designed and manufactured in the Netherlands, ensuring top-notch quality and craftsmanship. And we take great pride in this. Furthermore, we provide a 60-month warranty on all our products, ensuring your peace of mind and satisfaction with your purchase.



**Only the best products.
Quality and safety
always come first.**

Comfortable showering

A shower chair provides support and ensures a higher level of safety when taking a shower. This product gives some clients greater independence.

This product allows them to care for themselves independently or partially independently. A shower chair facilitates easier care of other clients.

Lopital offers fixed and mobile shower-toilet chairs. Whether a shower stool or a toilet chair is used, we believe it is important that the users experience security and comfort.

Taking care of clients using traditional shower-toilet chairs is very cumbersome. The caregivers will be forced to stand in an

unnatural position and have to cope with static back strain.

Lopital provides a solution to this problem with the height-adjustable shower-toilet chairs. With this feature, we also make an important contribution to occupational health and safety policy within the healthcare sector.

Well-developed hygiene products that allow safe and comfortable showering.

For more information visit our website www.lopital.com



All of the aids produced by Lopital fulfil the following norms for medical products Class 1 (MDR (EU) 2017/745)

5100 5100
Nemo

Suitable for people with a mild to severe disability



Tilting function up to 30° backwards.

Safe, hygienic and comfortable.
Easy to tilt for optimal care.

See page 34 for additional accessories.



Control handle for tilting system.



Standard equipped with a head / neck support. Adjustable in height and depth.



Option: Adjustable comfort leg supports (Product no. 6960 8026).

Technical specifications

Product no.	Product description	Outside depth	Outside width	Inside seat depth	Inside seat width	Seat height	Max. load kg	Max. load lbs	Product weight in kg	Product weight in lbs	Tilt
5100 5100	Nemo shower-toilet chair	100	66	44	47	54	150	330	24	53	30°

All measurements in this matrix are in centimeters.

5100 5199
Flexo

Suitable for people with a mild to severe disability



Technical specifications

Product no.	Product description	Outside depth	Outside width	Inside seat depth	Inside seat width	Seat height adjustment	Max. load kg	Max. load lbs	Product weight in kg	Product weight in lbs	Tilt
5100 5199	Flexo shower-toilet chair	104	73	44	47	50 - 105	150	330	38	84	20°

All measurements in this matrix are in centimeters.

Functional and simple since 1993.

See page 34 for additional accessories.



Option: Head / neck support.



High / low control by foot pump.



Option: Straight armrests.



Option: Adjustable comfort leg supports (Product no. 6960 8026).

5100 5500
Elexo

Suitable for people with a mild to severe disability



Shock-free and comfortable height adjustment.

See page 34 for additional accessories.



Independent, fold-up upholstered armrests with front lock.



Option: Head / neck support.



Option: Adjustable comfort leg supports (Product no. 6960 8026).



Charging point with magnetic coupling, no separate battery required.

Technical specifications

Product no.	Product description	Outside depth	Outside width	Inside seat depth	Inside seat width	Seat height adjustment	Max. load kg	Max. load lbs	Product weight in kg	Product weight in lbs	Tilt
5100 5500	Elexo shower-toilet chair	104	70	44	47	50 - 105	180	400	47	104	20°

All measurements in this matrix are in centimeters.

5100 5300
Elexo XXL

Suitable for people with a moderate to severe disability



Technical specifications

Product no.	Product description	Outside depth	Outside width	Inside seat depth	Inside seat width	Seat height adjustment	Max. load kg	Max. load lbs	Product weight in kg	Product weight in lbs	Tilt
5100 5300	Elexo XXL shower-toilet chair	119	89	54	70	50 - 105	220	485	71	157	20°

All measurements in this matrix are in centimeters.

Because good hygiene must also be accessible to obese clients.

See page 34 for additional accessories.



Two parted seat with front and back openings. Easy removable snaplock seat.



Swing-out and removable footrests. Height adjustable. Extended fully swing-out armrests.

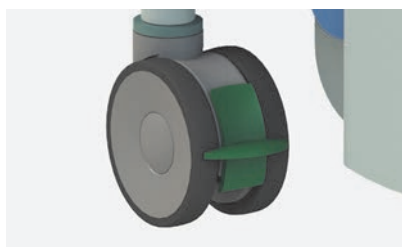

Fitted with a directional wheel.



Option: Head / neck support.

5100 5600

Reflex with height adjustable footrests

Suitable for people with a moderate to very severe disability



Optimal comfort for both caregivers and clients.

See page 34 for additional accessories.



With height adjustable footrests.



Charging point with magnetic coupling, no separate battery required.



Easy-to-use touch controls in the backrest.

Technical specifications

Product no.	Product description	Outside depth	Outside width	Inside seat depth	Inside seat width	Seat height adjustment	Height adjustable footrests	Max. load kg	Max. load lbs	Product weight in kg	Product weight in lbs	Tilt
5100 5600	Reflex shower-toilet chair with height adjustable footrests	106	70	44	47	50 - 100	25	135	300	53	117	30°

All measurements in this matrix are in centimeters.

5100 5605 Reflex

Suitable for people with a moderate to very severe disability



Technical specifications

Product no.	Product description	Outside depth	Outside width	Inside seat depth	Inside seat width	Seat height adjustment	Max. load kg	Max. load lbs	Product weight in kg	Product weight in lbs	Tilt
5100 5605	Reflex shower-toilet chair	116	70	44	47	50 - 100	135	300	53	117	30°

All measurements in this matrix are in centimeters.

Even more possibilities with the Reflex.

See page 34 for additional accessories.



Option: Adjustable comfort leg supports (Product no. 6960 8026).



Independent, fold-up upholstered armrests with front lock.



Foldable and swing-out footrests.



FLEXO?

The chair will reach a maximum inclination of 20° in the highest position

Maximum load 150 kg

Upholstered seat with seat opening

Upholstered frontlocking foldable armrests

Rail for toilet bucket or bedpan

Simple adjustable hydraulic height control

Four double-brake castors

Foldable footrests with calf pads

Footrests touch the ground when in the lowest position



OR REFLEX?

Upholstered frontlocking foldable armrests

Head / neck support, height and depth-adjustable

Upholstered seat with seat opening

Easy-to-use touch controls on backrest

Height-adjustable legrest and calf protection

Rail for toilet bucket or bedpan

Electrically operated tilt mechanism

Electrically operated height adjustment

Emergency lowering device

Four double-brake castors

Maximum load 135 kg

reflex

5100 5700

Tango

Suitable for people with a very mild to moderate disability



Technical specifications

Product no.	Product description	Outside depth	Outside width	Inside seat depth	Inside seat width	Seat height	Max. load kg	Max. load lbs	Product weight in kg	Product weight in lbs
5100 5700	Tango shower-toilet chair	84	66	44	47	55	180	400	19	42

All measurements in this matrix are in centimeters.

Functional and simple.

See page 34 for additional accessories.



Foldable armrests.



Foldable and swing-out footrests.



PU seat with toilet opening.



Option: Holder disposable Bedpan (Product no. 6950 1110).

5100 5705

Tango XL

Suitable for people with a very mild to moderate disability



Technical specifications

Product no.	Product description	Outside depth	Outside width	Inside seat depth	Inside seat width	Seat height	Max. load kg	Max. load lbs	Product weight in kg	Product weight in lbs
5100 5705	Tango XL shower-toilet chair	100	69	47	56	53	250	550	24	53

All measurements in this matrix are in centimeters.

Suitable for obese clients up to 550 lbs / 250 kg.

See page 34 for additional accessories.



Two parted seat with front and back openings. Easy removable snaplock seat.

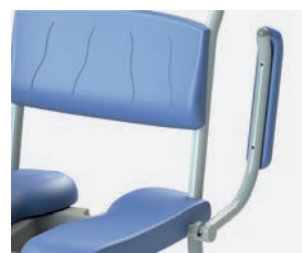

Foldable armrests.



Swing-out and removable footrests. Height adjustable.



Option: Adjustable comfort leg supports (Product no. 6960 8026).

5100 5800

Tango XXL

Suitable for people with a very mild to moderate disability

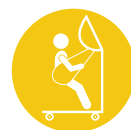

Safe and comfortable care of obese clients.

See page 34 for additional accessories.



Swing-out and removable footrests. Height adjustable. Extended fully swing-out armrests.



Two parted seat with front and back openings. Easy removable snaplock seat.



Suitable for obese clients up to 800 lbs / 360 kg.

Technical specifications

Product no.	Product description	Outside depth	Outside width	Inside seat depth	Inside seat width	Seat height	Max. load kg	Max. load lbs	Product weight in kg	Product weight in lbs
5100 5800	Tango XXL shower-toilet chair	97	83	54	70	51	360	800	31	68

All measurements in this matrix are in centimeters.

Timo

Suitable for people with a very mild to moderate disability



Technical specifications

Product no.	Product description	Outside depth	Outside width	Inside seat depth	Inside seat width	Seat height	Max. load kg	Max. load lbs	Product weight in kg	Product weight in lbs
5400 6025	Timo shower chair	63	57	49	47	50	135	300	15	33
5400 6030	Timo shower-toilet chair	63	57	49	47	54	135	300	15	33
5400 6035	Timo shower-toilet chair + footrests	91	57	49	47	54	135	300	16	35

All measurements in this matrix are in centimeters.



5400 6025
Timo shower chair



5400 6030
Timo shower-toilet chair

Safe, hygienic and comfortable.

See page 34 for additional accessories.



Swing-out and removable footrests.



Easy removable snap lock seat.

5400 6035
Timo shower-toilet chair + footrests



**Continuous innovation
and development.**

Showering in a supine position

For some people with a disability, it is more pleasant or better to be washed and taken care of in a lying position. Our shower trolley / stretcher allows this. This enables an immobile person to be cared for in comfort.

The correct shower trolley / stretcher will ensure that the caregiver has greater freedom of movement, can work closer to the client and that the work causes less strain. It also enables the client to play a more active role in his or her personal care.

Depending on the space that is available and the needs, you can choose from mobile shower trolleys and wall-mounted stretchers. There is also a choice between electric and hydraulic

height-adjustable shower trolleys / stretchers. In specific situations we can customise a shower stretcher according to your personal wishes.

One of the benefits of a mobile (height adjustable) shower trolley is that the number of transfers can be reduced. The trolley can be placed immediately next to the bed and adjusted to the required height. This enables a simple horizontal transfer using simple tools.

For more information visit our website www.lophospital.com

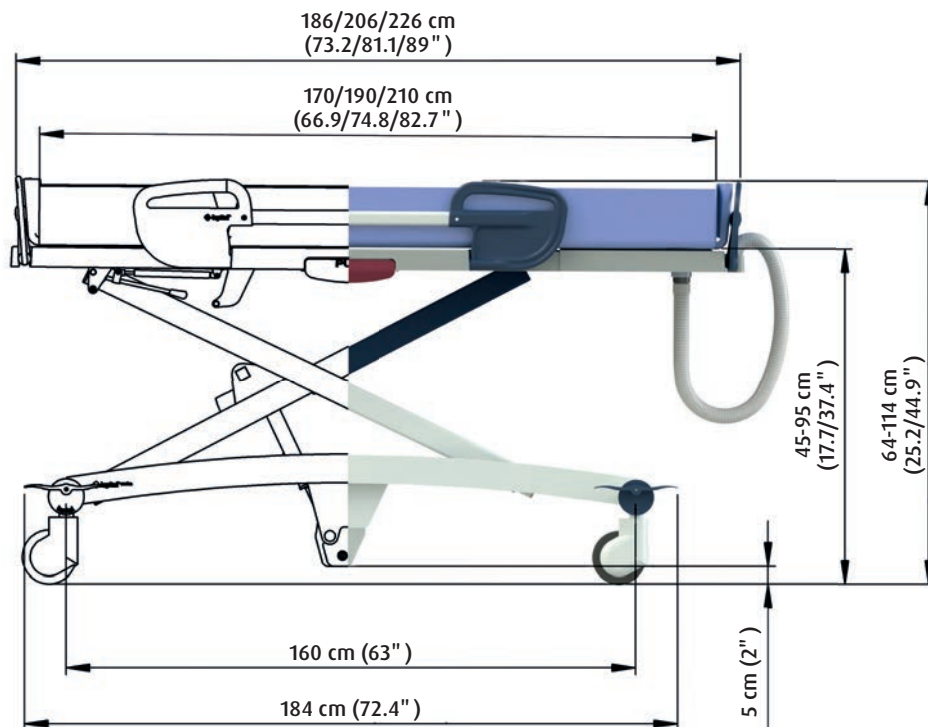

6100 2010 / 6100 2060

Marina deluxe

Suitable for people with a severe to very severe disability



Marina deluxe hydraulic.



Marina deluxe electric.



Electric or by means of a gas spring back adjustment (Marina deluxe).



Half-central braking system (Marina deluxe).



Side rail with lowered middle section for providing optimum care (Marina deluxe & basic).

Technical specifications

Product no.	Product description	Outside length	Outside width	Inside length	Inside width	Lying surface height adjustment	Max. load kg	Max. load lbs	Product weight in kg	Product weight in lbs
6100 2010	Marina deluxe shower trolley hydraulic	186 206 226	81	170 190 210	70-80	45-95	227	500	80	176
6100 2060	Marina deluxe shower trolley electric	186 206 226	81	170 190 210	70-80	45-95	227	500	80	176
6720 0010	Mattress 186 deluxe	-	-	170	70	-	-	-	-	-
6720 0020	Mattress 206 deluxe	-	-	190	70	-	-	-	-	-
6720 0030	Mattress 226	-	-	210	70	-	-	-	-	-

All measurements in this matrix are in centimeters.

6100 2000 / 6100 2050

Marina basic

Suitable for people with a severe to very severe disability



Light, comfortable and versatile in use.

Shower trolleys



Marina basic electric.



Marina basic hydraulic.



With a standard built-in length adjustment (Marina deluxe & basic).



Angled position (Anti-Trendelenburg) (Marina deluxe & basic).



Control box emergency stop (Marina deluxe & basic electric).

Technical specifications

Product no.	Product description	Outside length	Outside width	Inside length	Inside width	Lying sur-face height adjustment	Max. load kg	Max. load lbs	Product weight in kg	Product weight in lbs
6100 2000	Marina basic shower trolley hydraulic	186 206 226	81	170 190 210	70-80	45-95	227	500	76	168
6100 2050	Marina basic shower trolley electric	186 206 226	81	170 190 210	70-80	45-95	227	500	76	168
6720 0005	Mattress 186 basic	-	-	170	70	-	-	-	-	-
6720 0015	Mattress 206 basic	-	-	190	70	-	-	-	-	-
6720 0030	Mattress 226	-	-	210	70	-	-	-	-	-

All measurements in this matrix are in centimeters.

6200 4015

Amfora

Suitable for people with a moderate to very severe disability



6200 4015
Amfora shower trolley
hydraulic height adjustment
with collection tray

Technical specifications

Product no.	Product description	Outside length	Outside width	Inside length	Inside width	Lying sur-face height adjustment	Max. load kg	Max. load lbs	Product weight in kg	Product weight in lbs
6200 4015	Amfora shower trolley hydraulic 190 with collection tray	190	82	180	70	50 - 100	150	330	63	139

All measurements in this matrix are in centimeters.

6100 2500 / 6100 2510

Sirocco deluxe & basic

Suitable for people with a severe to very severe disability



Technical specifications

Product no.	Product description	Outside length	Outside width	Inside length	Inside width	Lying surface height adjustment	Max. load kg	Max. load lbs	Product weight in kg	Product weight in lbs
6100 2500	Sirocco basic shower stretcher wall-mounted	186 206	95	170 190	70 - 75	45 - 95	227	500	71	157
6100 2510	Sirocco deluxe shower stretcher wall-mounted	186 206	95	170 190	70 - 75	45 - 95	227	500	73	161
6720 0005	Mattress 186 basic	-	-	170	70	-	-	-	-	-
6720 0015	Mattress 206 basic	-	-	190	70	-	-	-	-	-
6720 0010	Mattress 186 deluxe	-	-	170	70	-	-	-	-	-
6720 0020	Mattress 206 deluxe	-	-	190	70	-	-	-	-	-

All measurements in this matrix are in centimeters.



With a standard built-in length adjustment (Sirocco basic & deluxe)

6100 2500

Sirocco basic shower stretcher
wall-mounted

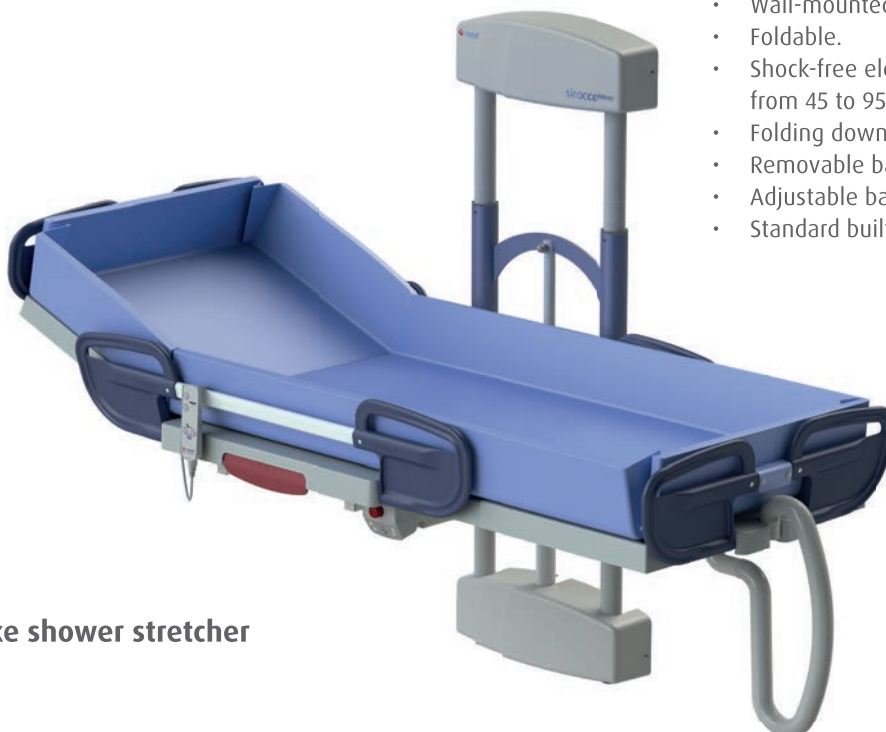

- Wall-mounted.
- Foldable.
- Shock-free electric adjustment from 45 to 95 cm.
- Folding down side rail.
- Removable battery.
- Adjustable backrest (6100 2510).
- Standard built-in length adjustment.

6100 2510

Sirocco deluxe shower stretcher
wall-mounted

6500 4025 / 6500 5030

Vienna

Suitable for people with a moderate to very severe disability



Technical specifications

Product no.	Product description	Outside length	Outside width	Inside length	Inside width	Lying surface height adjustment	Max. load kg	Max. load lb	Product weight in kg	Product weight in lbs
6500 4025	Vienna dressing table hydr 190	190	82	-	70	56 - 106	150	330	59	130
6500 5030	Vienna dressing table wall-mounted	190	91	-	70	45 - 95	227	500	70	154

All measurements in this matrix are in centimeters.

Simple operation improves ease of use.



6500 5030
Vienna dressing table
Wall-mounted



6500 4025
Vienna dressing table
hydraulic

A caregiver in a white uniform is assisting an elderly woman in using a blue Lotus standup aid. The woman is wearing a pink shirt and dark pants. The caregiver is holding the blue handle of the device, which is designed to help the woman rise from a seated position. The background is a white tiled wall.

**Lotus.
Simply rise up.**

5900 8200 Lotus / 5900 8250 Lotus Compact

Lotus

Suitable for people with a mild to moderate disability



5900 8200 Lotus

- Maximum load capacity of 200 kg
- Rotating seat sections
- Mechanical leg spreading
- Wheel locking
- Variable contact points
- Comfortable lower leg supports
- Ideal seating angle
- Convenient maneuvering handle
- Smooth rotating joints
- Sturdy footplate
- 2 Plastic lockable swivel wheels

Technical specifications

Product no.	Product description	Material	Lifting capacity kg	Lifting capacity lbs	Length x width x height	Width legs	Mechanical base spreading	Weight kg	Weight lbs	Client length
5900 8200	Lotus active	steel	200	440	96 x 68 x 110	68	68 - 96	32	77	1,60 - 1,95 m
5900 8250	Lotus active Compact	steel	200	440	96 x 68 x 101	68	68 - 96	32	77	1,30 - 1,65 m

All measurements in this matrix are in centimeters.

Suitable for people with a mild to moderate disability



Lotus.
Simply rise up.



5900 8250 Lotus Compact

Active standup aid



Rotating Seat parts.



Mechanical base spreading.



Wheel Locking.



Variable Contact Points

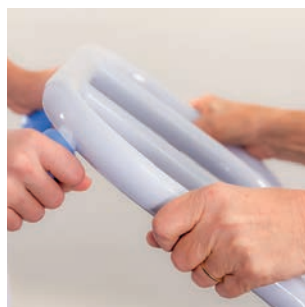

Comfortable lower leg support.

Added value table shower-toilet chairs

Product no.	Product description	Adjustable hydraulic/ electric or fixed	Mobile	Height adjustable	Head / neck support	Tilt mechanism	Shower	Toilet	Comfort PUR	Tech. lifespan min. 10 years*	Removable snaplock seat	Armrests with front locking	Can be wheeled over toilet	Obesity
5100 5100	Nemo shower-toilet chair	pneumatic	•		•	•	•	•	•	•		option	•	
5100 5199	Flexo shower-toilet chair	hydraulic	•	•	option	•	•	•	•	•		•	•	
5100 5500	Elexo shower-toilet chair	electric	•	•	option	•	•	•	•	•		•	•	
5100 5300	Elexo XXL shower-toilet chair	electric	•	•	option	•	•	•	•	•	•		•	•
5100 5600	Reflex shower-toilet chair with height adjustable footrests	electric	•	•	•	•	•	•	•	•		•	•	
5100 5605	Reflex shower-toilet chair	electric	•	•	•	•	•	•	•	•		•	•	
5100 5700	Tango shower-toilet chair	fixed	•		option		•	•	•	•		option	•	

For instruction and demonstration go to: www.lopital.com/videos



5100 5100
Nemo shower-toilet chair



5100 5199
Flexo shower-toilet chair



5100 5500
Elexo shower-toilet chair



5100 5300
Elexo XXL shower-toilet chair



5100 5600
Reflex shower-toilet chair with height adjustable footrests



5100 5605
Reflex shower-toilet chair



5100 5700
Tango shower-toilet chair

Product no.	Product description	Adjustable hydraulic/ electric or fixed	Mobile	Height adjustable	Head / neck support	Tilt mechanism	Shower	Toilet	Comfort PUR	Removable snaplock seat	Tech. lifespan min. 10 years*	Armrests with front locking	Can be wheeled over toilet	Obesity
5100 5705	Tango XL shower-toilet chair	fixed	•		option		•	•	•	•	•		•	•
5100 5800	Tango XXL shower-toilet chair	fixed	•		option		•	•	•	•	•		•	•
5400 6025	Timo shower chair	fixed	•				•		•	•	•	option		
5400 6030	Timo shower-toilet chair	fixed	•				•	•	•	•	•	option	•	
5400 6035	Timo shower-toilet chair + footrests	fixed	•				•	•	•	•	•	option	•	

For instruction and demonstration go to: www.lopital.com/videos



5100 5705
Tango XL shower-toilet chair



5100 5800
Tango XXL shower-toilet chair



5400 6025
Timo shower chair



5400 6030
Timo shower-toilet chair



5400 6035
Timo shower-toilet chair + footrests

* Technical life span is only guaranteed with correct use and maintenance in accordance with the supplier's instructions.

Added value table shower trolleys, shower stretchers & dressing tables



6100 2010
Marina deluxe shower trolley
hydraulic height adjustment



6100 2060
Marina deluxe shower trolley
electric height adjustment



6100 2000
Marina basic shower trolley
hydraulic height adjustment



6100 2050
Marina basic shower trolley
electric height adjustment



6100 2500
**Sirocco basic shower
stretcher**
Wall-mounted



6100 2510
**Sirocco deluxe shower
stretcher**
Wall-mounted



6500 5030
Vienna dressing table
Wall-mounted



6500 4025
Vienna dressing table
hydraulic



6200 4015
Amfora shower trolley
hydraulic



Product no.	Product description	Adjustable hydraulic / electric or fixed	Mobile	Height adjustable	Tilt mechanism	Adjustable backrest	Half central braking system	Vertical height adjustment	Extra external battery pack	Tech. lifespan min. 10 years*	Aluminum light weight	Wall mounted	Obesity
6100 2010	Marina deluxe shower trolley hydraulic	hydraulic	•	•	•	•	•	•		•	•		•
6100 2060	Marina deluxe shower trolley electric	electric	•	•	•	•	•	•	option	•	•		•
6100 2000	Marina basic shower trolley hydraulic	hydraulic	•	•	•			•		•	•		•
6100 2050	Marina basic shower trolley electric	electric	•	•	•			•	option	•	•		•
6100 2500	Sirocco basic shower stretcher wall-mounted	electric		•				•	option	•		•	
6100 2510	Sirocco deluxe shower stretcher wall-mounted	electric		•		•		•	option	•		•	
6200 4015	Amfora shower trolley hydr. 190 with collection tray	hydraulic	•	•		•				•			
6500 4025	Vienna dressing table hydraulic	hydraulic	•	•		•				•	•		
6500 5030	Vienna dressing table wall-mounted	electric		•		•		•	option	•	•	•	

For instruction and demonstration go to: www.lopital.com/videos

*Technical life span is only guaranteed with correct use and maintenance in accordance with the supplier's instructions.

Accessories for shower-toilet chairs

Product no.	Product description	Nemo	Flexo	Elexo	Elexo XXL	Reflex 5100 5600	Reflex 5100 5605	Mylo	Tango	Tango XL	Tango XXL
6840 5500	Head / neck support		•	•	•			•	•	•	•
6840 5661	Dual locking armrests	•	•	•		•	•	•	•		
6975 8044	Safety seatbelt	•	•	•	•	•	•	•	•	•	•
6950 1104	Commode pan and lid	•	•	•	•	•	•	•	•	•	•
6950 1110	Holder for disposable bedpan	•	•	•	•	•	•	•	•	•	•
6950 5624	Platilon backrest	•	•	•		•	•	•	•		
6950 5625	Platilon seat	•	•	•		•	•	•	•		
6960 5198	Footrests short	•	•	•	•		•				
6960 8026	Adjustable comfort leg supports	•	•	•			•			•	
6975 8045	Four point safety belt	•	•	•	•	•	•	•	•	•	•
7500 5693	Raising set 10 to 30 mm	•	•	•		•	•	•	•	•	
6840 5678	Reflex back support + separate manual control (wired)					•	•				



6840 5500 / 6840 5510
Head / neck support + holder

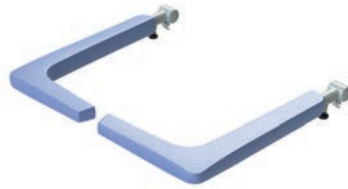

6840 5661
Dual locking armrests



6975 8044
Safety seatbelt



6950 1104
Commode pan and lid



6950 5624 / 6950 5625
Platilon backrest / Platilon seat



6950 1110
Holder for disposable bedpan



6960 8026
Adjustable comfort leg supports



6975 8045
Four point safety belt



7500 5693
Raising set 10 to 30 mm



**More than 40 years
completely focused
on the quality of care.**

